

© Copyright 2004 Fortinet Inc. All rights reserved.

No part of this publication including text, examples, diagrams or illustrations may be reproduced, transmitted, or translated in any form or by any means, electronic, mechanical, manual, optical or otherwise, for any purpose, without prior written permission of Fortinet Inc.

FortiGate-4000 Installation and Configuration Guide

Version 2.50

February 5 2004

Trademarks

Products mentioned in this document are trademarks or registered trademarks of their respective holders.

Regulatory Compliance

FCC Class A Part 15 CSA/CUS

CAUTION: RISK OF EXPLOSION IF BATTERY IS REPLACED BY AN INCORRECT TYPE.
DISPOSE OF USED BATTERIES ACCORDING TO THE INSTRUCTIONS.

For technical support, please visit <http://www.fortinet.com>.

Send information about errors or omissions in this document or any Fortinet technical documentation to techdoc@fortinet.com.

Table of Contents

Introduction	15
Antivirus protection	16
Web content filtering	16
Email filtering	17
Firewall.....	17
NAT/Route mode	18
Transparent mode.....	18
VLANs and virtual domains.....	18
Network intrusion detection.....	18
VPN.....	19
High availability	19
Secure installation, configuration, and management	20
Web-based manager	20
Command line interface	21
Logging and reporting	21
Document conventions	21
Fortinet documentation	22
Comments on Fortinet technical documentation.....	23
Customer service and technical support.....	23
 Getting started	 25
Warnings and cautions	26
Warning.....	26
Package contents	26
Physical description	27
Front panel features.....	28
FortiBlade-4010 module.....	29
KVM switch module	30
Rear panel features	31
Power supplies and power connections.....	32
Cooling fan trays	33
Management module	33
10/100 out of band management module	34
Pass-through interface module	35
Switched interface module.....	36

Installing hardware.....	37
Choosing a suitable environment.....	37
Choosing a rack.....	37
Attaching the mounting rail.....	37
Installing FortiBlade-4010 modules.....	38
FortiGate-4000P network connections.....	39
FortiGate-4000S network connections.....	39
Out of band management connections.....	40
Console management connections.....	40
Turning FortiGate-4000 chassis power on and off.....	40
Turning on FortiGate-4000 chassis power.....	40
Turning off FortiGate-4000 chassis power.....	41
Hot swapping modules.....	41
Hot swapping FortiBlade-4010 modules.....	42
Hot swapping cooling fan trays.....	42
Hot swapping power supplies.....	42
Hot swapping interface modules.....	43
Hot swapping the 10/100 out of band management module.....	43
Hot swapping the management module.....	44
Hot swapping the KVM switch module.....	44
Connecting to the web-based manager.....	44
Connecting to the FortiGate-4000 internal interface module.....	45
Connecting to the FortiGate-4000 10/100 out of band management module.....	46
Connecting to the Command Line Interface (CLI).....	47
Factory default configuration.....	48
Factory default NAT/Route mode network configuration.....	48
Factory default Transparent mode network configuration.....	49
Factory default firewall configuration.....	50
Factory default content profiles.....	51
Planning the FortiGate configuration.....	54
NAT/Route mode standalone configuration.....	54
Transparent mode standalone configuration.....	55
FortiGate-4000 HA configuration.....	56
FortiGate-4000 units with external load balancers.....	57
FortiGate model maximum values matrix.....	59
Next steps.....	60
NAT/Route mode installation.....	61
Preparing to configure NAT/Route mode.....	61
Advanced NAT/Route mode settings.....	62
Out of band management interface.....	63
Using the setup wizard.....	63
Starting the setup wizard.....	63
Reconnecting to the web-based manager.....	63

Using the command line interface.....	64
Configuring the FortiGate unit to operate in NAT/Route mode	64
Configuring the out of band management interface	65
Connecting the FortiGate unit to your networks.....	65
Configuring your networks	66
Completing the configuration	66
Configuring the out of band management interface	66
Setting the date and time	66
Changing antivirus protection	66
Registering your FortiGate unit	67
Configuring virus and attack definition updates	67
Transparent mode installation.....	69
Preparing to configure Transparent mode	69
Out of band management interface	70
Using the setup wizard.....	70
Changing to Transparent mode using the web-based manager	70
Starting the setup wizard	70
Reconnecting to the web-based manager	71
Using the command line interface.....	71
Changing to Transparent mode using the CLI	71
Configuring the Transparent mode management IP address	71
Configure the Transparent mode default gateway	72
Configure the out of band management interface.....	72
Completing the configuration	72
Setting the date and time	72
Enabling antivirus protection.....	72
Registering your FortiGate unit	73
Configuring virus and attack definition updates	73
Connecting the FortiGate unit to your networks.....	73
Transparent mode configuration examples.....	74
Default routes and static routes	74
Example default route to an external network.....	75
Example static route to an external destination	76
Example static route to an internal destination	78
High availability.....	81
Configuring an HA cluster	82
Configuring FortiGate units for HA operation.....	82
Connecting the cluster	84
Adding a new FortiGate unit to a functioning cluster	86

Managing an HA cluster.....	87
Configuring cluster interface monitoring	88
Viewing the status of cluster members	88
Monitoring cluster members.....	89
Viewing cluster sessions.....	90
Viewing and managing cluster log messages.....	90
Monitoring cluster units for failover	91
Viewing cluster communication sessions.....	91
Managing individual cluster units	92
Changing cluster unit host names.....	92
Synchronizing the cluster configuration	93
Upgrading firmware.....	94
Replacing a FortiGate unit after failover	95
Advanced HA options	95
Selecting a FortiGate unit as a permanent primary unit.....	95
Configuring the priority of each FortiGate unit in the cluster.....	96
Configuring weighted-round-robin weights	96
Active-Active cluster packet flow.....	97
NAT/Route mode packet flow	97
Configuring switches to work with a NAT/Route mode cluster	98
Transparent mode packet flow.....	99
System status.....	101
Changing the FortiGate host name.....	102
Changing the FortiGate firmware.....	102
Upgrading to a new firmware version	103
Reverting to a previous firmware version.....	104
Installing firmware images from a system reboot using the CLI	107
Testing a new firmware image before installing it	109
Installing and using a backup firmware image.....	111
Manual virus definition updates	114
Manual attack definition updates	115
Displaying the FortiGate serial number.....	115
Displaying the FortiGate up time.....	115
Backing up system settings	115
Restoring system settings.....	116
Restoring system settings to factory defaults	116
Changing to Transparent mode	117
Changing to NAT/Route mode.....	117
Restarting the FortiGate unit.....	118
Shutting down the FortiGate unit	118

System status	118
Viewing CPU and memory status	119
Viewing sessions and network status	120
Viewing virus and intrusions status	121
Session list.....	122
Virus and attack definitions updates and registration	123
Updating antivirus and attack definitions	123
Connecting to the FortiResponse Distribution Network	124
Manually initiating antivirus and attack definitions updates	125
Configuring update logging	126
Scheduling updates	126
Enabling scheduled updates	126
Adding an override server	127
Enabling scheduled updates through a proxy server	128
Enabling push updates	128
Enabling push updates	129
Push updates when FortiGate IP addresses change	129
Enabling push updates through a NAT device	129
Registering FortiGate units	133
FortiCare Service Contracts	134
Registering the FortiGate unit	134
Updating registration information	136
Recovering a lost Fortinet support password	136
Viewing the list of registered FortiGate units	137
Registering a new FortiGate unit	137
Adding or changing a FortiCare Support Contract number	138
Changing your Fortinet support password	138
Changing your contact information or security question	138
Downloading virus and attack definitions updates	139
Registering a FortiGate unit after an RMA	140

Network configuration..... 141

- Configuring zones 141
 - Adding zones 142
 - Deleting zones 142
- Configuring interfaces 142
 - Viewing the interface list 143
 - Changing the administrative status of an interface 143
 - Adding an interface to a zone 143
 - Configuring an interface with a manual IP address 144
 - Configuring an interface for DHCP 144
 - Configuring an interface for PPPoE 145
 - Adding a secondary IP address to an interface 146
 - Adding a ping server to an interface 146
 - Controlling administrative access to an interface..... 147
 - Changing the MTU size to improve network performance 148
 - Configuring traffic logging for connections to an interface 148
 - Configuring the management interface in Transparent mode..... 148
- Out of band management 149
 - Out of band management interface CLI command 150
- VLAN overview 150
- VLANs in NAT/Route mode 151
 - Rules for VLAN IDs 151
 - Rules for VLAN IP addresses 152
 - Adding VLAN subinterfaces 152
- Virtual domains in Transparent mode 153
 - Virtual domain properties 154
 - Configuring a virtual domain 154
 - Adding firewall policies for virtual domains 157
 - Deleting virtual domains..... 158
- Adding DNS server IP addresses 158
- Configuring routing..... 158
 - Adding a default route 159
 - Adding destination-based routes to the routing table..... 159
 - Adding routes in Transparent mode..... 160
 - Configuring the routing table..... 161
 - Policy routing 161
- Configuring DHCP services 162
 - Configuring a DHCP relay agent..... 163
 - Configuring a DHCP server 163

RIP configuration	167
RIP settings.....	167
Configuring RIP for FortiGate interfaces.....	169
Adding RIP filters	171
Adding a RIP filter list.....	171
Assigning a RIP filter list to the neighbors filter.....	172
Assigning a RIP filter list to the incoming filter	172
Assigning a RIP filter list to the outgoing filter.....	173
 System configuration	 175
Setting system date and time.....	175
Changing system options.....	176
Adding and editing administrator accounts	178
Adding new administrator accounts	178
Editing administrator accounts	179
Configuring SNMP	180
Configuring the FortiGate unit for SNMP monitoring	180
Configuring FortiGate SNMP support	180
FortiGate MIBs.....	182
FortiGate traps	183
Fortinet MIB fields	185
Replacement messages	187
Customizing replacement messages	188
Customizing alert emails	189
 Firewall configuration.....	 191
Default firewall configuration.....	192
Interfaces	192
VLAN subinterfaces	193
Zones	193
Addresses	193
Services	194
Schedules	194
Content profiles.....	194
Adding firewall policies.....	194
Firewall policy options.....	196
Configuring policy lists	200
Policy matching in detail	200
Changing the order of policies in a policy list.....	201
Enabling and disabling policies	201

Addresses	202
Adding addresses	202
Editing addresses	203
Deleting addresses	204
Organizing addresses into address groups	204
Services	205
Predefined services	205
Adding custom TCP and UDP services	208
Adding custom ICMP services	209
Adding custom IP services	209
Grouping services	209
Schedules	210
Creating one-time schedules	211
Creating recurring schedules	212
Adding schedules to policies	213
Virtual IPs	213
Adding static NAT virtual IPs	214
Adding port forwarding virtual IPs	215
Adding policies with virtual IPs	217
IP pools	218
Adding an IP pool	218
IP Pools for firewall policies that use fixed ports	219
IP pools and dynamic NAT	219
IP/MAC binding	220
Configuring IP/MAC binding for packets going through the firewall	220
Configuring IP/MAC binding for packets going to the firewall	221
Adding IP/MAC addresses	221
Viewing the dynamic IP/MAC list	222
Enabling IP/MAC binding	222
Content profiles	223
Default content profiles	224
Adding content profiles	224
Adding content profiles to policies	226

Users and authentication 227

Setting authentication timeout	228
Adding user names and configuring authentication	228
Adding user names and configuring authentication	228
Deleting user names from the internal database	229
Configuring RADIUS support	230
Adding RADIUS servers	230
Deleting RADIUS servers	230

Configuring LDAP support	231
Adding LDAP servers.....	231
Deleting LDAP servers.....	232
Configuring user groups.....	232
Adding user groups.....	233
Deleting user groups.....	234
IPSec VPN.....	235
Key management.....	236
Manual Keys	236
Automatic Internet Key Exchange (AutoIKE) with pre-shared keys or certificates	236
Manual key IPSec VPNs.....	237
General configuration steps for a manual key VPN	237
Adding a manual key VPN tunnel	237
AutoIKE IPSec VPNs.....	239
General configuration steps for an AutoIKE VPN	239
Adding a phase 1 configuration for an AutoIKE VPN.....	239
Adding a phase 2 configuration for an AutoIKE VPN.....	244
Managing digital certificates.....	246
Obtaining a signed local certificate	246
Obtaining CA certificates	249
Configuring encrypt policies.....	249
Adding a source address	250
Adding a destination address.....	251
Adding an encrypt policy.....	251
IPSec VPN concentrators	253
VPN concentrator (hub) general configuration steps	254
Adding a VPN concentrator	255
VPN spoke general configuration steps.....	256
Monitoring and Troubleshooting VPNs	257
Viewing VPN tunnel status.....	257
Viewing dialup VPN connection status	258
Testing a VPN.....	258
PPTP and L2TP VPN.....	259
Configuring PPTP	259
Configuring the FortiGate unit as a PPTP gateway	260
Configuring a Windows 98 client for PPTP	262
Configuring a Windows 2000 client for PPTP	263
Configuring a Windows XP client for PPTP	263
Configuring L2TP	265
Configuring the FortiGate unit as an L2TP gateway	265
Configuring a Windows 2000 client for L2TP	267
Configuring a Windows XP client for L2TP	268

Network Intrusion Detection System (NIDS) 271

- Detecting attacks 271
 - Selecting the interfaces to monitor 272
 - Disabling monitoring interfaces 272
 - Configuring checksum verification 272
 - Viewing the signature list 273
 - Viewing attack descriptions 273
 - Disabling NIDS attack signatures 274
 - Adding user-defined signatures 274
- Preventing attacks 276
 - Enabling NIDS attack prevention 276
 - Enabling NIDS attack prevention signatures 276
 - Setting signature threshold values 277
- Logging attacks 278
 - Logging attack messages to the attack log 278
 - Reducing the number of NIDS attack log and email messages 278

Antivirus protection 281

- General configuration steps 281
- Antivirus scanning 282
- File blocking 283
 - Blocking files in firewall traffic 284
 - Adding file patterns to block 284
- Blocking oversized files and emails 285
 - Configuring limits for oversized files and email 285
- Exempting fragmented email from blocking 285
- Viewing the virus list 286

Web filtering 287

- General configuration steps 287
- Content blocking 288
 - Adding words and phrases to the Banned Word list 288
 - Clearing the Banned Word list 289
 - Backing up the Banned Word list 290
 - Restoring the Banned Word list 290
- URL blocking 291
 - Configuring FortiGate Web URL blocking 291
 - Configuring FortiGate Web pattern blocking 294
- Configuring Cerberian URL filtering 294
 - Installing a Cerberian license key 295
 - Adding a Cerberian user 295
 - Configuring Cerberian web filter 295
 - Enabling Cerberian URL filtering 296

Script filtering	297
Enabling script filtering.....	297
Selecting script filter options	297
Exempt URL list	298
Adding URLs to the URL Exempt list	298
Downloading the URL Exempt List	299
Uploading a URL Exempt List.....	299
Email filter.....	301
General configuration steps	301
Email banned word list.....	302
Adding words and phrases to the email banned word list.....	302
Downloading the email banned word list	303
Uploading the email banned word list.....	303
Email block list	304
Adding address patterns to the email block list.....	304
Downloading the email block list.....	304
Uploading an email block list	305
Email exempt list.....	305
Adding address patterns to the email exempt list	306
Adding a subject tag	306
Logging and reporting.....	307
Recording logs	307
Recording logs on a remote computer.....	308
Recording logs on a NetIQ WebTrends server	308
Recording logs in system memory	309
Log message levels	309
Filtering log messages	310
Configuring traffic logging	311
Enabling traffic logging.....	312
Configuring traffic filter settings.....	313
Adding traffic filter entries	313
Viewing logs saved to memory	314
Viewing logs.....	314
Searching logs	315
Configuring alert email.....	315
Adding alert email addresses.....	316
Testing alert email.....	316
Enabling alert email	317
Glossary	319
Index	323

Antivirus protection

FortiGate ICSA-certified antivirus protection scans web (HTTP), file transfer (FTP), and email (SMTP, POP3, and IMAP) content as it passes through the FortiGate unit. If a virus is found, antivirus protection removes the file containing the virus from the content stream and forwards a replacement message to the intended recipient.

For extra protection, you can configure antivirus protection to block specified file types from passing through the FortiGate unit. You can use the feature to stop files that might contain new viruses.

If the FortiGate unit contains a hard disk, infected or blocked files can be quarantined. The FortiGate administrator can download quarantined files so that they can be virus scanned, cleaned, and forwarded to the intended recipient. You can also configure the FortiGate unit to automatically delete quarantined files after a specified time.

The FortiGate unit can send email alerts to system administrators when it detects and removes a virus from a content stream. The web and email content can be in normal network traffic or encrypted IPSec VPN traffic.

ICSA Labs has certified that FortiGate Antivirus Firewalls:

- detect 100% of the viruses listed in the current In The Wild List (www.wildlist.org),
- detect viruses in compressed files using the PKZip format,
- detect viruses in email that has been encoded using uuencode format,
- detect viruses in email that has been encoded using MIME encoding,
- log all actions taken while scanning.

Web content filtering

FortiGate web content filtering can scan all HTTP content protocol streams for URLs or web page content. If there is a match between a URL on the URL block list, or a web page contains a word or phrase that is in the content block list, the FortiGate unit blocks the web page. The blocked web page is replaced with a message that you can edit using the FortiGate web-based manager.

You can configure URL blocking to block all or some of the pages on a web site. Using this feature, you can deny access to parts of a web site without denying access to it completely.

To prevent unintentionally blocking legitimate web pages, you can add URLs to an exempt list that overrides the URL blocking and content blocking lists.

Web content filtering also includes a script filter feature that can block unsecure web content such as Java applets, cookies, and ActiveX.

You can use the Cerberian URL blocking to block unwanted URLs.

Email filtering

FortiGate email filtering can scan all IMAP and POP3 email content for unwanted senders or unwanted content. If there is a match between a sender address pattern on the email block list, or an email contains a word or phrase in the banned word list, the FortiGate adds an email tag to the subject line of the email. The recipient can use the mail client software to filter messages based on the email tag.

You can configure email blocking to tag email from all or some senders within organizations that are known to send spam email. To prevent unintentionally tagging email from legitimate senders, you can add sender address patterns to an exempt list that overrides the email block and banned words lists.

Firewall

The FortiGate ICSA-certified firewall protects your computer networks from Internet threats. ICSA has granted FortiGate firewalls version 4.0 firewall certification, providing assurance that FortiGate firewalls successfully screen and secure corporate networks against a range of threats from public or other untrusted networks.

After basic installation of the FortiGate unit, the firewall allows users on the protected network to access the Internet while blocking Internet access to internal networks. You can configure the firewall to put controls on access to the Internet from the protected networks and to allow controlled access to internal networks.

FortiGate policies include a range of options that:

- control all incoming and outgoing network traffic,
- control encrypted VPN traffic,
- apply antivirus protection and web content filtering,
- block or allow access for all policy options,
- control when individual policies are in effect,
- accept or deny traffic to and from individual addresses,
- control standard and user defined network services individually or in groups,
- require users to authenticate before gaining access,
- include traffic shaping to set access priorities and guarantee or limit bandwidth for each policy,
- include logging to track connections for individual policies,
- include Network Address Translation (NAT) mode and Route mode policies,
- include mixed NAT and Route mode policies.

The FortiGate firewall can operate in NAT/Route mode or Transparent mode.

NAT/Route mode

In NAT/Route mode, you can create NAT mode policies and Route mode policies.

- NAT mode policies use network address translation to hide the addresses in a more secure network from users in a less secure network.
- Route mode policies accept or deny connections between networks without performing address translation.

Transparent mode

Transparent mode provides the same basic firewall protection as NAT mode. Packets that the FortiGate unit receives are forwarded or blocked according to firewall policies. The FortiGate unit can be inserted in the network at any point without having to make changes to your network or its components. However, VPN and some advanced firewall features are available only in NAT/Route mode.

VLANs and virtual domains

Fortigate Antivirus Firewalls support IEEE 802.1Q-compliant virtual LAN (VLAN) tags. Using VLAN technology, a single FortiGate unit can provide security services to, and control connections between, multiple security domains according to the VLAN IDs added to VLAN packets. The FortiGate unit can recognize VLAN IDs and apply security policies to secure network and IPSec VPN traffic between each security domain. The FortiGate unit can also apply authentication, content filtering, and antivirus protection to VLAN-tagged network and VPN traffic.

The FortiGate unit supports VLANs in NAT/Route and Transparent mode. In NAT/Route mode, you enter VLAN subinterfaces to receive and send VLAN packets. In Transparent mode, you create virtual domains and then add VLAN subinterfaces to those virtual domains.

Network intrusion detection

The FortiGate Network Intrusion Detection System (NIDS) is a real-time network intrusion detection sensor that detects and prevents a variety of suspicious network activity. NIDS uses attack signatures to identify more than 1000 attacks. You can enable and disable the attacks that the NIDS detects. You can also write user-defined detection attack signatures.

NIDS prevention detects and prevents many common denial of service and packet-based attacks. You can enable and disable prevention attack signatures and customize attack signature thresholds and other parameters.

To notify system administrators of the attack, the NIDS records the attack and any suspicious traffic to the attack log, and can be configured to send alert emails.

Fortinet updates NIDS attack definitions periodically. You can download and install updated attack definitions manually or you can configure the FortiGate unit to automatically check for and download attack definition updates.

VPN

Using FortiGate virtual private networking (VPN), you can provide a secure connection between widely separated office networks or securely link telecommuters or travellers to an office network. Service providers can also use the FortiGate unit to provide VPN services for their clients.

FortiGate VPN features include the following:

- Industry standard and ICSA-certified IPSec VPN, including:
 - IPSec, ESP security in tunnel mode,
 - DES, 3DES (triple-DES), and AES hardware accelerated encryption,
 - HMAC MD5 and HMAC SHA1 authentication and data integrity,
 - AutoIKE key based on pre-shared key tunnels,
 - IPSec VPN using local or CA certificates,
 - Manual Keys tunnels,
 - Diffie-Hellman groups 1, 2, and 5,
 - Aggressive and Main Mode,
 - Replay Detection,
 - Perfect Forward Secrecy,
 - XAuth authentication,
 - Dead peer detection.
- PPTP for easy connectivity with the VPN standard supported by the most popular operating systems.
- L2TP for easy connectivity with a more secure VPN standard, also supported by many popular operating systems.
- Firewall policy based control of IPSec VPN traffic.
- IPSec NAT traversal so that remote IPSec VPN gateways or clients behind a NAT can connect to an IPSec VPN tunnel.
- VPN hub and spoke using a VPN concentrator to allow VPN traffic to pass from one tunnel to another through the FortiGate unit.
- IPSec Redundancy to create a redundant AutoIKE key IPSec VPN connection to a remote network.

High availability

High Availability (HA) provides failover between two or more FortiGate units. Fortinet achieves HA by using redundant hardware: matching FortiGate models running in NAT/Route mode. You can configure the FortiGate units for either active-passive (A-P) or active-active (A-A) HA.

Both A-P and A-A HA use similar redundant hardware configurations. High availability software guarantees that if one of the FortiGate units in the HA group fails, all functions, established firewall connections, and IPSec VPN sessions are maintained.

Secure installation, configuration, and management

The first time you power on the FortiGate unit, it is already configured with default IP addresses and security policies. Connect to the web-based manager, set the operating mode, and use the Setup wizard to customize FortiGate IP addresses for your network, and the FortiGate unit is ready to protect your network. You can then use the web-based manager to customize advanced FortiGate features.

Web-based manager

Using HTTP or a secure HTTPS connection from any computer running Internet Explorer, you can configure and manage the FortiGate unit. The web-based manager supports multiple languages. You can configure the FortiGate unit for HTTP and HTTPS administration from any FortiGate interface.

You can use the web-based manager to configure most FortiGate settings. You can also use the web-based manager to monitor the status of the FortiGate unit. Configuration changes made using the web-based manager are effective immediately without resetting the firewall or interrupting service. Once you are satisfied with a configuration, you can download and save it. The saved configuration can be restored at any time.

Figure 1: The FortiGate web-based manager and setup wizard

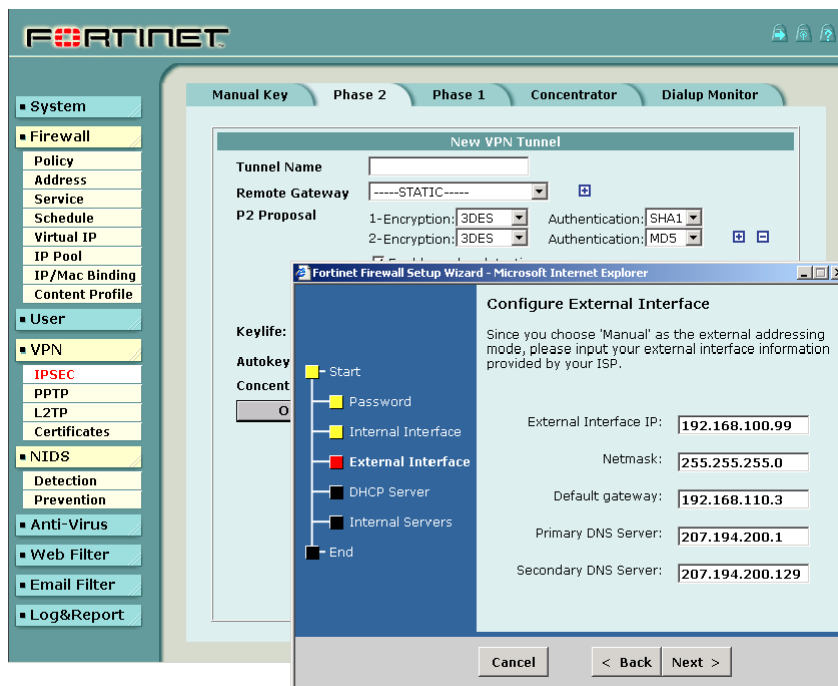

Command line interface

You can access the FortiGate command line interface (CLI) by connecting a management computer serial port to the FortiGate RS-232 serial console connector. You can also use Telnet or a secure SSH connection to connect to the CLI from any network that is connected to the FortiGate unit, including the Internet.

The CLI supports the same configuration and monitoring functionality as the web-based manager. In addition, you can use the CLI for advanced configuration options that are not available from the web-based manager.

This *Installation and Configuration Guide* contains information about basic and advanced CLI commands. For a more complete description about connecting to and using the FortiGate CLI, see the *FortiGate CLI Reference Guide*.

Logging and reporting

The FortiGate unit supports logging for various categories of traffic and configuration changes. You can configure logging to:

- report traffic that connects to the firewall,
- report network services used,
- report traffic that was permitted by firewall policies,
- report traffic that was denied by firewall policies,
- report events such as configuration changes and other management events, IPSec tunnel negotiation, virus detection, attacks, and web page blocking,
- report attacks detected by the NIDS,
- send alert email to system administrators to report virus incidents, intrusions, and firewall or VPN events or violations.

Logs can be sent to a remote syslog server or a WebTrends NetIQ Security Reporting Center and Firewall Suite server using the WebTrends enhanced log format. Some models can also save logs to an optional internal hard drive. If a hard drive is not installed, you can configure most FortiGate units to log the most recent events and attacks detected by the NIDS to the system memory.

Document conventions

This guide uses the following conventions to describe CLI command syntax.

- angle brackets < > to indicate variable keywords

For example:

```
execute restore config <filename_str>
```

You enter `restore config myfile.bak`

<xxx_str> indicates an ASCII string variable keyword.

<xxx_integer> indicates an integer variable keyword.

<xxx_ip> indicates an IP address variable keyword.

- vertical bar and curly brackets { | } to separate alternative, mutually exclusive required keywords

For example:

```
set system opmode {nat | transparent}
```

You can enter `set system opmode nat` or `set system opmode transparent`

- square brackets [] to indicate that a keyword is optional

For example:

```
get firewall ipmacbinding [dhcpiamac]
```

You can enter `get firewall ipmacbinding` or `get firewall ipmacbinding dhcpiamac`

Fortinet documentation

Information about FortiGate products is available from the following FortiGate User Manual volumes:

- *Volume 1: FortiGate Installation and Configuration Guide*

Describes installation and basic configuration for the FortiGate unit. Also describes how to use FortiGate firewall policies to control traffic flow through the FortiGate unit and how to use firewall policies to apply antivirus protection, web content filtering, and email filtering to HTTP, FTP, and email content passing through the FortiGate unit.

- *Volume 2: FortiGate VPN Guide*

Contains in-depth information about FortiGate IPsec VPN using certificates, pre-shared keys and manual keys for encryption. Also contains basic configuration information for the Fortinet Remote VPN Client, detailed configuration information for FortiGate PPTP and L2TP VPN, and VPN configuration examples.

- *Volume 3: FortiGate Content Protection Guide*

Describes how to configure antivirus protection, web content filtering, and email filtering to protect content as it passes through the FortiGate unit.

- *Volume 4: FortiGate NIDS Guide*
Describes how to configure the FortiGate NIDS to detect and protect the FortiGate unit from network-based attacks.
- *Volume 5: FortiGate Logging and Message Reference Guide*
Describes how to configure FortiGate logging and alert email. Also contains the FortiGate log message reference.
- *Volume 6: FortiGate CLI Reference Guide*
Describes the FortiGate CLI and contains a reference to all FortiGate CLI commands.

The FortiGate online help also contains procedures for using the FortiGate web-based manager to configure and manage the FortiGate unit.

Comments on Fortinet technical documentation

You can send information about errors or omissions in this document, or any Fortinet technical documentation, to techdoc@fortinet.com.

Customer service and technical support

For antivirus and attack definition updates, firmware updates, updated product documentation, technical support information, and other resources, please visit the Fortinet technical support web site at <http://support.fortinet.com>.

You can also register FortiGate Antivirus Firewalls from <http://support.fortinet.com> and change your registration information at any time.

Fortinet email support is available from the following addresses:

- | | |
|---|---|
| amer_support@fortinet.com | For customers in the United States, Canada, Mexico, Latin America and South America. |
| apac_support@fortinet.com | For customers in Japan, Korea, China, Hong Kong, Singapore, Malaysia, all other Asian countries, and Australia. |
| eu_support@fortinet.com | For customers in the United Kingdom, Scandinavia, Mainland Europe, Africa, and the Middle East. |

For information on Fortinet telephone support, see <http://support.fortinet.com>.

When requesting technical support, please provide the following information:

- Your name
- Company name
- Location
- Email address
- Telephone number
- FortiGate unit serial number
- FortiGate model
- FortiGate FortiOS firmware version
- Detailed description of the problem

Getting started

This chapter describes unpacking, setting up, and powering on a FortiGate-4000 Antivirus Firewall. When you have completed the procedures in this chapter, you can proceed to one of the following:

- If you are going to operate the FortiGate unit in NAT/Route mode, go to [“NAT/Route mode installation” on page 61](#).
- If you are going to operate the FortiGate unit in Transparent mode, go to [“Transparent mode installation” on page 69](#).
- If you are going to operate two or more FortiGate units in HA mode, go to [“High availability” on page 81](#).

This chapter describes:

- [Warnings and cautions](#)
- [Package contents](#)
- [Physical description](#)
- [Front panel features](#)
- [Rear panel features](#)
- [Installing hardware](#)
- [Turning FortiGate-4000 chassis power on and off](#)
- [Hot swapping modules](#)
- [Connecting to the web-based manager](#)
- [Connecting to the Command Line Interface \(CLI\)](#)
- [Factory default configuration](#)
- [Planning the FortiGate configuration](#)
- [FortiGate model maximum values matrix](#)
- [Next steps](#)

Warnings and cautions

You should be aware of the following cautions and warnings before operating the FortiGate-4000 antivirus firewall.

Warning

Turning off all power switches may not turn off all power to the FortiGate-4000 unit. Disconnect the FortiGate-4000 unit from its power source and from any telecommunications links and networks before installing and removing FortiGate-4000 components or performing other maintenance tasks. Failure to do this can result in personal injury or equipment damage. Some circuitry in the unit may continue to operate even though all power switches are off.

The procedures in this chapter are for qualified technical personnel with experience installing and configuring servers. Read and adhere to all warnings, cautions, and notices in this chapter.



Caution: Electrostatic discharge (ESD) can damage FortiGate-4000 components. You should only perform the procedures described in this chapter from an ESD workstation. If no such station is available, you can provide some ESD protection by wearing an anti-static wrist strap and attaching it to a metal part of the FortiGate-4000 chassis.

Package contents

The FortiGate-4000 package consists of two or more packages. One or more of the packages contains two FortiBlade-4010 modules. Each FortiBlade-4010 module is capable of functioning as a standalone FortiGate-4000 antivirus firewall or being part of a FortiGate-4000 HA cluster.

The other package contains the following components:

- FortiGate-4000 chassis which includes the following components (already installed).
 - One KVM switch module (front panel),
 - Ten FortiGate-4000 empty slot covers (front panel),
 - One management module (rear panel),
 - Seven power supply modules (rear panel),
 - Four cooling fan trays (rear panel),
 - Two pass-through interface modules (FortiGate-4000P rear panel), or
 - Two switched interface modules (FortiGate-4000S rear panel),
 - One 10/100 out of band management module (rear panel).
- Three power cables,
- One RJ-45 to DB-9 serial cable (only the black header works with the FortiGate-4000 unit),
- One mounting rail kit,
- One FortiGate-4000 QuickStart Guide,
- One documentation CD containing Fortinet user documentation.

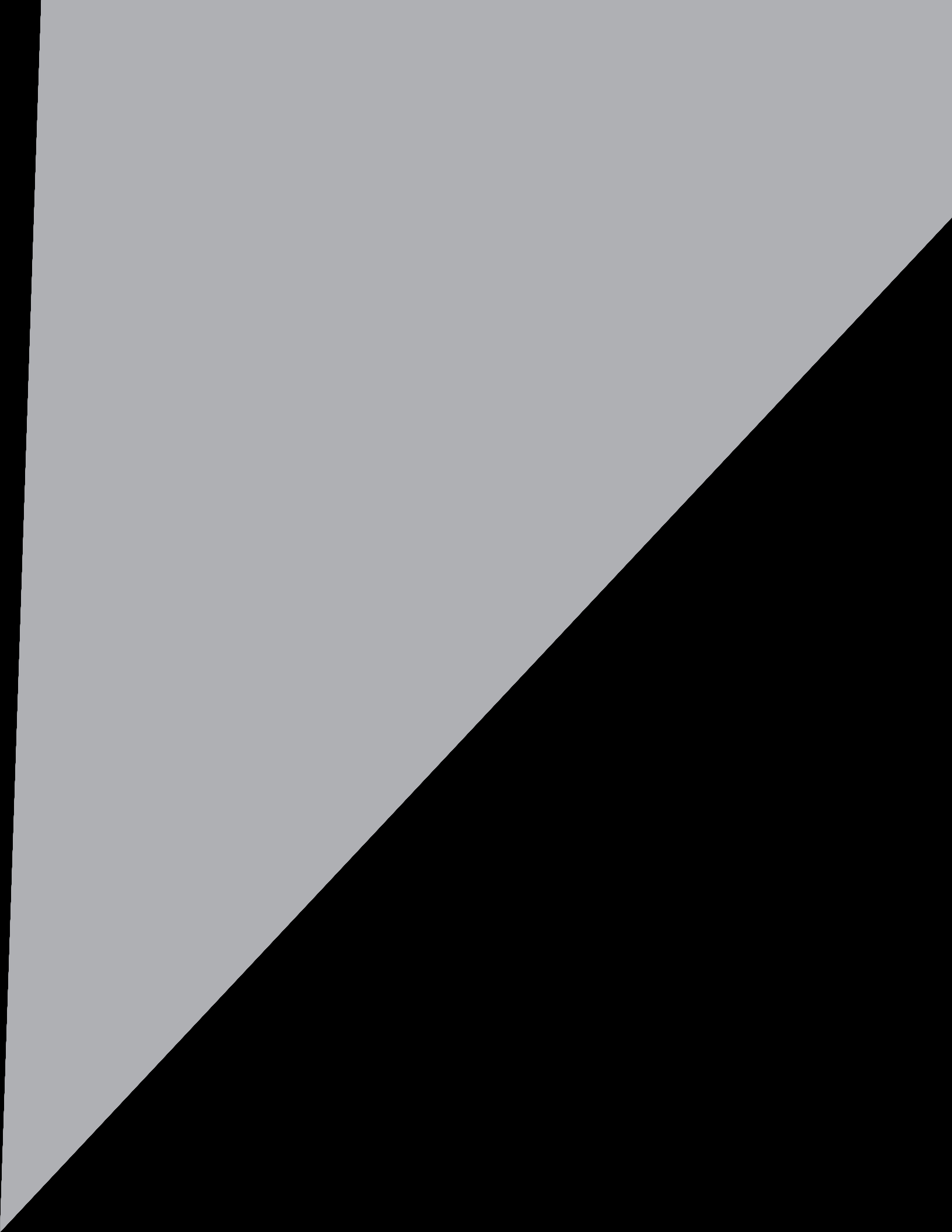

FortiBlade-4010 module

Each FortiBlade-4010 module is an independent FortiGate-4000 antivirus firewall capable of operating at gigabit network speeds. You can install up to 10 FortiBlade-4010 modules in the FortiGate-4000 chassis. Each FortiBlade-4010 module can operate as a standalone FortiGate-4000 antivirus firewall or you can group FortiBlade-4010 modules into high availability (HA) clusters. Each cluster provides failover between the FortiBlade-4010 modules in the cluster. In addition, when operating in active-active HA mode, the FortiBlade-4010 clusters provide antivirus scanning load balancing to increase virus scanning performance.

Figure 4: FortiBlade-4010 front panel

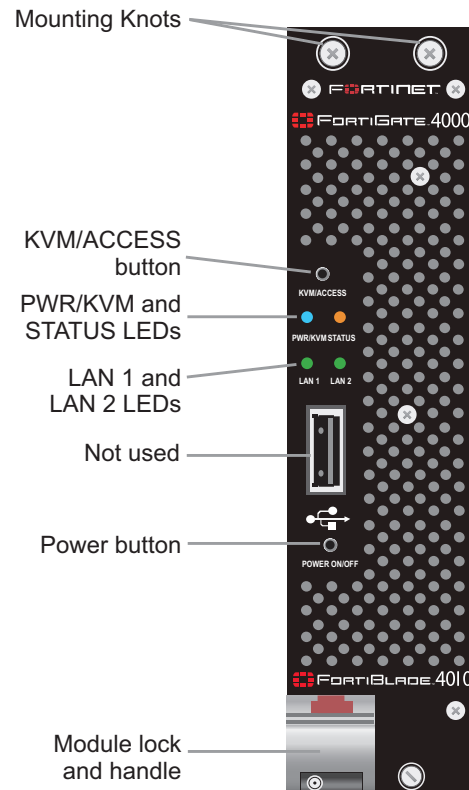

Table 2: FortiBlade-4010 module front panel buttons

Button	Description
KVM/Access	Press and hold for approximately 5 seconds for KVM access to a FortiBlade-4010 module.
Power	Power the FortiBlade-4010 module on or off.

Table 3: FortiBlade-4010 module front panel LEDs

LED	State	Description
PWR/KVM	Blue	The FortiBlade-4010 module is powered on.
	Green	KVM access to this FortiBlade-4010 module is enabled.
STATUS	Off	Normal operation.
	Red	System Fault.
LAN 1	Green	The correct cable is connected to the internal interface of this FortiBlade-4010 module and the connected equipment has power.
	Flashing	Network activity at the internal interface of this FortiBlade-4010 module.
LAN 2	Green	The correct cable is connected to the external interface of this FortiBlade-4010 module and the connected equipment has power.
	Flashing	Network activity at the external interface of this FortiBlade-4010 module.

KVM switch module

Use the KVM switch module to switch serial connections to the CLI of each FortiBlade-4010 module installed in the FortiGate-4000 chassis. To access the CLI, connect the the black header of the RJ-45 to DB-9 serial cable to the management module (see [“Management module” on page 33](#)) and to a management PC. You can use the FortiBlade select buttons on the KVM switch module to select the FortiBlade-4010 module that you can connect to.

Figure 5: KVM switch module front panel

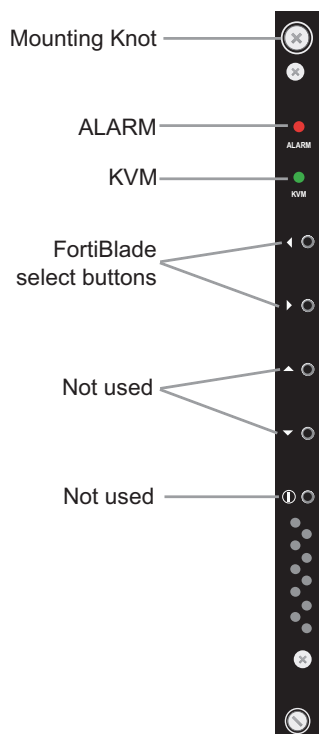

Cooling fan trays

The FortiGate-4000 chassis is cooled using four hot swappable cooling fan trays. Each tray includes one 10-cm ball bearing fan unit.

[Figure 9](#) illustrates a cooling fan tray.

Figure 9: Cooling fan tray



Management module

Use the KVM switch module to switch serial connections to the CLI of each FortiBlade-4010 module installed in the FortiGate-4000 chassis. To access the CLI, connect the black header of the RJ-45 to DB-9 serial cable to the management module and to a management PC. You can use the FortiBlade select buttons on the KVM switch module (see [“KVM switch module” on page 30](#)) to select the FortiBlade-4010 module that you can connect to.

Figure 10: Management module

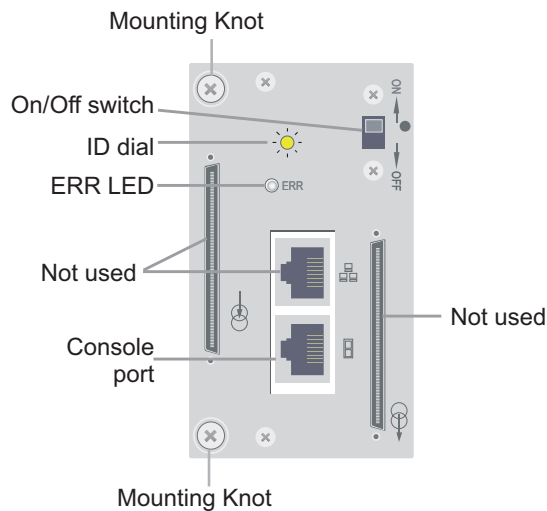

Table 6: Management module controls

Button	Description
On/Off switch	Turns the management module on and off. The management module must be turned on to establish a serial connection to the CLI of each FortiBlade-4010 module.
ID dial	Set to 0.
Console port	Serial connection to the CLI of each FortiBlade-4010 module.

Table 7: KVM switch module LED

LED	State	Description
ERR	Off	Normal operation.
	Yellow	System fault. Contact Fortinet Technical Support.

10/100 out of band management module

The 10/100 out of band management module provides dedicated ethernet connection to manage each FortiBlade-4010 module installed in the FortiGate-4000 chassis. This out of band connection is not shared by other network connections. The 10/100 out of band management module contains two 10/100 ethernet interfaces that connect to the management interface of each FortiBlade-4010 module.



Note: You can connect to the LAN 1 connector or to the LAN 2 connector but not both.

Figure 11: 10/100 out of band management module**Table 8: 10/100 out of band management module LEDs**

LED	State	Description
Interface LEDs	Amber	The correct cable is in use and the connected equipment has power.
	Flashing Amber	Network activity at this interface.
	Green	The interface is connected at 100 Mbps.

The internal switched interface module provides two gigabit connections to the internal interfaces of the FortiBlade-4010 modules installed in the FortiGate-4000 chassis. The external switched interface module provides two gigabit connections to the external interfaces of the FortiBlade-4010 modules installed in the FortiGate-4000 chassis. The switched interface modules act as layer 2 switches.

Figure 13: Switched interface module



Table 10: Switched interface connectors

Connector	Description
LAN1 and LAN2	10/100/1000 Mbit copper interfaces.
SFP	Small form-factor pluggable (SFP) interface. You can install optical connectors into these interfaces to connect the FortiGate-4000 unit to your optical network.
ON OFF	Turn the switched interface module on and off.

Table 11: Pass-through interface module LEDs

LED	State	Description
Interface LEDs	Amber	The correct cable is in use and the connected equipment has power.
	Flashing Amber	Network activity at this interface.
	Green	The interface is connected at up to 1000 Mbps.
Status	Green	System fault. Contact Fortinet technical support.

Installing hardware

This section describes how to install FortiGate-4000 hardware.

- [Choosing a suitable environment](#)
- [Choosing a rack](#)
- [Attaching the mounting rail](#)
- [Installing FortiBlade-4010 modules](#)
- [FortiGate-4000P network connections](#)
- [FortiGate-4000S network connections](#)
- [Out of band management connections](#)
- [Console management connections](#)

Choosing a suitable environment

Considering the following factors when selecting a suitable location for the FortiGate-4000 unit:

- Install the FortiGate-4000 chassis on a flat, stable surface or in a suitable rack.
- Avoid a location that is exposed to strong vibration.
- Install the FortiGate-4000 chassis away from electromagnetic or radio frequency interference.
- Avoid using or storing the FortiGate-4000 chassis where it can be exposed to extreme temperatures. Do not leave the server in direct sunlight or near a heat source for a long period. High temperature can damage the circuitry.
- Avoid exposing the FortiGate-4000 chassis to high or low humidity.

Choosing a rack

Install the FortiGate-4000 chassis in a rack or cabinet with a depth of more than 700 mm, excluding the front door depth. For better heat dissipation, the rear side of the rack cabinet should be open.

Attaching the mounting rail

You can attach a mounting rail to the FortiGate-4000 chassis so that you can slide the chassis out from the rack for maintenance. There are 11 mounting holes on the FortiGate-4000 chassis that match different manufacturer mounting rails. [Figure 14](#) shows the mounting locations to install the FortiGate-4000 mounting rail. Use the three screws included with the FortiGate-4000 mounting rail kit.

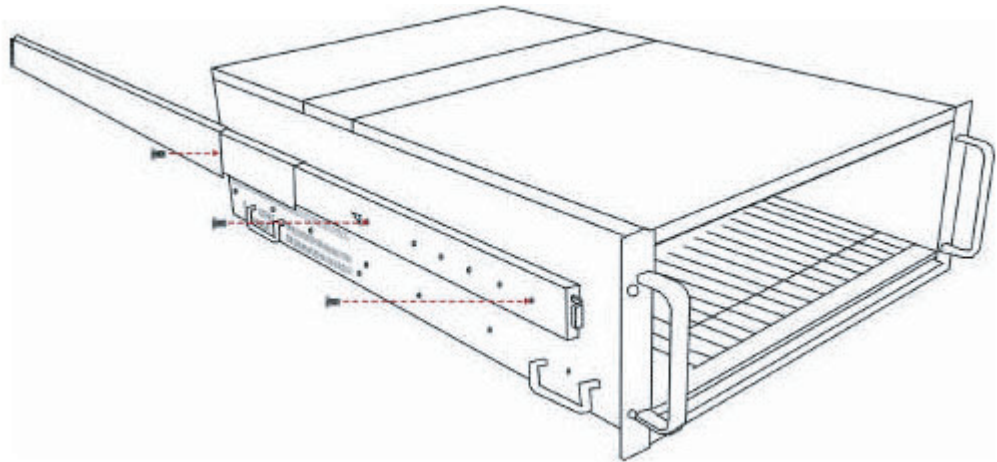
Figure 14: Rail mounting locations

Installing FortiBlade-4010 modules

Install a FortiBlade-4010 module by removing a FortiGate-4000 unit slot cover and replacing it with a FortiBlade-4010 module. Begin installing the FortiBlade-4010 modules at slot number 1 and fill the FortiGate-4000 chassis from left to right (see [Figure 3 on page 28](#) for slot numbering).



Note: Do not operate the FortiGate-4000 unit with open slots on the front panel. For optimum cooling performance, all front panel slots should either contain a FortiBlade-4010 module or be covered by an empty slot cover.

- 1 Loosen the two screws both at the top and bottom of the FortiGate-4000 unit's empty slot cover that fastens the cover to the FortiGate-4000 chassis.
- 2 Remove the cover from the chassis.
- 3 Holding the FortiBlade-4010 module by the module lock and handle, insert the FortiBlade-4010 module into the chassis. See [Figure 15](#).

Figure 15: Inserting the FortiBlade-4010 module into the chassis

- 4 Slide the FortiBlade-4010 module into the slot until the lock clicks into place.
- 5 Tighten the mounting knots both at the top and bottom of the front panel of the FortiBlade-4010 module.

FortiGate-4000P network connections

Use the following steps to connect your internal and external networks to the FortiGate-4000P pass-through interface modules that support 1000Base-T connections. This is a general connection procedure only. For information about how to connect the FortiGate-4000 unit for different network configurations, see [“Planning the FortiGate configuration” on page 53](#).

- 1** Connect your internal network to the internal pass-through interface module.
The internal pass-through interface module is installed on the right rear panel of the FortiGate-4000P (see [Figure 6 on page 31](#)).
You will need one network connection for each FortiBlade-4010 module installed in the FortiGate-4000 chassis. Each FortiBlade-4010 module is connected to a different interface on the pass-through interface module. See [Figure 12 on page 35](#) for the correspondence between the slots on the FortiGate-4000 chassis and the interfaces on the pass-through interface module.
- 2** Connect your external network to the external pass-through interface module.
The external pass-through interface module is installed on the left rear panel of the FortiGate-4000P (see [Figure 6 on page 31](#)).
You will need one network connection for each FortiBlade-4010 module installed in the FortiGate-4000 chassis. Each FortiBlade-4010 module is connected to a different interface on the pass-through interface module. See [Figure 12 on page 35](#) for the correspondence between the slots on the FortiGate-4000 chassis and the interfaces on the pass-through interface module.

FortiGate-4000S network connections

Use the following steps to connect your internal and external networks to the FortiGate-4000S switched interface modules that support 10/100/1000Base-T connections. This is a general connection procedure only. For information about how to connect the FortiGate-4000 unit for different network configurations, see [“Planning the FortiGate configuration” on page 53](#).

- 1** Connect your internal network to the internal switched interface module.
The internal switched interface module is installed on the right rear panel of the FortiGate-4000S (see [Figure 7 on page 32](#)).
You can connect to the copper gigabit ethernet interfaces or to optical connectors installed in the SFP interfaces. See [Figure 13 on page 36](#) for the location of the copper gigabit and SFP connectors.
- 2** Connect your external network to the external switched interface module.
The external switched interface module is installed on the left rear panel of the FortiGate-4000S chassis (see [Figure 7 on page 32](#)).

Out of band management connections

You can manage the FortiBlade-4010 modules by connecting to the 10/100 out of band management module. The 10/100 out of band management module provides ethernet management connections for all of the FortiBlade-4010 modules installed in the FortiGate-4000 chassis. See [Figure 6 on page 31](#) or [Figure 7 on page 32](#) for the location of the 10/100 out of band management module.



Note: All FortiBlade-4010 modules are shipped with the same default IP address (172.16.1.2). You need to change the IP address before trying to manage the modules.

Console management connections

You can connect to the CLI of each FortiBlade-4010 module by connecting the RJ-45 to DB-9 serial cable to the management module console port (see [Figure 10 on page 33](#)). The management module provides console connections for all of the FortiBlade-4010 modules installed in the FortiGate-4000 chassis.

Use the KVM switch module to switch serial connections to the CLI of each FortiBlade-4010 module installed in the FortiGate-4000 chassis. To access the CLI, connect the black header of the RJ-45 to DB-9 serial cable to the management module (see [“Management module” on page 33](#)) and to a management PC. You can use the KVM switch module (see [“KVM switch module” on page 30](#)) to select the FortiBlade-4010 module that you can connect to.

Turning FortiGate-4000 chassis power on and off

Use the following procedures when turning on and off power to the FortiGate-4000 chassis. Turn power on and power off in the order specified in the following procedures to avoid damaging FortiGate-4000 chassis components.

- [Turning on FortiGate-4000 chassis power](#)
- [Turning off FortiGate-4000 chassis power](#)

The FortiGate-4000 chassis automatically recovers from a power outage. When the power restores, the FortiGate-4000 chassis takes a few seconds to power on. A few seconds after the chassis is on, the FortiBlade-4010 modules power on automatically.

Turning on FortiGate-4000 chassis power

Turning on the FortiGate-4000 chassis power consists of making power connections, turning on power supplies, and then turning on individual components.

- 1 Make sure all FortiGate-4000 chassis power switches are turned off. Check the following:
 - Power switch on each power supply module
 - Chassis power switch on the power connector module
 - On/off switch on the management module
 - On/off switch on the switched interface module (FortiGate-4000S)

- 2 Connect the three power cables to the power connection module on the FortiGate-4000 chassis back panel.
- 3 Connect the power cables to power outlets.
- 4 Turn on the power switch on each power supply module.
- 5 Press and hold the chassis power switch for a few seconds to turn it on to supply power to the power supplies.
The Power LED on each power supply module lights.
- 6 Turn on the management module power switch.
- 7 Turn on the switched interface module power switch for each switched interface module (FortiGate-4000S).
- 8 Press and hold the power button on each FortiBlade-4010 module for a few seconds.
The PWR LED on each FortiBlade-4010 module lights.

Turning off FortiGate-4000 chassis power

Turning off the FortiGate-4000 chassis power in the reverse order from turning power on.



Note: Always wait at least five seconds after turning off FortiGate-4000 chassis power before turning it back on. Turning the power on and off in rapid succession can damage FortiGate-4000 electrical circuitry.

- 1 Press the power button on each FortiBlade-4010 module.
The PWR LED on each FortiBlade-4010 module goes out.
- 2 Turn off the switched interface module power switch for each switched interface module (FortiGate-4000S).
- 3 Turn off the management module power switch.
- 4 Turn off the chassis power switch.
- 5 Turn off the power switch on each power supply module.

Hot swapping modules

This section describes how to hot swap the modules installed in the FortiGate-4000 chassis. Hot swapping refers to removing a failed module and replacing it with a new version of the same module while the FortiGate-4000 chassis remains in operation.

This section describes:

- [Hot swapping FortiBlade-4010 modules](#)
- [Hot swapping cooling fan trays](#)
- [Hot swapping power supplies](#)
- [Hot swapping interface modules](#)
- [Hot swapping the 10/100 out of band management module](#)
- [Hot swapping the management module](#)
- [Hot swapping the KVM switch module](#)

Hot swapping FortiBlade-4010 modules

Follow this procedure to hot swap the FortiBlade-4010 modules. For information about the FortiBlade-4010 module, see [“FortiBlade-4010 module” on page 29](#).

- 1 Press the power button on the front panel of the FortiBlade-4010 module that you want to replace.

The PWR LED on the FortiBlade-4010 module goes out.



Note: Wait at least five seconds after turning off the power before removing the FortiBlade-4010 module from the chassis.

- 2 Loosen the two mounting knots that fasten the module system tray to the FortiGate-4000 chassis. Do not remove the mounting knots.
- 3 Holding the FortiBlade-4010 module by the module lock and handle, slide it out of the chassis.
- 4 Holding the new FortiBlade-4010 module by the module lock and handle, insert it into the chassis.
- 5 Slide the FortiBlade-4010 module into the slot until the lock clicks into place.
- 6 Tighten the mounting knots on the top of the front panel of the FortiBlade-4010 module.
- 7 Press the power button on the FortiBlade-4010 module.
The PWR LED on the FortiBlade-4010 module lights.

Hot swapping cooling fan trays

Each FortiGate-4000 unit has four cooling fan trays. See [“Cooling fan trays” on page 33](#) for more information.

Follow this procedure to hot swap a cooling fan tray.

- 1 From the rear panel of the FortiGate-4000 chassis, pull out the cooling fan tray you want to replace by the handle.
- 2 Holding the new fan tray by the handle, insert it into the chassis.

Hot swapping power supplies

The FortiGate-4000 power supply modules are secured to the chassis by a locking handle and a locking strip located at the bottom of the modules. For more information, see [“Rear panel features” on page 31](#).

Follow this procedure to hot swap a power supply module.

- 1 On the power supply module that you want to replace, turn off the power supply.
- 2 From the rear panel of the FortiGate-4000 chassis, unscrew the two locking screws that fasten the locking strip of the power supply modules. See [Figure 8 on page 32](#).
- 3 Remove the locking strip.
- 4 Lift up the locking handle of the power supply to be removed.
- 5 Pull out the power supply module by the handle.
- 6 Holding the new power supply module by the handle, insert it into the chassis.

- 7 Slide the power supply module into the slot until the lock clicks into place.
- 8 Turn on the power supply.
- 9 Replace the locking strip.
- 10 Quickly toggle the chassis power supply switch to turn on the power supply module.



Note: If you press the chassis power supply switch for more than four seconds, the entire FortiGate-4000 unit turns off.

Hot swapping interface modules

This procedure describes how to hot swap a pass-through interface module or a switched interface module.

For more information on these modules, see [“Pass-through interface module” on page 35](#) and [“Switched interface module” on page 35](#) respectively.

- 1 From the rear panel of the FortiGate-4000 chassis, loosen the two mounting knots that fasten the pass-through interface module or the switched interface module that you want to replace. Do not remove the mounting knots.
- 2 Do one of the following:
 - For the pass-through interface module, pull it out.
 - For the switched interface module, turn its power off and then pull it out.
- 3 Do one of the following:
 - Insert the new pass-through interface module into the chassis.
 - Insert the new switched interface module into the chassis, and turn on its power.
- 4 Tighten the mounting knots on the pass-through interface module or the switched interface module.

Hot swapping the 10/100 out of band management module

Follow this procedure to hot swap a 10/100 out of band management module on the rear panel of the FortiGate-4000 chassis.

For more information, see [“10/100 out of band management module” on page 34](#).

- 1 From the rear panel of the FortiGate-4000 chassis, loosen the two mounting knots that fasten the 10/100 out of band management that you want to replace. Do not remove the mounting knots.
- 2 Pull the module out.
- 3 Insert the new switched interface module into the chassis.
- 4 Tighten the mounting knots on the module.

Hot swapping the management module

Follow this procedure to hot swap a management module on the rear panel of the FortiGate-4000 chassis.

For more information on these modules, see [“Management module” on page 33](#).

- 1 Power off the management module that you want to replace.

- 2 Unscrew the two locking screws to remove the module's locking strip.
- 3 Loosen its two mounting knots. Do not remove the mounting knots.
- 4 Pull out the management module.
- 5 Insert the new management module into the chassis.
- 6 Slide the management module into the slot until the lock clicks into place.
- 7 Screw the locking screws to fasten the locking strip.
- 8 Tighten the two mounting knots.
- 9 Turn on the power of the management module.

Hot swapping the KVM switch module

Follow this procedure to hot swap a KVM switch module.

For more information on the KVM switch module, see ["KVM switch module" on page 30](#).

- 1 From the front panel of the FortiGate-4000 chassis, loosen the two mounting knots that fasten the KVM switch module that you want to replace.
- 2 Pull out the KVM switch module.
- 3 Insert the new KVM switch module into the chassis.
- 4 Tighten the two mounting knots to fasten the KVM switch module to the chassis.

Connecting to the web-based manager

You can connect to the FortiGate-4000 web-based manager of each FortiGate-4000 unit installed in the FortiGate-4000 chassis by connecting to FortiGate-4000 internal interface module or by connecting to the FortiGate-4000 10/100 out of band management module.



Note: Each FortiBlade-4010 module is a FortiGate-4000 antivirus firewall.

To connect to the web-based manager you need:

- an ethernet connection between a management computer and the FortiGate-4000 unit.
- Internet Explorer version 4.0 or higher running on the management computer.



Note: You can use the web-based manager with recent versions of most popular web browsers. The web-based manager is fully supported for Internet Explorer version 4.0 or higher.

- [Connecting to the FortiGate-4000 internal interface module](#)
- [Connecting to the FortiGate-4000 10/100 out of band management module](#)
- [Connecting to the Command Line Interface \(CLI\)](#)

Connecting to the FortiGate-4000 internal interface module

To connect to the web-based manager of a FortiGate-4000 unit using the FortiGate-4000 internal interface module, you must connect the FortiGate-4000 internal interface module to the same network as your management computer.

To connect to the web-based manager

- 1 Connect the internal interface module to your network.
 - For the FortiGate-4000P, each FortiGate-4000 unit is connected to a different connector on the internal interface pass-through interface module. See [Figure 6 on page 31](#) for the location of the internal interface pass-through module. See [Figure 12 on page 35](#) for the correspondence between each pass-through interface connector and each FortiGate-4000 unit .
 - For the location of the FortiGate-4000 unit internal interface connections for the FortiGate-4000S, see [Figure 7 on page 32](#).

- 2 Power on the FortiGate-4000 unit that you want to connect to.



Note: When first installed, all FortiGate-4000 units installed in the FortiGate-4000 chassis have the same internal, external, and out of band management IP addresses. To connect to a specific FortiGate-4000 unit, you must turn on the power for this FortiGate-4000 unit. The power to all of the other FortiGate-4000 units must be turned off.

Alternatively, you can use the CLI to change the default internal IP address of a specific FortiGate-4000 unit to which you want to connect. This way, you do not need to power off all of the other FortiGate-4000 units when connecting to that specific FortiGate-4000 unit.

- 3 Set the IP address of the management computer with an ethernet connection to the static IP address 192.168.1.2 and a netmask of 255.255.255.0.
- 4 Start Internet Explorer and browse to the address <https://192.168.1.99> (remember to include the “s” in https://).
The FortiGate login is displayed.
- 5 Type `admin` in the Name field and select Login.

The Register Now window is displayed. Use the information in this window to register your FortiGate unit so that Fortinet can contact you for firmware updates. You must also register to receive updates to the FortiGate virus and attack definitions.

Figure 16: FortiGate login



Connecting to the FortiGate-4000 10/100 out of band management module

To connect to the web-based manager of a FortiGate-4000 unit using the FortiGate-4000 10/100 out of band management module, you must connect the out of band management module to the same network as your management computer.

For more information about the 10/100 out of band management module, see [“10/100 out of band management module”](#) on page 34 and [“Out of band management connections”](#) on page 40.

To connect to the 10/100 out of band management module

- 1 Connect the 10/100 out of band management module to your network.
- 2 Power on the FortiGate-4000 unit that you want to connect to.



Note: When first installed, all FortiGate-4000 units installed in the FortiGate-4000 chassis have the same internal, external, and out of band management IP addresses. To connect to a specific FortiGate-4000 unit, you must turn on the power for this FortiGate-4000 unit. The power to all of the other FortiGate-4000 units must be turned off.

- 3 Set the IP address of the computer with an ethernet connection to the static IP address 172.16.1.3 and a netmask of 255.255.255.0.
- 4 Start Internet Explorer and browse to the address <https://172.16.1.2> (remember to include the “s” in https://).
The FortiGate login is displayed.
- 5 Type `admin` in the Name field and select Login.

The Register Now window is displayed. Use the information in this window to register your FortiGate unit so that Fortinet can contact you for firmware updates. You must also register to receive updates to the FortiGate virus and attack definitions.

To change the out of band management IP address

- 1 After logging into the FortiGate-4000 unit, go to **System > Network > OOB Management**.
- 2 Change the IP/Netmask addresses.
- 3 Select Apply to save the changes.

Connecting to the Command Line Interface (CLI)

Connect to the CLI of each FortiGate-4000 unit by connecting to the management interface module. Use the KVM switch module to switch serial connections to the CLI of each FortiGate-4000 unit installed in the FortiGate-4000 chassis. See [Figure 5 on page 30](#) for the description of the KVM switch module.

To connect to the CLI of each FortiGate-4000 unit , you need:

- a computer with an available communications port,
- a RJ-45 to DB-9 cable included in your FortiGate package,
- terminal emulation software such as HyperTerminal for Windows.



Note: The following procedure describes how to connect to the CLI using Windows HyperTerminal software. You can use any terminal emulation program.

To connect to the CLI of each FortiGate-4000 unit

- 1 Connect the black header of the RJ-45 to DB-9 cable to the communications port of your computer and to the management module console port.
- 2 Make sure that the FortiGate-4000 unit is powered on.
- 3 Use the KVM select buttons on the KVM switch module to select the FortiGate-4000 unit that you want to connect to.
- 4 On the front panel of the FortiGate-4000 unit you select, press and hold the KVM/Access button for approximately 5 seconds for CLI access to the module. The PWR/KVM LED turns green, and CLI access to the module is enabled.
- 5 Start HyperTerminal on your management computer, enter a name for the connection, and select OK.
- 6 Configure HyperTerminal to connect directly to the communications port on the computer to which you have connected the RJ-45 to DB-9 cable and select OK.
- 7 Select the following port settings and select OK.

Bits per second	9600
Data bits	8
Parity	None
Stop bits	1
Flow control	None

- 8 Press Enter to connect to the CLI of the FortiGate-4000 unit.
The following prompt is displayed:
FortiGate-4000 login:
- 9 Type `admin` and press Enter twice.
The following prompt is displayed:
Type ? for a list of commands.
For information about how to use the CLI, see the *FortiGate CLI Reference Guide*.

Factory default configuration

Each FortiGate-4000 unit in a FortiGate-4000 chassis is shipped with a factory default configuration. The default configuration allows you to connect to and use the FortiGate web-based manager to configure the FortiGate-4000 unit onto the network. To configure the FortiGate-4000 unit onto the network, you add an administrator password, change network interface IP addresses, add DNS server IP addresses, and configure routing, if required.

If you plan to operate the FortiGate-4000 unit in Transparent mode, you can switch to Transparent mode from the factory default configuration and then configure the FortiGate-4000 unit onto the network in Transparent mode.

Once the network configuration is complete, you can perform additional configuration tasks such as setting system time, configuring virus and attack definition updates, and registering the FortiGate-4000 unit.

The factory default firewall configuration includes a single network address translation (NAT) policy that allows users on your internal network to connect to the external network, and stops users on the external network from connecting to the internal network. You can add more policies to provide more control of the network traffic passing through the FortiGate-4000 units.

The factory default content profiles can be used to apply different levels of antivirus protection, web content filtering, and email filtering to the network traffic that is controlled by firewall policies.

- [Factory default NAT/Route mode network configuration](#)
- [Factory default Transparent mode network configuration](#)
- [Factory default firewall configuration](#)
- [Factory default content profiles](#)

Factory default NAT/Route mode network configuration

When the FortiGate-4000 unit is first powered on, it is running in NAT/Route mode and has the basic network configuration listed in [Table 12](#). This configuration allows you to connect to the FortiGate-4000 unit web-based manager and establish the configuration required to connect the FortiGate-4000 unit to the network. In [Table 12](#), HTTPS management access means you can connect to the web-based manager using this interface. Ping management access means this interface responds to ping requests.

Table 14: Factory default firewall configuration

Internal Address	Internal_All	IP: 0.0.0.0	Represents all of the IP addresses on the internal network.
		Mask: 0.0.0.0	
External Address	External_All	IP: 0.0.0.0	Represents all of the IP addresses on the external network.
		Mask: 0.0.0.0	
Recurring Schedule	Always		The schedule is valid at all times. This means that the firewall policy is valid at all times.
Firewall Policy	Internal->External		Firewall policy for connections from the internal network to the external network.
	Source	Internal_All	The policy source address. Internal_All means that the policy accepts connections from any internal IP address.
	Destination	External_All	The policy destination address. External_All means that the policy accepts connections with a destination address to any IP address on the external network.
	Schedule	Always	The policy schedule. Always means that the policy is valid at any time.
	Service	ANY	The policy service. ANY means that this policy processes connections for all services.
	Action	ACCEPT	The policy action. ACCEPT means that the policy allows connections.
	<input checked="" type="checkbox"/> NAT		NAT is selected for the NAT/Route mode default policy so that the policy applies network address translation to the traffic processed by the policy. NAT is not available for Transparent mode policies.
	<input type="checkbox"/> Traffic Shaping		Traffic shaping is not selected. The policy does not apply traffic shaping to the traffic controlled by the policy. You can select this option to control the maximum or minimum amount of bandwidth available to traffic processed by the policy.
	<input type="checkbox"/> Authentication		Authentication is not selected. Users do not have to authenticate with the firewall before connecting to their destination address. You can configure user groups and select this option to require users to authenticate with the firewall before they can connect through the firewall.
	<input checked="" type="checkbox"/> Antivirus & Web Filter		Antivirus & Web Filter is selected.
	Content Profile	Scan	The scan content profile is selected. The policy scans all HTTP, FTP, SMTP, POP3, and IMAP traffic for viruses. See “Scan content profile” on page 51 for more information about the scan content profile. You can select one of the other content profiles to apply different levels of content protection to traffic processed by this policy.
<input type="checkbox"/> Log Traffic		Log Traffic is not selected. This policy does not record messages to the traffic log for the traffic processed by this policy. You can configure FortiGate logging and select Log Traffic to record all connections through the firewall that are accepted by this policy.	

Factory default content profiles

You can use content profiles to apply different protection settings for content traffic that is controlled by firewall policies. You can use content profiles for:

- Antivirus protection of HTTP, FTP, IMAP, POP3, and SMTP network traffic
- Web content filtering for HTTP network traffic
- Email filtering for IMAP and POP3 network traffic
- Oversized file and email blocking for HTTP, FTP, POP3, SMTP, and IMAP network traffic
- Passing fragmented emails in IMAP, POP3, and SMTP email traffic

Using content profiles, you can build protection configurations that can be applied to different types of firewall policies. This allows you to customize types and levels of protection for different firewall policies.

For example, while traffic between internal and external addresses might need strict protection, traffic between trusted internal addresses might need moderate protection. You can configure policies for different traffic services to use the same or different content profiles.

Content profiles can be added to NAT/Route mode and Transparent mode policies.

Strict content profile

Use the strict content profile to apply maximum content protection to HTTP, FTP, IMAP, POP3, and SMTP content traffic. You do not need to use the strict content profile under normal circumstances, but it is available if you have extreme problems with viruses and require maximum content screening protection.

Table 15: Strict content profile

Options	HTTP	FTP	IMAP	POP3	SMTP
Antivirus Scan	<input checked="" type="checkbox"/>	<input checked="" type="checkbox"/>	<input checked="" type="checkbox"/>	<input checked="" type="checkbox"/>	<input checked="" type="checkbox"/>
File Block	<input checked="" type="checkbox"/>	<input checked="" type="checkbox"/>	<input checked="" type="checkbox"/>	<input checked="" type="checkbox"/>	<input checked="" type="checkbox"/>
Web URL Block	<input checked="" type="checkbox"/>				
Web Content Block	<input checked="" type="checkbox"/>				
Web Script Filter	<input checked="" type="checkbox"/>				
Web Exempt List	<input checked="" type="checkbox"/>				
Email Block List			<input checked="" type="checkbox"/>	<input checked="" type="checkbox"/>	
Email Exempt List			<input checked="" type="checkbox"/>	<input checked="" type="checkbox"/>	
Email Content Block			<input checked="" type="checkbox"/>	<input checked="" type="checkbox"/>	
Oversized File/Email Block	block	block	block	block	block
Pass Fragmented Emails			<input type="checkbox"/>	<input type="checkbox"/>	<input type="checkbox"/>

Scan content profile

Use the scan content profile to apply antivirus scanning to HTTP, FTP, IMAP, POP3, and SMTP content traffic.

Table 16: Scan content profile**Web content profile**

Use the web content profile to apply antivirus scanning and web content blocking to HTTP content traffic. You can add this content profile to firewall policies that control HTTP traffic.

Unfiltered content profile

Use the unfiltered content profile if you do not want to apply content protection to traffic. You can add this content profile to firewall policies for connections between highly trusted or highly secure networks where content does not need to be protected.

Planning the FortiGate configuration

Before you configure the FortiGate-4000 units in the FortiGate-4000 chassis, you need to plan how to integrate them into your network. Among other things, you must decide whether you want the FortiGate-4000 units to be visible to the network, which firewall functions you want to provide, and how you want it to control the traffic flowing between FortiGate-4000 unit interfaces.

This section contains overviews for installing a FortiGate-4000 unit with the following configurations:

- [NAT/Route mode standalone configuration](#)
- [Transparent mode standalone configuration](#)
- [FortiGate-4000 HA configuration](#)
- [FortiGate-4000P units with external load balancers](#)

NAT/Route mode standalone configuration

0723i64 -1.2048 TD0.2027 Tc=0.0024 Twa(ig)4n3(r)-1tivi1(ur)3u3(r)-1s fi1(ur)3e3(r)-1wall. Eawhio

For each FortiGate-4000 unit, the following interfaces are available for processing network traffic in NAT/Route mode:

- External: the interface to the external network (usually the Internet).
- Internal: the interface to the internal network.

In addition, the 10/100 out of band management interface is available for out of band management. The out of band management IP address must not be on the same subnet as the internal or external interfaces.

You can add security policies to control whether communications through the FortiGate-4000 unit operate in NAT or Route mode. Security policies control the flow of traffic based on the source address, destination address, and service of each packet. In NAT mode, the FortiGate-4000 unit performs network address translation before it sends the packet to the destination network. In Route mode, there is no translation.

By default, the FortiGate-4000 unit has a NAT mode security policy that allows users on the internal network to securely download content from the external network. No other traffic is possible until you have configured further security policies.

You typically use NAT/Route mode when the FortiGate-4000 unit is operating as a gateway between private and public networks. In this configuration, you would create NAT mode policies to control traffic flowing between the internal, private network and the external, public network (usually the Internet).

Figure 17: Example NAT/Route mode standalone network configuration



Transparent mode standalone configuration

In Transparent mode standalone configuration, each FortiGate-4000 unit in the FortiGate-4000 chassis operates as a separate Transparent mode FortiGate-4000 antivirus firewall. Each of these FortiGate-4000 unit is invisible to the network. Similar to a network bridge, the FortiGate internal and external interfaces must be on the same subnet. You only have to configure a management IP address so that you can make configuration changes. The management IP address is also used for antivirus and attack definition updates.

In addition, the 10/100 out of band management interface is available for out of band management. The out of band management IP address must not be on the same subnet as the management IP address.

You typically use a FortiGate-4000 unit in Transparent mode on a private network behind an existing firewall or behind a router. The FortiGate-4000 unit performs firewall functions as well as antivirus and content scanning but not VPN.

The following interfaces are available in Transparent mode:

- External: the interface to the external network (usually the Internet).
- Internal: the interface to the internal network.

Figure 18: Example Transparent mode standalone network configuration

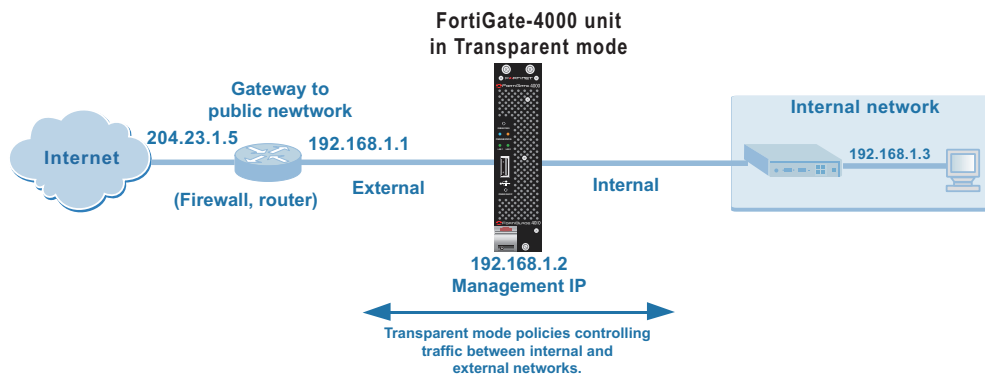

FortiGate-4000 HA configuration

Using HA, you can group two or more FortiGate-4000 units into an HA cluster. The HA cluster can operate in active-active mode or active-passive mode.

An active-active HA cluster can increase virus scanning throughput by using load balancing to distribute virus scanning to all of the FortiGate units in the cluster.

An active-passive HA cluster provides failover so that if a functioning FortiGate-4000 unit fails, processing is transferred to another FortiGate-4000 unit in the cluster without interrupting network service.

Once the FortiGate-4000 units are added to the HA cluster, the cluster functions on your network as a single FortiGate-4000 unit with one internal interface, one external interface, and one out of band management IP address. The cluster manages communication and load balancing between the FortiGate-4000 units in the cluster.

Because you can install up to 10 FortiGate-4000 units in a single FortiGate-4000 chassis, you can configure multiple HA clusters. Each FortiGate-4000 unit can only belong to one cluster.

You can operate an HA cluster in NAT/Route or Transparent mode. A single FortiGate-4000 chassis can contain clusters operating in NAT/Route mode and clusters operating in Transparent mode. For more information on HA, see [“High availability” on page 81](#).

Figure 21: FortiGate-4000P HA configuration

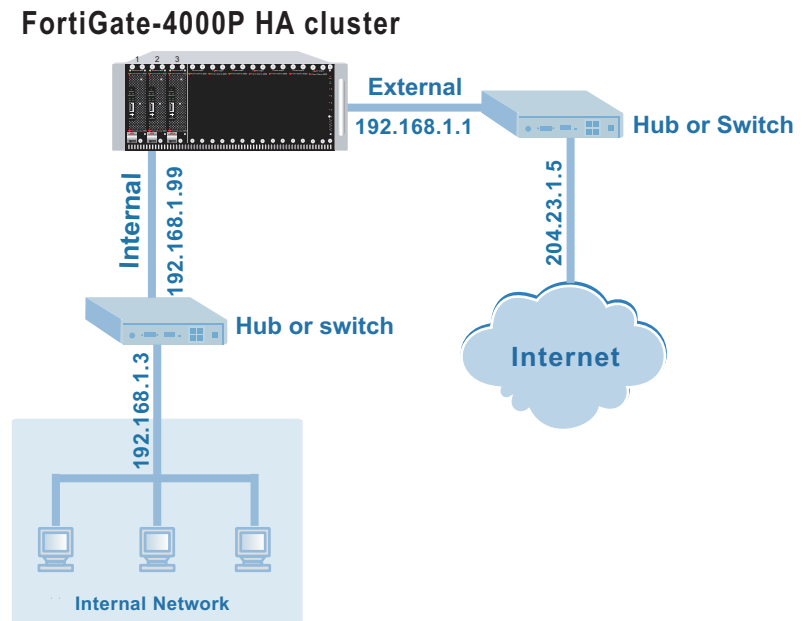

FortiGate-4000S HA configuration

In the FortiGate-4000S HA configuration, all you need to do is to connect your internal network to the internal switched interface module and your external network to the external switched interface module. You do not need to connect to external switches because the switched interface module acts as the switch.

FortiGate-4000P units with external load balancers

The FortiGate-4000P unit can use external load balancers to load balance the virus scanning among all the FortiGate-4000P units in the cluster. Load balancers increase the network's overall security performance by distributing traffic across multiple FortiGate units.

Each FortiGate unit connects directly to the load balancers to load balance internal and external traffic.

With external load balancers, all FortiGate-4000P units in the cluster need to be standalone and operate in NAT/Route mode.

FortiGate model maximum values matrix

Table 19: FortiGate maximum values matrix

	FortiGate model											
	50	60	100	200	300	400	500	800	1000	3000	3600	4000
Routes	500	500	500	500	500	500	500	500	500	500	500	500
Policy routing gateways	500	500	500	500	500	500	500	500	500	500	500	500
Administrative users	500	500	500	500	500	500	500	500	500	500	500	500
VLAN subinterfaces	N/A	N/A	N/A	4096*	4096*	4096*	4096*	4096*	4096*	4096*	4096*	4096*
Zones	N/A	N/A	N/A	100	100	100	100	100	200	300	500	500
Virtual domains	N/A	N/A	N/A	16	32	64	64	64	128	512	512	512
DHCP address scopes	32	32	32	32	32	32	32	32	32	32	32	32
DHCP reserved IP/MAC pairs	10	20	30	30	50	50	100	100	200	200	200	200
Firewall policies	200	500	1000	2000	5000	5000	20000	20000	50000	50000	50000	50000
Firewall addresses	500	500	500	500	3000	3000	6000	6000	10000	10000	10000	10000
Firewall address groups	500	500	500	500	500	500	500	500	500	500	500	500
Firewall custom services	500	500	500	500	500	500	500	500	500	500	500	500
Firewall service groups	500	500	500	500	500	500	500	500	500	500	500	500
Firewall recurring schedules	256	256	256	256	256	256	256	256	256	256	256	256
Firewall onetime schedules	256	256	256	256	256	256	256	256	256	256	256	256
Firewall virtual IPs	500	500	500	500	500	500	500	500	500	500	500	500
Firewall IP pools	50	50	50	50	50	50	50	50	50	50	50	50
IP/MAC binding table entries	500	500	500	500	500	500	500	500	500	500	500	500
Firewall content profiles	32	32	32	32	32	32	32	32	32	32	32	32
User names	20	500	1000	1000	1000	1000	1000	1000	1000	1000	1000	1000
Radius servers	6	6	6	6	6	6	6	6	6	6	6	6
LDAP servers	6	6	6	6	6	6	6	6	6	6	6	6
User groups	100	100	100	100	100	100	100	100	100	100	100	100
Total number of user group members	300	300	300	300	300	300	300	300	300	300	300	300

* Includes the number of physical interfaces.

Table 19: FortiGate maximum values matrix

	FortiGate model											
	50	60	100	200	300	400	500	800	1000	3000	3600	4000
IPSec remote gateways (Phase 1)	20	50	80	200	1500	1500	3000	3000	5000	5000	5000	5000
IPSec VPN tunnels (Phase 2)	20	50	80	200	1500	1500	3000	3000	5000	5000	5000	5000
IPSec VPN concentrators	500	500	500	500	500	500	500	500	500	500	500	500
PPTP users	500	500	500	500	500	500	500	500	500	500	500	500
L2TP users	500	500	500	500	500	500	500	500	500	500	500	500
NIDS user-defined signatures	100	100	100	100	100	100	100	100	100	100	100	100
Antivirus file block patterns	56	56	56	56	56	56	56	56	56	56	56	56
Web filter and email filter lists	Limit varies depending on available system memory. Fortinet recommends limiting total size of web and email filter lists to 4 Mbytes or less. If you want to use larger web filter lists, consider using Cerberian web filtering.											
Log setting traffic filter entries	50	50	50	50	50	50	50	50	50	50	50	50

* Includes the number of physical interfaces.

Next steps

Now that your FortiGate unit is operating, you can proceed to configure it to connect to networks:

- If you are going to operate the FortiGate unit in NAT/Route mode, go to [“NAT/Route mode installation” on page 61](#).
- If you are going to operate the FortiGate unit in Transparent mode, go to [“Transparent mode installation” on page 69](#).
- If you are going to operate two or more FortiGate units in HA mode, go to [“High availability” on page 81](#).

NAT/Route mode installation

This chapter describes how to install the FortiGate unit in NAT/Route mode. For information about installing a FortiGate unit in Transparent mode, see [“Transparent mode installation” on page 69](#). For information about installing two or more FortiGate units in HA mode, see [“High availability” on page 81](#). For more information about installing the FortiGate unit in NAT/Route mode, see [“Planning the FortiGate configuration” on page 54](#).

This chapter describes:

- [Preparing to configure NAT/Route mode](#)
- [Using the setup wizard](#)
- [Using the command line interface](#)
- [Completing the configuration](#)
- [Connecting the FortiGate unit to your networks](#)
- [Configuring your networks](#)
- [Completing the configuration](#)

Preparing to configure NAT/Route mode

Use [Table 20](#) to gather the information that you need to customize NAT/Route mode settings.

Table 20: NAT/Route mode settings

Administrator Password:		
Internal interface	IP:	____.____.____.____
	Netmask:	____.____.____.____

Table 20: NAT/Route mode settings (Continued)

External interface	IP:	_____ . _____ . _____ . _____
	Netmask:	_____ . _____ . _____ . _____
	Default Gateway:	_____ . _____ . _____ . _____
	Primary DNS Server:	_____ . _____ . _____ . _____
	Secondary DNS Server:	_____ . _____ . _____ . _____
Internal servers	Web Server:	_____ . _____ . _____ . _____
	SMTP Server:	_____ . _____ . _____ . _____
	POP3 Server:	_____ . _____ . _____ . _____
	IMAP Server:	_____ . _____ . _____ . _____
	FTP Server:	_____ . _____ . _____ . _____
If you provide access from the Internet to a web server, mail server, IMAP server, or FTP server installed on an internal network, add the IP addresses of the servers here.		

Advanced NAT/Route mode settings

Use [Table 21](#) to gather the information that you need to customize advanced FortiGate NAT/Route mode settings.

Table 21: Advanced FortiGate NAT/Route mode settings

External interface	DHCP:	If your Internet Service Provider (ISP) supplies you with an IP address using DHCP, no further information is required.	
	PPPoE:	User name:	_____
		Password:	_____
If your ISP supplies you with an IP address using PPPoE, record your PPPoE user name and password.			
DHCP server	Starting IP:	_____ . _____ . _____ . _____	
	Ending IP:	_____ . _____ . _____ . _____	
	Netmask:	_____ . _____ . _____ . _____	
	Default Route:	_____ . _____ . _____ . _____	
	DNS IP:	_____ . _____ . _____ . _____	
The FortiGate unit includes a DHCP server that you can configure to automatically set the addresses of the computers on your internal network.			

Out of band management interface

Use [Table 22](#) to record the IP address, netmask, and default gateway of the FortiGate-4000 out of band management interface if you are configuring this interface during installation.

Table 22: Out of band management interface (Optional)

IP:	_____ . _____ . _____ . _____	Netmask:	_____ . _____ . _____ . _____
Default Gateway:	_____ . _____ . _____ . _____		

Using the setup wizard

From the web-based manager, you can use the setup wizard to complete the initial configuration of the FortiGate unit. For information about connecting to the web-based manager, see [“Connecting to the web-based manager” on page 44](#).

Starting the setup wizard

- 1 In the web-based manager, select Easy Setup Wizard (the middle button in the upper-right corner of the web-based manager).
- 2 Select the Next button to step through the wizard pages.
- 3 Use the information that you gathered in [Table 20 on page 61](#) to fill in the wizard fields. You can also use the information in [Table 21 on page 62](#).
- 4 Confirm the configuration settings, and then select Finish and Close.



Note: If you use the setup wizard to configure internal server settings, the FortiGate unit adds port forwarding virtual IPs and firewall policies for each server. For example, for each server located on the Internal network the FortiGate unit adds an External->Internal firewall policy.

Reconnecting to the web-based manager

If you connected to the FortiGate unit using the internal interface and you changed the IP address of the internal interface while you were using the setup wizard, you must reconnect to the web-based manager using a new IP address. Browse to <https://> followed by the new IP address of the internal interface. Otherwise, you can reconnect to the web-based manager by browsing to <https://192.168.1.99>.

The IP address of the out of band management interface is not changed from the setup wizard. If you connected to the FortiGate unit using the out of band management interface you do not have to reconnect after completing the wizard.

You are now finished the initial configuration of your FortiGate unit, and can proceed to [“Completing the configuration” on page 66](#).

Using the command line interface

As an alternative to using the setup wizard, you can configure the FortiGate unit using the command line interface (CLI). For information about connecting to the CLI, see [“Connecting to the Command Line Interface \(CLI\)” on page 47](#).

Configuring the FortiGate unit to operate in NAT/Route mode

Use the information that you gathered in [Table 20 on page 61](#) to complete the following procedure.

Configuring NAT/Route mode IP addresses

- 1 Make sure that you are logged into the CLI.
- 2 Set the IP address and netmask of the internal interface to the internal IP address and netmask that you recorded in [Table 20 on page 61](#). Enter:

```
set system interface internal mode static ip <IP_address>
<netmask>
```

Example

```
set system interface internal mode static ip 192.168.1.1
255.255.255.0
```

- 3 Set the IP address and netmask of the external interface to the external IP address and netmask that you recorded in [Table 20 on page 61](#).

```
set system interface external mode static ip <IP_address>
<netmask>
```

Example

```
set system interface external mode static ip 204.23.1.5
255.255.255.0
```

To set the external interface to use DHCP, enter:

```
set system interface external mode dhcp connection enable
```

To set the external interface to use PPPoE, enter:

```
set system interface external mode pppoe username <user name>
password <password> connection enable
```

Example

```
set system interface external mode pppoe username
user@domain.com password mypass connection enable
```

- 4 Confirm that the addresses are correct. Enter:

```
get system interface
```

The CLI lists the IP address, netmask, and other settings for each of the FortiGate interfaces.

- 5 Set the primary DNS server IP addresses. Enter

```
set system dns primary <IP address>
```

Example

```
set system dns primary 293.44.75.21
```

- 6 Optionally, set the secondary DNS server IP addresses. Enter

```
set system dns secondary <IP address>
```

Example

```
set system dns secondary 293.44.75.22
```

- 7 Set the default route to the Default Gateway IP address (not required for DHCP and PPPoE).

```
set system route number <route_no> dst 0.0.0.0 0.0.0.0 gw1  
<gateway_ip>
```

Example

```
set system route number 0 dst 0.0.0.0 0.0.0.0 gw1 204.23.1.2
```

Configuring the out of band management interface

- 1 Make sure that you are logged into the CLI.
- 2 Set the out of band management IP address and netmask to the IP address and netmask that you recorded in [Table 22 on page 63](#). Enter:

```
set system oobmanagement ip <IP address> <netmask>
```

Example

```
set system oobmanagement ip 192.168.1.23 255.255.255.0
```

- 3 Set the out of band management default gateway if you must connect to the out of band management interface through a router. Enter:

```
set system oobmanagement gw <IP address> <netmask>
```

Example

```
set system oobmanagement gw 192.168.1.1 255.255.255.0
```

- 4 Confirm that the out of band management configuration is correct. Enter:

```
get system management
```

The CLI lists the management IP address and netmask.

Connecting the FortiGate unit to your networks

After you complete the initial configuration, you can connect the FortiGate unit between your internal network and the Internet.

- To connect the FortiGate-4000P, see [“FortiGate-4000P network connections” on page 39](#)
- To connect the FortiGate-4000S, see [“FortiGate-4000S network connections” on page 39](#)

Configuring your networks

If you are running the FortiGate unit in NAT/Route mode, your networks must be configured to route all Internet traffic to the IP address of the FortiGate interface to which they are connected.

Make sure that the connected FortiGate unit is functioning properly by connecting to the Internet from a computer on your internal network. You should be able to connect to any Internet address.

Completing the configuration

Use the information in this section to complete the configuration of the FortiGate unit.

Configuring the out of band management interface

Use the following procedure to configure the out of band management interface:

- 1 Log into the web-based manager.
- 2 Go to **System > Network > OOB Management**.
- 3 Change the IP/Netmask addresses and the Default Gateway using the information in [Table 22 on page 63](#).
- 4 Select Apply.

Setting the date and time

For effective scheduling and logging, the FortiGate system date and time must be accurate. You can either manually set the system date and time or configure the FortiGate unit to automatically keep its time correct by synchronizing with a Network Time Protocol (NTP) server.

For information about setting the FortiGate system date and time, see [“Setting system date and time” on page 175](#).

Changing antivirus protection

To change how antivirus protection to protects users on your internal network from downloading a virus from the Internet:

- 1 Go to **Firewall > Policy > Internal->External**.
- 2 Select Edit  to edit this policy.
- 3 Select Anti-Virus & Web filter to enable antivirus protection for this policy.
- 4 Select a different Content Profile to change how antivirus protection is applied for this policy.
For a description of each of the content profiles, see [“Content profiles” on page 223](#).
- 5 Select OK to save the changes.

Registering your FortiGate unit

After purchasing and installing a new FortiGate unit, you can register the unit by going to the System Update Support page, or using a web browser to connect to <http://support.fortinet.com> and selecting Product Registration.

To register, enter your contact information and the serial numbers of the FortiGate units that you or your organization have purchased. You can register multiple FortiGate units in a single session without re-entering your contact information.

For more information about registration, see [“Registering FortiGate units” on page 133](#).

Configuring virus and attack definition updates

You can go to the System Update page to configure the FortiGate unit to automatically check whether new versions of the virus definitions and attack definitions are available. If it finds new versions, the FortiGate unit automatically downloads and installs the updated definitions.

The FortiGate unit uses HTTPS on port 8890 to check for updates. The FortiGate external interface must have a path to the FortiResponse Distribution Network (FDN) using port 8890.

For information about configuring automatic virus and attack updates, see [“Updating antivirus and attack definitions” on page 123](#).

Transparent mode installation

This chapter describes how to install your FortiGate unit in Transparent mode. If you want to install the FortiGate unit in NAT/Route mode, see [“NAT/Route mode installation” on page 61](#). If you want to install two or more FortiGate units in HA mode, see [“High availability” on page 81](#).

This chapter describes:

- [Preparing to configure Transparent mode](#)
- [Using the setup wizard](#)
- [Using the command line interface](#)
- [Completing the configuration](#)
- [Connecting the FortiGate unit to your networks](#)
- [Transparent mode configuration examples](#)

Preparing to configure Transparent mode

Use [Table 23](#) to gather the information that you need to customize Transparent mode settings.

Table 23: Transparent mode settings

Administrator Password:		
Management IP	IP:	____ . ____ . ____ . ____
	Netmask:	____ . ____ . ____ . ____
	Default Gateway:	____ . ____ . ____ . ____
The management IP address and netmask must be valid for the network from which you will manage the FortiGate unit. Add a default gateway if the FortiGate unit must connect to a router to reach the management computer.		
DNS Settings	Primary DNS Server:	____ . ____ . ____ . ____
	Secondary DNS Server:	____ . ____ . ____ . ____

Out of band management interface

Use [Table 24](#) to record the IP address, netmask, and default gateway of the FortiGate-4000 out of band management interface if you are configuring this interface during installation.

Table 24: Out of band management interface (Optional)

IP:	_____ . _____ . _____ . _____	Netmask:	_____ . _____ . _____ . _____
Default Gateway:	_____ . _____ . _____ . _____		

Using the setup wizard

From the web-based manager, you can use the setup wizard to begin the initial configuration of the FortiGate unit. For information about connecting to the web-based manager, see [“Connecting to the web-based manager” on page 44](#).

Changing to Transparent mode using the web-based manager

The first time that you connect to the FortiGate unit, it is configured to run in NAT/Route mode.

To switch to Transparent mode using the web-based manager

- 1 Go to **System > Status**.
- 2 Select Change to Transparent Mode.
- 3 Select Transparent in the Operation Mode list.
- 4 Select OK.

To reconnect to the web-based manager using the internal interface, change the IP address of the management computer to 10.10.10.2. Connect to the internal interface and browse to `https://` followed by the Transparent mode management IP address. The default FortiGate Transparent mode management IP address is 10.10.10.1.

To reconnect to the web-based manager using the out of band management interface, change the IP address of the management computer to 172.16.1.3. Connect to the out of band management interface and browse to `https://172.16.1.2`.

Starting the setup wizard

- 1 Select Easy Setup Wizard (the middle button in the upper-right corner of the web-based manager).
- 2 Use the information that you gathered in [Table 23 on page 69](#) to fill in the wizard fields. Select the Next button to step through the wizard pages.
- 3 Confirm your configuration settings, and then select Finish and Close.

Reconnecting to the web-based manager

If you changed the IP address of the management interface while you were using the setup wizard, you must reconnect to the web-based manager using the new IP address. Browse to `https://` followed by the new IP address of the management interface. Otherwise, you can reconnect to the web-based manager by browsing to `https://10.10.10.1`. If you connect to the management interface through a router, make sure that you have added a default gateway for that router to the management IP default gateway field.

The IP address of the out of band management interface is not changed from the setup wizard. If you connected to the FortiGate unit using the out of band management interface you do not have to reconnect after completing the wizard.

Using the command line interface

As an alternative to the setup wizard, you can begin the initial configuration of the FortiGate unit using the command line interface (CLI). To connect to the CLI, see [“Connecting to the Command Line Interface \(CLI\)” on page 47](#). Use the information that you gathered in [Table 23 on page 69](#) to complete the following procedures.

Changing to Transparent mode using the CLI

- 1 Make sure that you are logged into the CLI.
- 2 Switch to Transparent mode. Enter:

```
set system opmode transparent
```

After a few seconds, the login prompt appears.
- 3 Type `admin` and press Enter.
The following prompt appears:
Type ? for a list of commands.
- 4 Confirm that the FortiGate unit has switched to Transparent mode. Enter:

```
get system status
```

The CLI displays the status of the FortiGate unit. The last line shows the current operation mode.
Operation mode: Transparent

Configuring the Transparent mode management IP address

- 1 Make sure that you are logged into the CLI.
- 2 Set the management IP address and netmask to the IP address and netmask that you recorded in [Table 23 on page 69](#). Enter:

```
set system management ip <IP address> <netmask>
```

Example

```
set system management ip 10.10.10.2 255.255.255.0
```
- 3 Confirm that the address is correct. Enter:

```
get system management
```

The CLI lists the management IP address and netmask.

Configure the Transparent mode default gateway

- 1 Make sure that you are logged into the CLI.
- 2 Set the default route to the default gateway that you recorded in [Table 23 on page 69](#). Enter:

```
set system route number <number> gw1 <IP address>
```

Example

```
set system route number 0 gw1 204.23.1.2
```

Configure the out of band management interface

- 1 Make sure that you are logged into the CLI.
- 2 Set the out of band management IP address and netmask to the IP address and netmask that you recorded in [Table 24 on page 70](#). Enter:

```
set system oobmanagement ip <IP address> <netmask>
```

Example

```
set system oobmanagement ip 192.168.1.23 255.255.255.0
```

- 3 Set the out of band management default gateway if you must connect to the out of band management interface through a router. Enter:

```
set system oobmanagement gw <IP address> <netmask>
```

Example

```
set system oobmanagement gw 192.168.1.1 255.255.255.0
```

- 4 Confirm that the out of band management configuration is correct. Enter:

```
get system management
```

The CLI lists the management IP address and netmask.

Completing the configuration

Use the information in this section to complete the initial configuration of the FortiGate unit.

Setting the date and time

For effective scheduling and logging, the FortiGate system date and time must be accurate. You can either manually set the system date and time or configure the FortiGate unit to automatically keep its time correct by synchronizing with a Network Time Protocol (NTP) server.

For information about setting the FortiGate system date and time, see [“Setting system date and time” on page 175](#).

Enabling antivirus protection

You can protect users on your internal network from downloading a virus from the Internet.

- 1 Go to **Firewall > Policy > Internal->External**.
- 2 Select Edit  to edit this policy.

- 3 Select Anti-Virus & Web filter to enable antivirus protection for this policy.
- 4 Select the Scan Content Profile.
- 5 Select OK to save the changes.

Registering your FortiGate unit

After purchasing and installing a new FortiGate unit, you can register the unit by going to the System Update Support page, or using a web browser to connect to <http://support.fortinet.com> and selecting Product Registration.

To register, enter your contact information and the serial numbers of the FortiGate units that you or your organization have purchased. You can register multiple FortiGate units in a single session without re-entering your contact information.

For more information about registration, see [“Registering FortiGate units” on page 133](#).

Configuring virus and attack definition updates

You can configure the FortiGate unit to automatically check whether new versions of the virus definitions and attack definitions are available. If it finds new versions, the FortiGate unit automatically downloads and installs the updated definitions.

The FortiGate unit uses HTTPS on port 8890 to check for updates. The FortiGate external interface must have a path to the FortiResponse Distribution Network (FDN) using port 8890.

For information about configuring automatic virus and attack updates, see [“Updating antivirus and attack definitions” on page 123](#).

Connecting the FortiGate unit to your networks

After you complete the initial configuration, you can connect the FortiGate unit between your internal network and the Internet.

- To connect the FortiGate-4000P, see [“FortiGate-4000P network connections” on page 39](#)
- To connect the FortiGate-4000S, see [“FortiGate-4000S network connections” on page 39](#)

Transparent mode configuration examples

A FortiGate unit operating in Transparent mode still requires a basic configuration to operate as a node on the IP network. As a minimum, the FortiGate unit must be configured with an IP address and subnet mask. These are used for management access and to allow the unit to receive antivirus and definitions updates. Also, the unit must have sufficient route information to reach:

- the management computer,
- The FortiResponse Distribution Network (FDN),
- a DNS server.

A route is required whenever the FortiGate unit connects to a router to reach a destination. If all the destinations are located on the external network, you might be required to enter only a single default route. If, however, the network topology is more complex, you might be required to enter one or more static routes in addition to the default route.

This section describes:

- [Default routes and static routes](#)
- [Example default route to an external network](#)
- [Example static route to an external destination](#)
- [Example static route to an internal destination](#)

Default routes and static routes

To create a route to a destination, you need to define an IP prefix which consists of an IP network address and a corresponding netmask value. A default route matches any prefix and forwards traffic to the next hop router (otherwise known as the default gateway). A static route matches a more specific prefix and forwards traffic to the next hop router.

Default route example

```
IP Prefix 0.0.0.0 (IP address)
          0.0.0.0 (Netmask)
Next Hop 192.168.1.2
```

Static Route example

```
IP Prefix 172.100.100.0 (IP address)
          255.255.255.0 (Netmask)
Next Hop 192.168.1.2
```



Note: When adding routes to the FortiGate unit, add the default route last so that it appears on the bottom of the route list. This makes sure that the unit attempts to match more specific routes before selecting the default route.

Web-based manager example configuration steps

To configure basic Transparent mode settings and a default route using the web-based manager

- 1 Go to **System > Status**.
 - Select Change to Transparent Mode.
 - Select Transparent in the Operation Mode list.
 - Select OK.
The FortiGate unit changes to Transparent mode.
- 2 Go to **System > Network > Management**.
 - Change the Management IP and Netmask:
IP: 192.168.1.1
Mask: 255.255.255.0
 - Select Apply.
- 3 Go to **System > Network > Routing**.
 - Select New to add the default route to the external network.
Destination IP: 0.0.0.0
Mask: 0.0.0.0
Gateway: 192.168.1.2
 - Select OK.

CLI configuration steps

To configure the Fortinet basic settings and a default route using the CLI:

- 1 Change the system to operate in Transparent Mode.

```
set system opmode transparent
```
- 2 Add the Management IP address and Netmask.

```
set system management ip 192.168.1.1 255.255.255.0
```
- 3 Add the default route to the external network.

```
set system route number 1 gw1 192.168.1.2
```

Example static route to an external destination

[Figure 24](#) shows a FortiGate unit that requires routes to the FDN located on the external network. The Fortigate unit does not require routes to the DNS servers or management computer because they are located on the internal network.

To connect to the FDN, you typically enter a single default route to the external network. However, for additional security, you can enter static routes to a specific FortiResponse server in addition to a default route to the external network. If the static route becomes unavailable (for example, because the IP address of the FortiResponse server changes) the FortiGate unit can still receive antivirus and NIDS updates from the FDN using the default route.



Note: This is an example configuration only. To configure a static route, you require a destination IP address.

Figure 24: Static route to an external destination

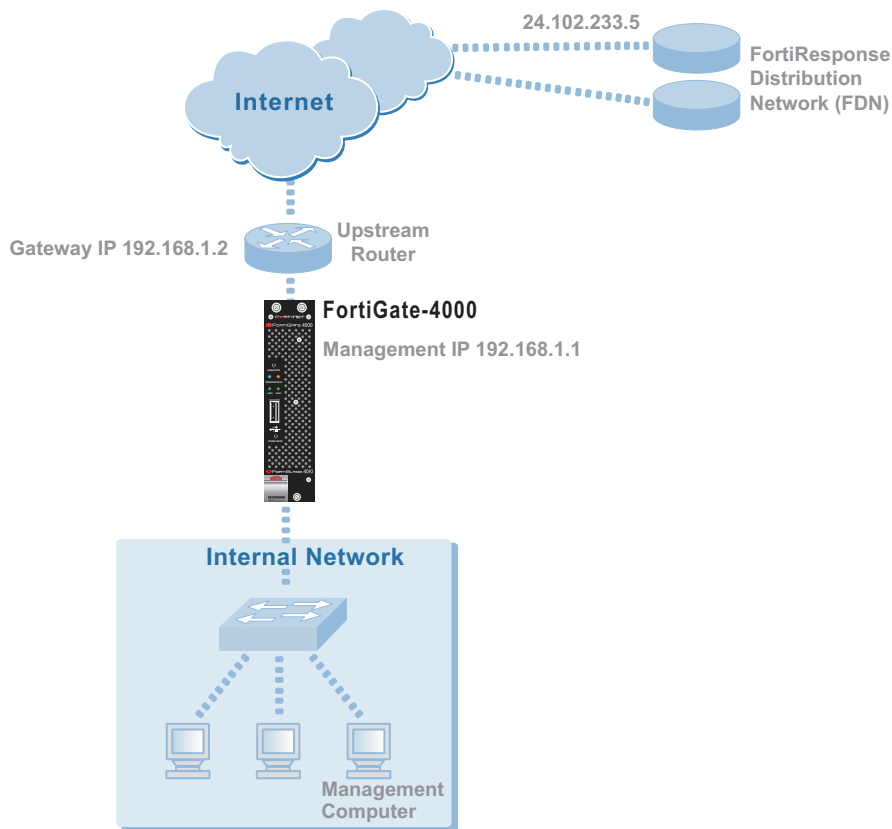

General configuration steps

- 1 Set the FortiGate unit to operate in Transparent mode.
- 2 Configure the Management IP address and Netmask of the FortiGate unit.
- 3 Configure the static route to the FortiResponse server.
- 4 Configure the default route to the external network.

Web-based manager example configuration steps

To configure the basic FortiGate settings and a static route using the web-based manager:

- 1 Go to **System > Status**.
 - Select Change to Transparent Mode.
 - Select Transparent in the Operation Mode list.
 - Select OK.

The FortiGate unit changes to Transparent mode.

- 2 Go to **System > Network > Management**.
 - Change the Management IP and Netmask:
IP: 192.168.1.1
Mask: 255.255.255.0
 - Select Apply.
- 3 Go to **System > Network > Routing**.
 - Select New to add the static route to the FortiResponse server.
Destination IP: 24.102.233.5
Mask: 255.255.255.0
Gateway: 192.168.1.2
 - Select OK.
 - Select New to add the default route to the external network.
Destination IP: 0.0.0.0
Mask: 0.0.0.0
Gateway: 192.168.1.2
 - Select OK.

CLI configuration steps

To configure the Fortinet basic settings and a static route using the CLI:

- 1 Set the system to operate in Transparent Mode.

```
set system opmode transparent
```
- 2 Add the Management IP address and Netmask.

```
set system management ip 192.168.1.1 255.255.255.0
```
- 3 Add the static route to the primary FortiResponse server.

```
set system route number 1 dst 24.102.233.5 255.255.255.0 gw1  
192.168.1.2
```
- 4 Add the default route to the external network.

```
set system route number 2 gw1 192.168.1.2
```

Example static route to an internal destination

Figure 25 shows a FortiGate unit where the FDN is located on an external subnet and the management computer is located on a remote, internal subnet. To reach the FDN, you need to enter a single default route that points to the upstream router as the next hop/default gateway. To reach the management computer, you need to enter a single static route that leads directly to it. This route points to the internal router as the next hop. (No route is required for the DNS servers because they are on the same layer 3 subnet as the FortiGate unit.)

Figure 25: Static route to an internal destination

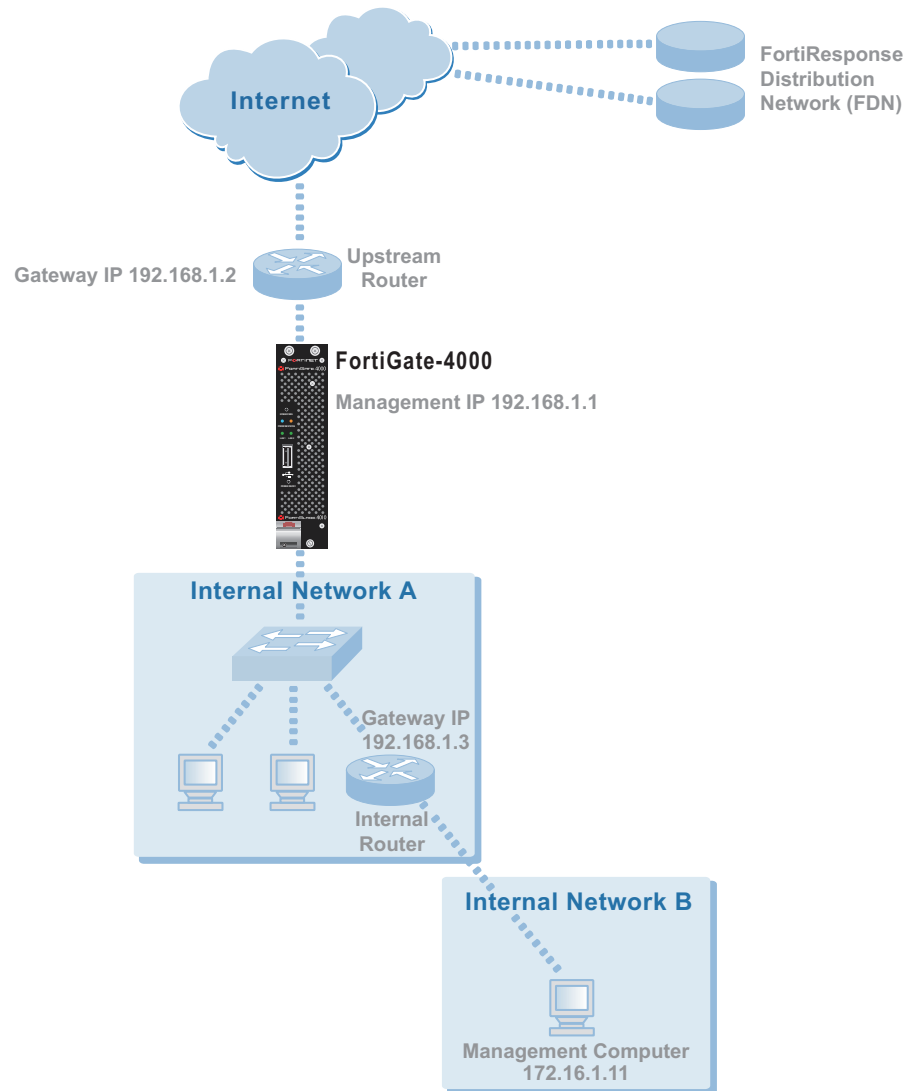

General configuration steps

- 1 Set the unit to operate in Transparent mode.
- 2 Configure the Management IP address and Netmask of the FortiGate unit.
- 3 Configure the static route to the management computer on the internal network.
- 4 Configure the default route to the external network.

Web-based manager example configuration steps

To configure the FortiGate basic settings, a static route, and a default route using the web-based manager:

- 1 Go to **System > Status**.
 - Select Change to Transparent Mode.
 - Select Transparent in the Operation Mode list.
 - Select OK.
The FortiGate unit changes to Transparent mode.
- 2 Go to **System > Network > Management**.
 - Change the Management IP and Netmask:
IP: 192.168.1.1
Mask: 255.255.255.0
 - Select Apply.
- 3 Go to **System > Network > Routing**.
 - Select New to add the static route to the management computer.
Destination IP: 172.16.1.11
Mask: 255.255.255.0
Gateway: 192.168.1.3
 - Select OK.
 - Select New to add the default route to the external network.
Destination IP: 0.0.0.0
Mask: 0.0.0.0
Gateway: 192.168.1.2
 - Select OK.

CLI configuration steps

To configure the FortiGate basic settings, a static route, and a default route using the CLI:

- 1 Set the system to operate in Transparent Mode.

```
set system opmode transparent
```
- 2 Add the Management IP address and Netmask.

```
set system management ip 192.168.1.1 255.255.255.0
```
- 3 Add the static route to the management computer.

```
set system route number 1 dst 172.16.1.11 255.255.255.0 gw1  
192.168.1.3
```
- 4 Add the default route to the external network.

```
set system route number 2 gw1 192.168.1.2
```

High availability

Fortinet achieves high availability (HA) using redundant hardware and the FortiGate Clustering Protocol (FGCP). Each FortiGate unit in an HA cluster uses the same overall security policy and shares the same configuration settings. You can add up to 32 FortiGate units to an HA cluster. Each FortiGate unit in an HA cluster must be the same model and must run the same FortiOS firmware image.

FortiGate HA is device redundant. If one of the FortiGate units in an HA cluster fails, all functions, all established firewall connections, and all IPsec VPN sessions¹ are maintained by the other FortiGate units in the HA cluster.

You manage the cluster by connecting to the cluster web-based manager from any cluster interface configured for HTTPS administrative access. You can also manage the cluster by connecting to the cluster CLI from any cluster interface configured for SSH administrative access. All configuration changes made to the cluster are automatically synchronized to all cluster members.

From the web-based manager you can monitor the status and log messages of the cluster and of each of the FortiGate units in the cluster. You can also monitor the cluster by using an SNMP manager to get SNMP information from or receive traps for any cluster interface configured for SNMP administrative access.

The FortiGate units in the cluster use dedicated HA ethernet interfaces to communicate cluster session information, synchronize the cluster configuration, and report individual system status. The units in the cluster constantly communicate HA status information to make sure that the cluster is operating properly. For this reason, the connection between the HA interface of all the FortiGate units in the cluster must be well maintained. An interruption of this communication can have unpredictable results.



Note: The HA interfaces of the FortiGate units in a cluster are assigned IP addresses during cluster negotiation. These IP addresses cannot be viewed using the web-based manager or the CLI. Attempting to change the IP address of an HA interface using the web-based manager or the CLI has no effect on the IP address assigned during cluster negotiation. HA interfaces only accept connections used for HA communication between units in the cluster. You cannot connect to the HA interfaces to manage the cluster or to manage individual FortiGate units in the cluster.

FortiGate units can be configured to operate in active-passive (A-P) or active-active (A-A) HA mode. Active-active and active-passive clusters can run in either NAT/Route or Transparent mode.

1. HA does not provide session failover for PPPoE, DHCP, PPTP, and L2TP services.

An active-passive (A-P) HA cluster, also referred to as hot standby HA, consists of a primary FortiGate unit that processes traffic, and one or more subordinate FortiGate units. The subordinate FortiGate units are connected to the network and to the primary FortiGate unit but do not process traffic.

Active-active (A-A) HA load balances virus scanning among all the FortiGate units in the cluster. An active-active HA cluster consists of a primary FortiGate unit that processes traffic and subordinate units that also process traffic. The primary FortiGate unit uses a load balancing algorithm to distribute virus scanning to all the FortiGate units in the HA cluster.

This chapter provides an overview of HA functionality and describes how to configure and manage HA clusters in NAT/Route mode and Transparent mode.

- [Configuring an HA cluster](#)
- [Managing an HA cluster](#)
- [Advanced HA options](#)
- [Active-Active cluster packet flow](#)

Configuring an HA cluster

Use the following procedures to create an HA cluster consisting of two or more FortiGate units. These procedures describe how to configure each of the FortiGate units for HA operation and then how to connect the FortiGate units to form a cluster. Once the cluster is connected you can configure it in the same way as you would configure a standalone FortiGate unit.

This section describes:

- [Configuring FortiGate units for HA operation](#)
- [Connecting the cluster](#)
- [Adding a new FortiGate unit to a functioning cluster](#)

Configuring FortiGate units for HA operation

Each FortiGate unit in the cluster must have the same HA configuration. Use the following procedure to configure each FortiGate unit for HA operation.

To configure a FortiGate unit for HA operation

- 1 Power on the FortiGate unit that you want to configure.
- 2 Connect to the web-based manager.
- 3 Give the FortiGate unit a unique host name.
See [“Changing the FortiGate host name” on page 102](#). Use host names to identify individual cluster units.
- 4 Go to **System > Config > HA**.
- 5 Select HA.

- 6 Select the HA mode.
Select Active-Active mode to create an Active-Active HA cluster.
Select Active-Passive mode to create an Active-Passive HA cluster.
The HA mode must be the same for all FortiGate units in the HA cluster.
 - 7 Enter and confirm a password for the HA cluster.
The password must be the same for all FortiGate units in the HA cluster.
 - 8 Select a Group ID for the HA cluster.
The Group ID must be the same for all FortiGate units in the HA cluster.
 - 9 If you are configuring Active-Active HA, select a schedule.
The schedule controls load balancing among the FortiGate units in the active-active HA cluster. The schedule must be the same for all FortiGate units in the HA cluster.
- | | |
|-----------------------------|--|
| None | No load balancing. Select None when the cluster interfaces are connected to load balancing switches. |
| Hub | Load balancing for hubs. Select Hub if the cluster interfaces are connected to a hub. Traffic is distributed to units in a cluster based on the Source IP and Destination IP of the packet. |
| Least Connection | Least connection load balancing. If the FortiGate units are connected using switches, select Least connection to distribute traffic to the cluster unit with the fewest concurrent connections. |
| Round Robin | Round robin load balancing. If the FortiGate units are connected using switches, select round robin to distribute traffic to the next available cluster unit. |
| Weighted Round Robin | Weighted round robin load balancing. Similar to round robin, but weighted values are assigned to each of the units in a cluster based on their capacity and on how many connections they are currently processing. For example, the primary unit should have a lower weighted value because it handles scheduling and forwards traffic. Weighted round robin distributes traffic more evenly because units that are not processing traffic will be more likely to receive new connections than units that are very busy. |
| Random | Random load balancing. If the FortiGate units are connected using switches, select random to randomly distribute traffic to cluster units. |
| IP | Load balancing according to IP address. If the FortiGate units are connected using switches, select IP to distribute traffic to units in a cluster based on the Source IP and Destination IP of the packet. |
| IP Port | Load balancing according to IP address and port. If the FortiGate units are connected using switches, select IP Port to distribute traffic to units in a cluster based on the Source IP, Source Port, Destination IP, and Destination port of the packet. |



Note: Do not configure Monitor on Interface until the FortiGate cluster is connected and functioning. See [“Configuring cluster interface monitoring”](#) on page 88.

- 10 Select Apply.
The FortiGate unit negotiates to establish an HA cluster. When you select apply you might temporarily lose connectivity with the FortiGate unit as the HA cluster negotiates.

Figure 26: Example Active-Active HA configuration

Standalone Mode
 HA: Active-Active

Password:
 Retype Password:
 Group ID: 7
 Schedule: Least-Connection
 Monitor on interface:
 external

Apply

- 11 If you are configuring a NAT/Route mode cluster, power off the FortiGate unit and then repeat this procedure for all the FortiGate units in the cluster. Once all the units are configured, proceed to [“Connecting the cluster” on page 84](#).
- 12 If you are configuring a Transparent mode cluster, reconnect to the web-based manager.
You might have to wait a few minutes before you can reconnect.
- 13 Go to **System > Status**.
- 14 Select Change to Transparent Mode and select OK to switch the FortiGate unit to Transparent mode.
- 15 Power off the FortiGate unit.
- 16 Repeat this procedure for all the FortiGate units in the cluster.

Connecting the cluster

Use the following procedure to connect a cluster operating in NAT/Route mode or Transparent mode. Connect the FortiGate units in the cluster to each other and to your network. You must connect all matching interfaces in the cluster to the same hub or switch. Then you must connect these interfaces to their networks using the same hub or switch.

Fortinet recommends using switches for all cluster connections for the best performance.

The FortiGate units in the cluster use dedicated HA ethernet interfaces to communicate HA status information to make sure the cluster is functioning properly. For this reason, the connection between the HA interfaces of all the FortiGate units in the cluster must be well maintained. An interruption of this communication can have unpredictable results.

Inserting an HA cluster into your network temporarily interrupts communications on the network because new physical connections are being made to route traffic through the cluster. Also, starting the cluster interrupts network traffic until the individual FortiGate units in the cluster are functioning and the cluster completes negotiation. Cluster negotiation normally takes just a few seconds. During system startup and negotiation all network traffic is dropped.

To connect the cluster**1** Connect the cluster units:

For FortiGate-4000S:

- Connect your internal network to the internal switched interface module.
- Connect your external network to the external switched interface module.

For FortiGate-4000P:

- Connect the internal pass-through interface module of each FortiGate unit to a switch or hub connected to your internal network.
- Connect the external pass-through interface module of each FortiGate unit to a switch or hub connected to your external network.

2 Power on all the FortiGate units in the cluster.

As the units power on they negotiate to choose the primary cluster unit and the subordinate units. This negotiation occurs with no user intervention.

When negotiation is complete the you can configure the cluster as if it was a single FortiGate unit. Use the information in [“NAT/Route mode installation” on page 61](#) or [“Transparent mode installation” on page 69](#) to configure the cluster interfaces, configure your network, and complete the cluster configuration.



Note: Do not change the HA interface IP address. The HA interface of each FortiGate unit in the cluster is assigned an IP address during cluster negotiation.

Use the information in [“Managing an HA cluster” on page 87](#) to log into and manage the cluster.

Figure 27: FortiGate-4000S HA network configuration

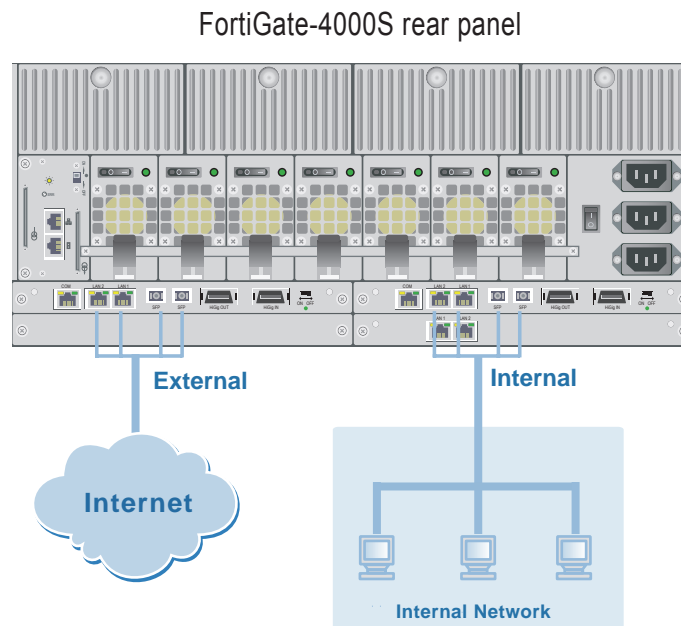

Managing an HA cluster

The configurations of all of the FortiGate units in the cluster are synchronized so that the FortiGate units can function as a cluster. Because of this synchronization, you manage the HA cluster instead of managing the individual FortiGate units in the cluster. You manage the cluster by connecting to the web-based manager or CLI using any interface configured for management access (except the HA interface). All units in the cluster are synchronized with the same interface IP addresses. Connecting to any interface IP address configured for management access connects to that cluster interface, which automatically connects you to the primary FortiGate unit in the cluster.

You can also use SNMP to manage the cluster by configuring a cluster interface for SNMP administrative access. Using an SNMP manager you can get cluster configuration information and receive traps.



Note: You cannot connect to the HA interfaces to manage the cluster or to manage individual FortiGate units in the cluster.

You can change the cluster configuration by connecting to the cluster and changing the configuration of the primary FortiGate unit. The cluster automatically synchronizes all configuration changes to the subordinate units in the cluster as the changes are made.

The only configuration change that is not synchronized is the FortiGate host name. You can give each cluster unit a unique host name to help to identify cluster members. For information about changing the host name of cluster members, see [“Changing cluster unit host names” on page 92](#).

You can use the web-based manager to monitor the status and logs of individual cluster members. See [“Monitoring cluster members” on page 89](#) and [“Viewing and managing cluster log messages” on page 90](#).

You can manage individual cluster units by using SSH to connect to the CLI of the cluster. From the CLI you can use the `execute ha manage` command to connect to the CLI of each unit in the cluster. You can also manage individual cluster units by using a null-modem cable to connect to the primary cluster unit. From there you can also use the `execute ha manage` command to connect to the CLI of each unit in the cluster. See [“Managing individual cluster units” on page 92](#) for more information.

This section describes:

- [Configuring cluster interface monitoring](#)
- [Viewing the status of cluster members](#)
- [Monitoring cluster members](#)
- [Viewing cluster sessions](#)
- [Viewing and managing cluster log messages](#)
- [Monitoring cluster units for failover](#)
- [Viewing cluster communication sessions](#)
- [Managing individual cluster units](#)
- [Changing cluster unit host names](#)
- [Synchronizing the cluster configuration](#)
- [Upgrading firmware](#)
- [Replacing a FortiGate unit after failover](#)

Configuring cluster interface monitoring

Monitor FortiGate interfaces to make sure that they are functioning properly and that they are connected to their networks. If a monitored interface fails or is disconnected from its network, the FortiGate unit stops processing traffic and is removed from the cluster. If you can re-establish traffic flow through the interface (for example, if you reconnect a disconnected network cable) the FortiGate unit rejoins the cluster.



Note: Only monitor interfaces that are connected to networks. You should not configure cluster interface monitoring until the cluster is connected to your network.

To monitor cluster interfaces

- 1 Connect to the cluster and log into the web-based manager.
- 2 Go to **System > Config > HA**.
- 3 In the Monitor on Interface section, select the names of the interfaces that you want to monitor.
- 4 Select Apply.

The cluster synchronizes this configuration change to all cluster units.

Viewing the status of cluster members

The web-based manager lists the serial numbers of all the FortiGate units in the cluster. The primary unit is identified as Local. For each cluster member, the list includes the up time and status for that cluster member.

To view the status of each cluster member

- 1 Connect to the cluster and log into the web-based manager.
- 2 Go to **System > Status > Cluster Members**.

Figure 29: Example cluster members list

Priority	Up Time	Status
Local	16 days 0 hours 27 minutes 0 seconds	✓
0-FPS3012803021709	12 days 0 hours 16 minutes 12 seconds	✓

Monitoring cluster members

To monitor health information for each cluster member

- 1 Connect to the cluster and log into the web-based manager.
- 2 Go to **System > Status > Monitor**.
 The cluster displays CPU, memory status, and hard disk status for each cluster member. The primary unit is identified as Local and the other units in the cluster are listed by serial number.
 The display includes bar graphs of current CPU and memory usage as well as line graphs of CPU and memory usage for the past minute.
 For more information, see [“Viewing CPU and memory status” on page 119](#).
- 3 Select Sessions & Network.
 The cluster displays sessions and network status for each cluster member. The primary unit is identified as Local and the other units in the cluster are listed by serial number.
 The display includes bar graphs of the current number of sessions and current network utilization as well as line graphs of session and network utilization usage for the last minute. The line graph scales are shown in the upper left corner of the graph.
 For more information, see [“Viewing sessions and network status” on page 120](#).

Figure 30: Example cluster CPU, memory, and hard disk display

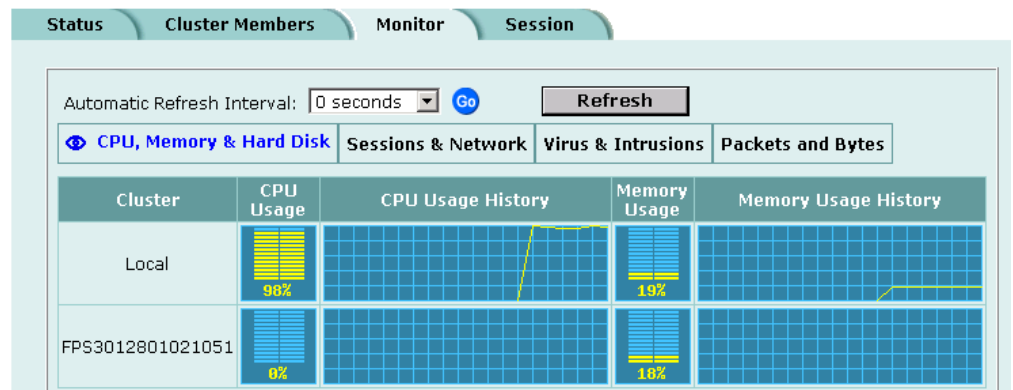

- 4 Select Virus & Intrusions.
The cluster displays virus and intrusions status for each cluster member. The primary unit is identified as Local and the other units in the cluster are listed by serial number. The display includes bar graphs of the number viruses and intrusions detected per hour as well as line graphs of the number of viruses and intrusions detected for the last 20 hours.
For more information, see [“Viewing virus and intrusions status” on page 121](#).
- 5 Select Packets & Bytes.
The cluster displays the number of packets and bytes processed by each cluster member.
To set the update frequency
 - 1 Select the automatic refresh interval.
 - 2 Select Go.
More frequent updates use more system resources and increase network traffic. However, this only occurs when you are viewing the display using the web-based manager.

Viewing cluster sessions

To view the cluster communication sessions

- 1 Connect to the cluster and log into the web-based manager.
- 2 Go to **System > Status > Session**.
The session table displays the sessions processed by the primary unit in the cluster, including HA communication sessions between the primary unit and the subordinate units. HA communications use:
 - Port 702 as the destination port,
 - From and To IP address on the 10.0.0.0 subnet.

During cluster negotiation, the HA interface of each cluster unit is assigned an IP address. The IP address of the primary unit is 10.0.0.1. The IP address of the first subordinate unit is 10.0.0.2. The IP address of the second subordinate unit is 10.0.0.3 and so on.

Viewing and managing cluster log messages

To view log messages for each cluster member

- 1 Connect to the cluster and log into the web-based manager.
- 2 Go to **Log&Report > Logging**.
The cluster displays the primary unit Traffic log, Event log, Attack log, Antivirus log, Web Filter log, and Email Filter log.
The pull-down list at the upper right of the display identifies the unit for which logs are displayed. The primary unit is identified as Local and the other units in the cluster are listed by serial number.

- 3 Select the serial number of one of the units in the cluster to display the logs for this cluster unit.
You can view logs saved to memory or logs saved to the hard disk, depending on the configuration of the cluster unit.
- 4 For each cluster unit:
 - If the cluster unit logs to memory you can view, search, and manage log messages. For more information, see [“Viewing logs saved to memory” on page 314](#).

Monitoring cluster units for failover

If the primary unit in the cluster fails, the units in the cluster renegotiate to select a new primary unit. Failure of the primary unit results in the following:

- If SNMP is enabled, the new primary FortiGate unit sends the trap message “HA switch”. This trap indicates that the primary unit in an HA cluster has failed and has been replaced with a new primary unit.
- The cluster contains fewer FortiGate units. The failed primary unit no longer appears on the Cluster Members list.
- The host name and serial number of the primary cluster unit changes.
- The new primary unit logs the following messages to the event log:

```
HA slave became master
Detected HA member dead
```

If a subordinate unit fails, the cluster continues to function normally. Failure of a subordinate unit results in the following:

- The cluster contains fewer FortiGate units. The failed unit no longer appears on the Cluster Members list.
- The master unit logs the following message to the event log:

```
Detected HA member dead
```

Viewing cluster communication sessions

- 1 Connect to the cluster and log into the web-based manager.
- 2 Go to **System > Status > Session**.

The session table displays the sessions processed by the primary unit in the cluster, including HA communication sessions between the primary unit and the subordinate units. HA communications use:

- Port 702 as the destination port,
- From and To IP address on the 10.0.0.0 subnet.

During cluster negotiation, the HA interface of each cluster unit is assigned an IP address. The IP address of the primary unit is 10.0.0.1. The IP address of the first subordinate unit is 10.0.0.2. The IP address of the second subordinate unit is 10.0.0.3 and so on.

Managing individual cluster units

You can connect to the CLI of each unit in the cluster. This procedure describes how to log into the primary unit CLI and from there connect to the CLI of subordinate cluster units. You log into the subordinate unit with the `ha_admin` administrator account. This built-in administrator account gives you read & write permission on the subordinate unit. For information about administration accounts and permissions, see [“Adding and editing administrator accounts” on page 178](#).

To manage a cluster unit

- 1 Use SSH to connect to the cluster and log into the CLI.
Connect to any cluster interface configured for SSH management to log into the cluster.
You can also use a direct cable connection to log into the primary unit CLI. (To do this you must know which unit is the primary unit. See [“Selecting a FortiGate unit as a permanent primary unit” on page 95](#) to control which FortiGate unit becomes the primary unit).
- 2 Enter the following command followed by a space and type a question mark (?):

```
execute ha manage
```

The CLI displays a list of all the subordinate units in the cluster. Each cluster unit is numbered, starting at 1. The information displayed for each cluster unit includes the unit serial number and host name of the unit.
- 3 Complete the command with the number of the subordinate unit to log into. For example, to log into subordinate unit 1, enter the following command:

```
execute ha manage 1
```

Press Enter and you are connected to and logged into the CLI of the selected subordinate unit. If this subordinate unit has a different host name, the CLI prompt changes to this host name. You can use CLI commands to manage this subordinate unit.
- 4 Enter the following command to return to the primary unit CLI:

```
exit
```

You can use the `execute ha manage` command to log into the CLI of any of the other subordinate units in the cluster.

Changing cluster unit host names

You can identify individual cluster units by giving each unit a unique host name. The host name is the only configuration setting not synchronized by the cluster.

To set the host name of each cluster member

- 1 Use SSH to connect to the cluster and log into the CLI.
- 2 Enter the following command to change the host name of the primary unit:

```
set system hostname <hostname_str>
```
- 3 Use the information in [“Managing individual cluster units” on page 92](#) to log into each cluster member.
- 4 Enter the following command to change the host name of the cluster member.

```
set system hostname <hostname_str>
```
- 5 Repeat steps 3 and 4 for each cluster member.

Synchronizing the cluster configuration

Cluster synchronization keeps all units in the cluster synchronized with the master unit. This includes:

- System configuration
- Virus definition updates
- Attack definition updates
- Web filter lists
- Email filter lists
- Replacement messages
- CA certificates
- Local certificates

Synchronization with all cluster members occurs in real time as the administrator changes or adds configuration settings to the primary unit. When the primary unit downloads antivirus or attack definition updates, all cluster members also receive these updates.

From each subordinate unit, you can also use the `execute ha synchronize` command to manually synchronize its configuration with the primary unit. Using this command you can synchronize the following:

Table 25: execute ha synchronize keywords

Keyword	Description
<code>config</code>	Synchronize the FortiGate configuration. This includes normal system configuration, firewall configuration, VPN configuration and so on stored in the FortiGate configuration file.
<code>avupd</code>	Synchronize the antivirus engine and antivirus definitions received by the primary unit from the FortiResponse Distribution Network (FDN).
<code>attackdef</code>	Synchronize NIDS attack definition updates received by the primary unit from the FDN.
<code>weblists</code>	Synchronize web filter lists added to or changed on the primary unit.
<code>emaillists</code>	Synchronize email filter lists added to or changed on the primary unit.
<code>resmsg</code>	Synchronize replacement messages changed on the primary unit.
<code>ca</code>	Synchronize CA certificates added to the primary unit.
<code>localcert</code>	Synchronize local certificates added to the primary unit.
<code>all</code>	Synchronize all of the above.

To manually synchronize the configuration of subordinate units with the primary unit

- 1 Connect to the cluster and log into the CLI.
- 2 Connect to the CLI of each of the subordinate units in the cluster.
For information about connecting to subordinate units, see [“Managing individual cluster units” on page 92](#).
- 3 Use the `execute ha synchronize` command to synchronize the configuration of the subordinate unit.
- 4 Repeat steps 2 and 3 for all the subordinate units in the HA cluster.

Upgrading firmware

To upgrade the firmware of the FortiGate units in a cluster, you must upgrade the firmware of each unit separately. In most cases, if you are upgrading to a new firmware build within the same firmware version (for example, upgrading from 2.50 build069 to 2.50 build070), you can do firmware upgrades using the following procedure and without interrupting cluster operation. This procedure involves uploading a new firmware image to the primary unit. Once the firmware image is uploaded, the primary unit restarts, running the new firmware version. When the primary unit restarts, it is removed from the cluster, which fails over to a new primary unit. During the failover, service might be interrupted if the cluster is very busy. Because of this interruption and in case the firmware upgrade fails, you should do this procedure only during off peak times when the cluster is not busy.



Note: if you are upgrading to a new firmware version (for example, from 2.50 to 2.80) and in some cases if you are upgrading to a new maintenance release of the same firmware version, you must remove individual units from the cluster. For more information, see [“Changing the FortiGate firmware” on page 102](#).

To upgrade the firmware version for all the units in a cluster

- 1 Copy the firmware image file to your management computer.
- 2 Connect to the cluster and log into the web-based manager as the admin administrative user.
- 3 Go to **System > Status**.
- 4 Select Firmware Upgrade .
- 5 Enter the path and filename of the firmware image file, or select Browse and locate the file.
- 6 Select OK.
The primary FortiGate unit uploads the firmware image file, upgrades to the new firmware version, and restarts. When this happens the primary FortiGate unit is removed from the cluster and one of the subordinate units becomes the new primary unit. After the failover occurs you can log into the cluster again to connect to the new primary unit.
- 7 Connect to the cluster and log into the web-based manager as the admin administrative user.
- 8 Repeat steps 3 to 7 for each cluster unit.

Once the firmware upgrade is finished for all the FortiGate units in the cluster, log into the cluster and update antivirus and attack definitions for the cluster. For information about updating antivirus and attack definitions, see [“Manually initiating antivirus and attack definitions updates” on page 125](#).

Replacing a FortiGate unit after failover

A failover can occur because of a hardware or software problem. When a failover occurs, you can attempt to restart the failed FortiGate unit by cycling its power. If the FortiGate unit starts up correctly, it rejoins the HA cluster, which then continues to function normally. If the FortiGate unit does not restart normally or does not rejoin the HA cluster, you must take it out of the network and either reconfigure or replace it.

Once the FortiGate unit is reconfigured or replaced, change its HA configuration to match the FortiGate unit that failed and reconnect it to the network. The reconnected FortiGate unit then automatically joins the HA cluster.

Advanced HA options

You can configure the following advanced HA options using the FortiGate CLI:

- [Selecting a FortiGate unit as a permanent primary unit](#)
- [Configuring the priority of each FortiGate unit in the cluster](#)
- [Configuring weighted-round-robin weights](#)

Selecting a FortiGate unit as a permanent primary unit

In a typical FortiGate cluster configuration, the primary unit is selected automatically. In some situations, you might want to control which unit becomes the primary unit. You can select a FortiGate unit as the permanent primary unit by changing its priority and configuring it to override any other primary unit.

To select a permanent primary unit

- 1 Connect to the CLI of the FortiGate unit that you want to become the permanent primary unit.
- 2 Set the priority of the permanent primary unit. Enter:

```
set system ha priority <priority_int>
```

Where `<priority_int>` is the priority to set for the permanent primary unit. The unit with the lowest priority becomes the primary unit. The default priority is 128. Set the priority of the permanent primary unit to a number lower than 128.
For example, to set the priority of the permanent primary unit to 10, enter the command:

```
set system ha priority 10
```
- 3 Make sure that the priority of all the other units in the cluster is higher than the priority of the permanent primary unit.
The command `get system ha mode` displays the current priority of the FortiGate unit that you are connected to.
- 4 Configure the permanent primary unit to override an existing primary unit when it joins the cluster. Use the following command to configure primary unit override:

```
set system ha override enable
```

Enable override so that the permanent primary unit overrides any other primary unit. For example, if the permanent primary unit shuts down, one of the other units in the cluster replaces it as the primary unit. When the permanent primary unit is restarted, it can become the primary unit again only if override is enabled.

Configuring the priority of each FortiGate unit in the cluster

In addition to selecting a permanent primary FortiGate unit, you can set the priorities of each of the subordinate units in the cluster to control the failover path. For example, if you have three FortiGate units in an HA cluster and you configured one as the permanent primary FortiGate unit, you might always want the cluster to failover to the same FortiGate unit if the primary unit fails.

If you have many FortiGate units in the cluster, you can assign a different priority to each of them to create a failover path.

To set the priority of each FortiGate unit in a cluster

- 1 Connect to the cluster and log into the CLI.
- 2 Select a permanent primary unit by following all the steps in the procedure [“Selecting a FortiGate unit as a permanent primary unit” on page 95](#).

- 3 From the primary unit CLI, enter the following command to log into a subordinate cluster member:

```
execute ha manage <cluster-member_int>
```

- 4 Set the priority of the cluster member. Enter:

```
set system ha priority <priority_int>
```

Where `<priority_int>` is the priority to set for the permanent primary unit. The permanent primary unit must have the lowest priority. The unit with the second lowest priority always becomes the new primary unit if the permanent primary unit fails. The default priority is 128.

For example, to set the priority of a cluster unit to 20, enter the command:

```
set system ha priority 20
```

- 5 Enter the command `exit` to return to the primary unit CLI.
- 6 Repeat steps 3 to 5 for each cluster unit.

Configuring weighted-round-robin weights

By default, in active-active HA mode the weighted round-robin schedule assigns the same weight to each FortiGate unit in the cluster. If you configure a cluster to use the weighted round-robin schedule, you can use the `set system ha weight` command to configure a weight value for each cluster unit. The weight value sets the maximum number of connections that are sent to a cluster unit before a connection can be sent to the next cluster unit. You can set weight values to control the number of connections processed by each cluster unit. For example, you might want to reduce the number of connections processed by the primary cluster unit by increasing the weight assigned to the subordinate cluster units.

Weight values are entered in order according to the priority of the units in the cluster. For example, if you have a cluster of three FortiGate units, you can enter the following command to configure the weight values for each unit:

```
set system ha weight 1 3 3
```

This command has the following results:

- The first connection is processed by the primary unit
- The next three connections are processed by the first subordinate unit
- The next three connections are processed by the second subordinate unit

The subordinate units process more connections than the primary unit, and both subordinate units, on average, process the same number of connections.

Active-Active cluster packet flow

This section describes packet flow through an active-active HA cluster. The cluster consists of two FortiGate units (primary and subordinate). Cluster interfaces are connected using switches.

- [NAT/Route mode packet flow](#)
- [Configuring switches to work with a NAT/Route mode cluster](#)
- [Transparent mode packet flow](#)

Figure 31: Active-active HA packet flow

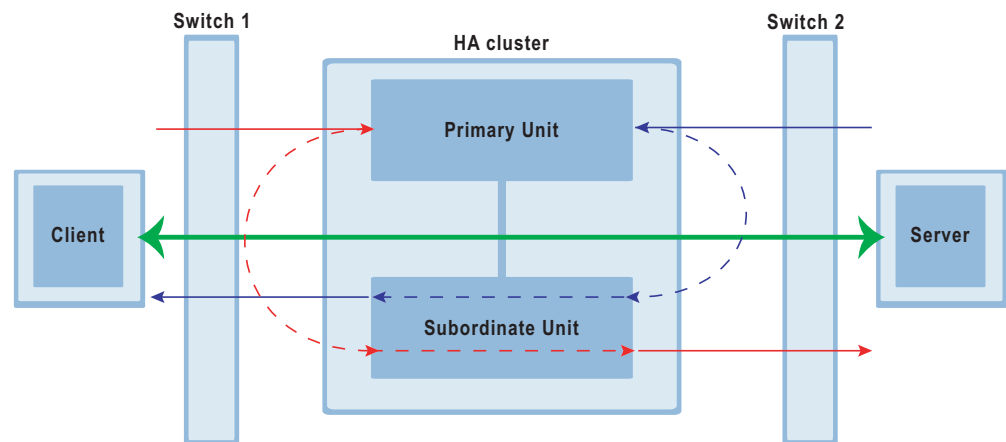

NAT/Route mode packet flow

In NAT/Route mode, five MAC addresses are involved in active-active communication between a client and a server if the cluster routes the packets to the subordinate unit in the cluster:

- Virtual cluster MAC address (MAC_V)
- Client MAC address (MAC_C),
- Server MAC address (MAC_S),
- Subordinate unit internal MAC address (MAC_S_I),
- Subordinate unit external MAC address (MAC_S_E).

In NAT/Route mode, the HA cluster works as a gateway when it responds to ARP requests. Therefore, the client and the server only know the gateway MAC address (MAC_V), which is a virtual MAC address created by the HA cluster. The virtual MAC address is 00-09-0f-06-ff-00.

Switch 1 and 2 know where the virtual MAC address and the real MAC address are. Packets are routed through the subordinate unit as follows.

A request packet from a client on the internal network to a server on the external network:

- 1 Source is MAC_C and destination is MAC_V (from client to primary)
- 2 Source is MAC_V and destination is MAC_S_I (from primary to subordinate internal)
- 3 Source is MAC_S_E and destination is MAC_S (from subordinate external to server)

A response packet from a server on the external network to a client on the internal network:

- 1 Source is MAC_S and destination is MAC_V (from server to primary)
- 2 Source is MAC_V and destination is MAC_S_E (from primary to subordinate external)
- 3 Source is MAC_S_I and destination is MAC_C (from subordinate internal to client)

Configuring switches to work with a NAT/Route mode cluster

Some switch vendors use a Global MAC address table for the entire switch instead of multiple MAC address tables, one for each interface and VLAN. The Global MAC address table feature causes interoperability problems with FortiGate HA. For a switch to work with FortiGate HA, the switch should support and be configured to use individual MAC address tables for each switch interface.

The following are examples of switches that are compatible with the FGCP because they use a Global MAC address table:

- HP 4100 GL series,
- HP2628,
- HP5300,
- Cisco Catalyst,
- Cisco 2850,
- Cisco 3550,
- Nortel PP8600,
- Nortel XLR.

Transparent mode packet flow

In transparent mode, six MAC addresses are involved in active-active communication between a client and a server if the cluster routes the packets to the subordinate unit in the cluster:

- Client MAC address (MAC_C),
- Server MAC address (MAC_S),
- Primary unit internal MAC address (MAC_P_I),
- Primary unit external MAC address (MAC_P_E),
- Subordinate unit internal MAC address (MAC_S_I),
- Subordinate unit external MAC address (MAC_S_E).

A request packet from a client on the internal network to a server on the external network:

- 1 Source is MAC_C and destination is MAC_S (from client to primary)
- 2 Source is MAC_P_I and destination is MAC_S_I (from primary internal to subordinate internal)
- 3 Source is MAC_S_E and destination is MAC_S (from subordinate external to server)

A response packet from a server on the external network to a client on the internal network:

- 1 Source is MAC_S and destination is MAC_C (from server to primary)
- 2 Source is MAC_P_E and destination is MAC_S_E (from primary external to subordinate external)
- 3 Source is MAC_S_I and destination is MAC_C (from subordinate internal to client)

System status

You can connect to the web-based manager and view the current system status of the FortiGate unit. The status information that is displayed includes the current firmware version, the current virus and attack definitions, and the FortiGate unit serial number.

If you log into the web-based manager using the admin administrator account, you can make any of the following changes to the FortiGate system settings:

- [Changing the FortiGate host name](#)
- [Changing the FortiGate firmware](#)
- [Manual virus definition updates](#)
- [Manual attack definition updates](#)
- [Backing up system settings](#)
- [Restoring system settings](#)
- [Restoring system settings to factory defaults](#)
- [Changing to Transparent mode](#)
- [Changing to NAT/Route mode](#)
- [Restarting the FortiGate unit](#)
- [Shutting down the FortiGate unit](#)

If you log into the web-based manager with another administrator account, you can view the system settings including:

- [Displaying the FortiGate serial number](#)
- [Displaying the FortiGate up time](#)

All administrative users can also go to the Monitor page and view FortiGate system status. System status displays FortiGate system health monitoring information, including CPU and memory status, session and network status.

- [System status](#)

All administrative users can also go to the Session page and view the active communication sessions to and through the FortiGate unit.

- [Session list](#)

Changing the FortiGate host name

The FortiGate host name appears on the Status page and in the FortiGate CLI prompt. The host name is also used as the SNMP system name. For information about the SNMP system name, see [“Configuring SNMP” on page 180](#).

The default host name is FortiGate-4000.

To change the FortiGate host name

- 1 Go to **System > Status**.
- 2 Select Edit Host Name .
- 3 Type a new host name.
- 4 Select OK.

The new host name is displayed on the Status page, and in the CLI prompt, and is added to the SNMP System Name.

Changing the FortiGate firmware

After you download a FortiGate firmware image from Fortinet, you can use the procedures listed in [Table 26](#) to install the firmware image on your FortiGate unit.

Table 26: Firmware upgrade procedures

Procedure	Description
Upgrading to a new firmware version	Commonly-used web-based manager and CLI procedures to upgrade to a new FortiOS firmware version or to a more recent build of the same firmware version.
Reverting to a previous firmware version	Use the web-based manager or CLI procedure to revert to a previous firmware version. This procedure reverts the FortiGate unit to its factory default configuration.
Installing firmware images from a system reboot using the CLI	Use this procedure to install a new firmware version or revert to a previous firmware version. You must run this procedure by connecting to the CLI using the FortiGate console port and a null-modem cable. This procedure reverts the FortiGate unit to its factory default configuration.
Testing a new firmware image before installing it	Use this procedure to test a new firmware image before installing it. You must run this procedure by connecting to the CLI using the FortiGate console port and a null-modem cable. This procedure temporarily installs a new firmware image using your current configuration. You can test the firmware image before installing it permanently. If the firmware image works correctly you can use one of the other procedures listed in this table to install it permanently.
Installing and using a backup firmware image	If the FortiGate unit is running BIOS version v3.x, you can install a backup firmware image. Once the backup firmware image is installed you can switch to this backup image when required.

Upgrading to a new firmware version

Use the following procedures to upgrade the FortiGate unit to a newer firmware version.

Upgrading the firmware using the web-based manager



Note: Installing firmware replaces the current antivirus and attack definitions with the definitions included with the firmware release that you are installing. After you install new firmware, use the procedure

To upgrade the firmware using the web-based manager

- 1 Copy the firmware image file to your management computer.
- 2 Log into the web-based manager as the admin administrative user.
- 3 Go to **System > Status**.
- 4 Select Firmware Upgrade .
- 5 Type the path and filename of the firmware image file, or select Browse and locate the file.
- 6 Select OK.
The FortiGate unit uploads the firmware image file, upgrades to the new firmware version, restarts, and displays the FortiGate login. This process takes a few minutes.
- 7 Log into the web-based manager.
- 8 Go to **System > Status** and check the Firmware Version to confirm that the firmware upgrade is successfully installed.
- 9 Update antivirus and attack definitions. For information about antivirus and attack definitions, see [“Manually initiating antivirus and attack definitions updates” on page 125](#).

Upgrading the firmware using the CLI

To use the following procedure you must have a TFTP server that the FortiGate unit can connect to.

To upgrade the firmware using the CLI

- 1 Make sure that the TFTP server is running.
- 2 Copy the new firmware image file to the root directory of the TFTP server.
- 3 Log into the CLI as the admin administrative user.

- 4 Make sure the FortiGate unit can connect to the TFTP server.
You can use the following command to ping the computer running the TFTP server.
For example, if the IP address of the TFTP server is 192.168.1.168:

```
execute ping 192.168.1.168
```
- 5 Enter the following command to copy the firmware image from the TFTP server to the FortiGate unit:

```
execute restore image <name_str> <tftp_ip>
```

Where `<name_str>` is the name of the firmware image file on the TFTP server and `<tftp_ip>` is the IP address of the TFTP server. For example, if the firmware image file name is `FGT_300-v250-build045-FORTINET.out` and the IP address of the TFTP server is `192.168.1.168`, enter:

```
execute restore image FGT_300-v250-build045-FORTINET.out  
192.168.1.168
```

The FortiGate unit uploads the firmware image file, upgrades to the new firmware version, and restarts. This process takes a few minutes.
- 6 Reconnect to the CLI.
- 7 To confirm that the new firmware image is successfully installed, enter:

```
get system status
```
- 8 Use the procedure [“Manually initiating antivirus and attack definitions updates” on page 125](#) to update antivirus and attack definitions, or from the CLI, enter:

```
execute updatecenter updatenow
```
- 9 To confirm that the antivirus and attack definitions are successfully updated, enter the following command to display the antivirus engine, virus and attack definitions version, contract expiry, and last update attempt information.

```
get system objver
```

Reverting to a previous firmware version

Use the following procedures to revert your FortiGate unit to a previous firmware version.

Reverting to a previous firmware version using the web-based manager

The following procedures revert the FortiGate unit to its factory default configuration and delete NIDS user-defined signatures, web content lists, email filtering lists, and changes to replacement messages.

Before beginning this procedure you can:

- Back up the FortiGate unit configuration. For information, see [“Backing up system settings” on page 115](#).
- Back up the NIDS user-defined signatures. For information, see the *FortiGate NIDS Guide*.
- Back up web content and email filtering lists. For information, see the *FortiGate Content Protection Guide*.

If you are reverting to a previous FortiOS version (for example, reverting from FortiOS v2.50 to FortiOS v2.36) you might not be able to restore the previous configuration from the backup configuration file.



Note: Installing firmware replaces the current antivirus and attack definitions with the definitions included with the firmware release that you are installing. After you install new firmware, use the procedure [“Manually initiating antivirus and attack definitions updates”](#) on page 125 to make sure that antivirus and attack definitions are up to date.

To revert to a previous firmware version using the web-based manager

- 1 Copy the firmware image file to your management computer.
- 2 Log into the FortiGate web-based manager as the admin administrative user.
- 3 Go to **System > Status**.
- 4 Select Firmware Upgrade .
- 5 Type the path and filename of the previous firmware image file, or select Browse and locate the file.
- 6 Select OK.
The FortiGate unit uploads the firmware image file, reverts to the old firmware version, resets the configuration, restarts, and displays the FortiGate login. This process takes a few minutes.
- 7 Log into the web-based manager.
For information about logging into the web-based manager when the FortiGate unit is set to factory defaults, see [“Connecting to the web-based manager”](#) on page 44.
- 8 Go to **System > Status** and check the Firmware Version to confirm that the firmware is successfully installed.
- 9 Restore your configuration.
For information about restoring your configuration, see [“Restoring system settings”](#) on page 116.
- 10 Update antivirus and attack definitions. For information about antivirus and attack definitions, see [“Manually initiating antivirus and attack definitions updates”](#) on page 125.

Reverting to a previous firmware version using the CLI

This procedure reverts your FortiGate unit to its factory default configuration and deletes NIDS user-defined signatures, web content lists, email filtering lists, and changes to replacement messages.

Before beginning this procedure you can:

- Back up the FortiGate unit configuration using the command `execute backup config`.
- Back up the NIDS user defined signatures using the command `execute backup nidsuserdefsig`
- Back up web content and email filtering lists. For information, see the *FortiGate Content Protection Guide*.

If you are reverting to a previous FortiOS version (for example, reverting from FortiOS v2.50 to FortiOS v2.36) you might not be able to restore your previous configuration from the backup configuration file.



Note: Installing firmware replaces the current antivirus and attack definitions with the definitions included with the firmware release that you are installing. After you install new firmware, use the procedure [“Manually initiating antivirus and attack definitions updates”](#) on page 125 to make sure that antivirus and attack definitions are up to date. You can also use the CLI command `execute update antivirus`

To use the following procedure you must have a TFTP server that the FortiGate unit can connect to.

To revert to a previous firmware version using the CLI

- 1 Make sure that the TFTP server is running.
- 2 Copy the new firmware image file to the root directory of the TFTP server.
- 3 Log into the FortiGate CLI as the admin administrative user.
- 4 Make sure the FortiGate unit can connect to the TFTP server.
You can use the following command to ping the computer running the TFTP server. For example, if the TFTP server's IP address is 192.168.1.168:

```
execute ping 192.168.1.168
```

- 5 Enter the following command to copy the firmware image from the TFTP server to the FortiGate unit:

```
execute restore image <name_str> <tftp_ip>
```

Where `<name_str>` is the name of the firmware image file on the TFTP server and `<tftp_ip>` is the IP address of the TFTP server. For example, if the firmware image file name is `FGT_300-v250-build045-FORTINET.out` and the IP address of the TFTP server is `192.168.1.168`, enter:

```
execute restore image FGT_300-v250-build045-FORTINET.out
192.168.1.168
```

The FortiGate unit uploads the firmware image file. After the file uploads, a message similar to the following is displayed:

```
Get image from tftp server OK.
This operation will downgrade the current firmware version!
Do you want to continue? (y/n)
```

- 6 Type Y.
- 7 The FortiGate unit reverts to the old firmware version, resets the configuration to factory defaults, and restarts. This process takes a few minutes.
- 8 Reconnect to the CLI.
For information about logging into the CLI when the FortiGate unit is set to factory defaults, see [“Connecting to the Command Line Interface \(CLI\)”](#) on page 47.
- 9 To confirm that the new firmware image has been loaded, enter:

```
get system status
```
- 10 Restore your previous configuration. Use the following command:

```
execute restore config
```

- 11 Update antivirus and attack definitions. For information, see [“Manually initiating antivirus and attack definitions updates”](#) on page 125, or from the CLI, enter:

```
execute updatecenter updatenow
```
- 12 To confirm that the antivirus and attack definitions have been updated, enter the following command to display the antivirus engine, virus and attack definitions version, contract expiry, and last update attempt information.

```
get system objver
```

Installing firmware images from a system reboot using the CLI

This procedure installs a specified firmware image and resets the FortiGate unit to default settings. You can use this procedure to upgrade to a new firmware version, revert to an older firmware version, or re-install the current firmware version.



To perform this procedure you:

- access the CLI by connecting to the FortiGate console port using a null-modem cable,
- install a TFTP server that you can connect to from the FortiGate internal interface. The TFTP server should be on the same subnet as the internal interface.

Before beginning this procedure you can:

- Back up the FortiGate unit configuration. For information, see [“Backing up system settings”](#) on page 115.
- Back up the NIDS user defined signatures. For information, see the *FortiGate NIDS Guide*.
- Back up web content and email filtering lists. For information, see the *FortiGate Content Protection Guide*.

If you are reverting to a previous FortiOS version (for example, reverting from FortiOS v2.50 to FortiOS v2.36) you might not be able to restore your previous configuration from the backup configuration file.

To install firmware from a system reboot

- 1 Connect to the CLI using the null-modem cable and FortiGate console port.
- 2 Make sure that the TFTP server is running.
- 3 Copy the new firmware image file to the root directory of the TFTP server.
- 4 Make sure that the internal interface is connected to the same network as the TFTP server.

- 5 To confirm that the FortiGate unit can connect to the TFTP server, use the following command to ping the computer running the TFTP server. For example, if the IP address of the TFTP server is 192.168.1.168, enter:

```
execute ping 192.168.1.168
```

- 6 Enter the following command to restart the FortiGate unit:

```
execute reboot
```

As the FortiGate units starts, a series of system startup messages is displayed.

When one of the following messages appears:

- FortiGate unit running v2.x BIOS
Press Any Key To Download Boot Image.
...
- FortiGate unit running v3.x BIOS
Press any key to enter configuration menu.....
.....

- 7 Immediately press any key to interrupt the system startup.



Note: You have only 3 seconds to press any key. If you do not press a key soon enough, the FortiGate unit reboots and you must log in and repeat the `execute reboot` command.

If you successfully interrupt the startup process, one of the following messages appears:

- FortiGate unit running v2.x BIOS
Enter TFTP Server Address [192.168.1.168]:
Go to step 9.
- FortiGate unit running v3.x BIOS
[G]: Get firmware image from TFTP server.
[F]: Format boot device.
[B]: Boot with backup firmware and set as default.
[Q]: Quit menu and continue to boot with default firmware.
[H]: Display this list of options.

Enter G,F,B,Q, or H:

- 8 Type G to get the new firmware image from the TFTP server.

- 9 Type the address of the TFTP server and press Enter.

The following message appears:

```
Enter Local Address [192.168.1.188]:
```

- 10 Type the address of the internal interface of the FortiGate unit and press Enter.



Note: The local IP address is used only to download the firmware image. After the firmware is installed, the address of this interface is changed back to the default IP address for this interface.

The following message appears:

```
Enter File Name [image.out]:
```

- 11** Enter the firmware image filename and press Enter.
The TFTP server uploads the firmware image file to the FortiGate unit and messages similar to the following are displayed:

- FortiGate unit running v2.x BIOS
Do You Want To Save The Image? [Y/n]
Type Y.
- FortiGate unit running v3.x BIOS
Save as Default firmware/Run image without saving:[D/R]
Save as Default firmware/Backup firmware/Run image without saving:[D/B/R]
Type D.

The FortiGate unit installs the new firmware image and restarts. The installation might take a few minutes to complete.

Restoring the previous configuration

Change the internal interface addresses if required. You can do this from the CLI using the command:

```
set system interface
```

After changing the interface addresses, you can access the FortiGate unit from the web-based manager and restore the configuration.

- To restore the FortiGate unit configuration, see [“Restoring system settings” on page 116](#).
- To restore NIDS user defined signatures, see [“Adding user-defined signatures” on page 274](#).
- To restore web content filtering lists, see [“Restoring the Banned Word list” on page 290](#) and [“Uploading a URL block list” on page 293](#)
- To restore email filtering lists, see [“Uploading the email banned word list” on page 303](#) and [“Uploading an email block list” on page 305](#).

If you are reverting to a previous firmware version (for example, reverting from FortiOS v2.50 to FortiOS v2.36) you might not be able to restore your previous configuration from the backup up configuration file.

Update the virus and attack definitions to the most recent version, see [“Manually initiating antivirus and attack definitions updates” on page 125](#).

Testing a new firmware image before installing it

You can test a new firmware image by installing the firmware image from a system reboot and saving it to system memory. After completing this procedure the FortiGate unit operates using the new firmware image with the current configuration. This new firmware image is not permanently installed. The next time the FortiGate unit restarts, it operates with the originally installed firmware image using the current configuration. If the new firmware image operates successfully, you can install it permanently using the procedure [“Upgrading to a new firmware version” on page 103](#).

To run this procedure you:

- access the CLI by connecting to the FortiGate console port using a null-modem cable,
- install a TFTP server that you can connect to from the FortiGate internal interface. The TFTP server should be on the same subnet as the internal interface.

To test a new firmware image

- 1 Connect to the CLI using a null-modem cable and FortiGate console port.
- 2 Make sure the TFTP server is running.
- 3 Copy the new firmware image file to the root directory of the TFTP server.
- 4 Make sure that the internal interface is connected to the same network as the TFTP server.

You can use the following command to ping the computer running the TFTP server. For example, if the TFTP server's IP address is 192.168.1.168:

```
execute ping 192.168.1.168
```

- 5 Enter the following command to restart the FortiGate unit:

```
execute reboot
```

- 6 As the FortiGate unit reboots, press any key to interrupt the system startup. As the FortiGate units starts, a series of system startup messages are displayed. When one of the following messages appears:

- FortiGate unit running v2.x BIOS
Press Any Key To Download Boot Image.
...
- FortiGate unit running v3.x BIOS
Press any key to enter configuration menu.....
.....

- 7 Immediately press any key to interrupt the system startup.



Note: You have only 3 seconds to press any key. If you do not press a key soon enough, the FortiGate unit reboots and you must log in and repeat the `execute reboot` command.

If you successfully interrupt the startup process, one of the following messages appears:

- FortiGate unit running v2.x BIOS
Enter TFTP Server Address [192.168.1.168]:
Go to step 9.
- FortiGate unit running v3.x BIOS
[G]: Get firmware image from TFTP server.
[F]: Format boot device.
[Q]: Quit menu and continue to boot with default firmware.
[H]: Display this list of options.

Enter G, F, Q, or H:

- 8 Type G to get the new firmware image from the TFTP server.

- 9 Type the address of the TFTP server and press Enter.

The following message appears:

```
Enter Local Address [192.168.1.188]:
```

- 10 Type the address of the internal interface of the FortiGate unit and press Enter.



Note: The local IP address is used only to download the firmware image. After the firmware is installed, the address of this interface is changed back to the default IP address for this interface.

The following message appears:

```
Enter File Name [image.out]:
```

- 11 Enter the firmware image file name and press Enter.

The TFTP server uploads the firmware image file to the FortiGate unit and messages similar to the following appear.

- FortiGate unit running v2.x BIOS

```
Do You Want To Save The Image? [Y/n]
```

Type N.

- FortiGate unit running v3.x BIOS

```
Save as Default firmware/Run image without saving:[D/R]
```

Type R.

The FortiGate image is installed to system memory and the FortiGate unit starts running the new firmware image but with its current configuration.

- 12 You can log into the CLI or the web-based manager using any administrative account.

- 13 To confirm that the new firmware image has been loaded, from the CLI enter:

```
get system status
```

You can test the new firmware image as required.

Installing and using a backup firmware image

If the FortiGate unit is running BIOS version v3.x, you can install a backup firmware image. Once the backup firmware image is installed you can switch to this backup image when required.

This section describes:

- [Installing a backup firmware image](#)
- [Switching to the backup firmware image](#)
- [Switching back to the default firmware image](#)

Installing a backup firmware image

To run this procedure you:

- access the CLI by connecting to the FortiGate console port using a null-modem cable,
- install a TFTP server that you can connect to from the FortiGate as described in the procedure [“Installing firmware images from a system reboot using the CLI” on page 107](#).

To install a backup firmware image

- 1 Connect to the CLI using the null-modem cable and FortiGate console port.
- 2 Make sure that the TFTP server is running.
- 3 Copy the new firmware image file to the root directory of your TFTP server.
- 4 To confirm that the FortiGate unit can connect to the TFTP server, use the following command to ping the computer running the TFTP server. For example, if the IP address of the TFTP server is 192.168.1.168:

```
execute ping 192.168.1.168
```
- 5 Enter the following command to restart the FortiGate unit:

```
execute reboot
```

 As the FortiGate unit starts, a series of system startup messages are displayed. When one of the following messages appears:

```
Press any key to enter configuration menu.....
.....
```
- 6 Immediately press any key to interrupt the system startup.



Note: You have only 3 seconds to press any key. If you do not press a key soon enough, the FortiGate unit reboots and you must log in and repeat the `execute reboot` command.

If you successfully interrupt the startup process, one of the following messages appears:

```
[G]: Get firmware image from TFTP server.
[F]: Format boot device.
[B]: Boot with backup firmware and set as default.
[Q]: Quit menu and continue to boot with default firmware.
[H]: Display this list of options.
```

Enter G, F, B, Q, or H:

- 7 Type G to get the new firmware image from the TFTP server.
- 8 Type the address of the TFTP server and press Enter.
 The following message appears:

```
Enter Local Address [192.168.1.188]:
```
- 9 Type the address of the interface of the FortiGate unit that can connect to the TFTP server and press Enter.
 The following message appears:

```
Enter File Name [image.out]:
```
- 10 Enter the firmware image file name and press Enter.
 The TFTP server uploads the firmware image file to the FortiGate unit and messages similar to the following appear.

```
Save as Default firmware/Backup firmware/Run image without
saving: [D/B/R]
```
- 11 Type B.
 The FortiGate unit saves the backup firmware image and restarts. When the FortiGate unit restarts it is running the previously installed firmware version.

Switching to the backup firmware image

Use this procedure to switch the FortiGate unit to operating with a backup firmware image that you previously installed. When you switch the FortiGate unit to the backup firmware image, the FortiGate unit operates using the configuration that was saved with that firmware image.

If you install a new backup image from a reboot, the configuration saved with this firmware image is the factory default configuration. If you use the procedure [“Switching back to the default firmware image” on page 113](#) to switch to a backup firmware image that was previously running as the default firmware image, the configuration saved with this firmware image is restored.

To switch to the backup firmware image

1 Connect to the CLI using the null-modem cable and FortiGate console port.

2 Enter the following command to restart the FortiGate unit:

```
execute reboot
```

As the FortiGate unit starts, a series of system startup messages are displayed.

When the following message appears:

```
Press any key to enter configuration menu.....  
.....
```

3 Immediately press any key to interrupt the system startup.



Note: You have only 3 seconds to press any key. If you do not press a key soon enough, the FortiGate unit reboots and you must log in and repeat the `execute reboot` command.

If you successfully interrupt the startup process, the following message appears:

```
[G]: Get firmware image from TFTP server.  
[F]: Format boot device.  
[B]: Boot with backup firmware and set as default.  
[Q]: Quit menu and continue to boot with default firmware.  
[H]: Display this list of options.
```

Enter G, F, B, Q, or H:

4 Type B to load the backup firmware image.

The FortiGate unit loads the backup firmware image and restarts. When the FortiGate unit restarts, it is running the backup firmware version and the configuration is set to factory default.

Switching back to the default firmware image

Use this procedure to switch the FortiGate unit to operating with the backup firmware image that had been running as the default firmware image. When you switch to this backup firmware image, the configuration saved with this firmware image is restored.

To switch back to the default firmware image

1 Connect to the CLI using the null-modem cable and FortiGate console port.

2 Enter the following command to restart the FortiGate unit:

```
execute reboot
```

As the FortiGate unit starts, a series of system startup messages are displayed.

When the following message appears:

```
Press any key to enter configuration menu.....
.....
```

3 Immediately press any key to interrupt the system startup.



Note: You have only 3 seconds to press any key. If you do not press a key soon enough, the FortiGate unit reboots and you must log in and repeat the `execute reboot` command.

If you successfully interrupt the startup process, the following message appears:

```
[G]: Get firmware image from TFTP server.
[F]: Format boot device.
[B]: Boot with backup firmware and set as default.
[Q]: Quit menu and continue to boot with default firmware.
[H]: Display this list of options.
```

Enter G, F, B, Q, or H:

4 Type B to load the backup firmware image.

The FortiGate unit loads the backup firmware image and restarts. When the FortiGate unit restarts it is running the backup firmware version with a restored configuration.

Manual virus definition updates

The Status page of the FortiGate web-based manager displays the current installed versions of the FortiGate antivirus definitions.



Note: For information about configuring the FortiGate unit for automatic antivirus definitions updates, see [“Virus and attack definitions updates and registration”](#) on page 123. You can also manually start an antivirus definitions update by going to **System > Update** and selecting Update Now.

To update the antivirus definitions manually

1 Download the latest antivirus definitions update file from Fortinet and copy it to the computer that you use to connect to the web-based manager.

2 Start the web-based manager and go to **System > Status**.

3 In the Antivirus Definitions Version section, select Definitions Update .

4 Type the path and filename for the antivirus definitions update file, or select Browse and locate the antivirus definitions update file.

5 Select OK to copy the antivirus definitions update file to the FortiGate unit. The FortiGate unit updates the antivirus definitions. This takes about 1 minute.

6 Go to **System > Status** to confirm that the Antivirus Definitions Version information has updated.

Manual attack definition updates

The Status page of the FortiGate web-based manager displays the current installed versions of the FortiGate Attack Definitions used by the Network Intrusion Detection System (NIDS).



Note: For information about configuring the FortiGate unit for automatic attack definitions updates, see [“Virus and attack definitions updates and registration”](#) on page 123. You can also manually start an attack definitions update by going to **System > Update** and selecting Update Now.

To update the attack definitions manually

- 1 Download the latest attack definitions update file from Fortinet and copy it to the computer that you use to connect to the web-based manager.
- 2 Start the web-based manager and go to **System > Status**.
- 3 In the Attack Definitions Version section, select Definitions Update .
- 4 Type the path and filename for the attack definitions update file, or select Browse and locate the attack definitions update file.
- 5 Select OK to copy the attack definitions update file to the FortiGate unit. The FortiGate unit updates the attack definitions. This takes about 1 minute.
- 6 Go to **System > Status** to confirm that the Attack Definitions Version information has updated.

Displaying the FortiGate serial number

- 1 Go to **System > Status**.
The serial number is displayed on the System Status page of the web-based manager. The serial number is specific to the FortiGate unit and does not change with firmware upgrades.

Displaying the FortiGate up time

- 1 Go to **System > Status**.
The FortiGate up time displays the time in days, hours, and minutes since the FortiGate unit was last started.

Backing up system settings

You can back up system settings by downloading them to a text file on the management computer.

To back up system settings

- 1 Go to **System > Status**.
- 2 Select System Settings Backup.
- 3 Select Backup System Settings.
- 4 Type a name and location for the file.
The system settings file is backed up to the management computer.
- 5 Select Return to go back to the Status page.

Restoring system settings

You can restore system settings by uploading a previously downloaded system settings text file.

To restore system settings

- 1 Go to **System > Status**.
- 2 Select System Settings Restore.
- 3 Enter the path and filename of the system settings file, or select Browse and locate the file.
- 4 Select OK to restore the system settings file to the FortiGate unit.
The FortiGate unit restarts, loading the new system settings.
- 5 Reconnect to the web-based manager and review your configuration to confirm that the uploaded system settings have taken effect.

Restoring system settings to factory defaults

Use the following procedure to restore system settings to the values set at the factory. This procedure does not change the firmware version or the antivirus or attack definitions.



Caution: This procedure deletes all changes that you have made to the FortiGate configuration and reverts the system to its original configuration, including resetting interface addresses.

To restore system settings to factory defaults

- 1 Go to **System > Status**.
- 2 Select Restore Factory Defaults.
- 3 Select OK to confirm.
The FortiGate unit restarts with the configuration that it had when it was first powered on.
- 4 Reconnect to the web-based manager and review the system configuration to confirm that it has been reset to the default settings.

For information about restoring system settings, see [“Restoring system settings” on page 116](#).

Changing to Transparent mode

Use the following procedure to change the FortiGate unit from NAT/Route mode to Transparent mode. After you change the FortiGate unit to Transparent mode, most of the configuration resets to Transparent mode factory defaults.

The following items are not set to Transparent mode factory defaults:

- The admin administrator account password (see [“Adding and editing administrator accounts” on page 178](#))
- HA settings (see [“High availability” on page 81](#))
- Custom replacement messages (see [“Replacement messages” on page 187](#))

To change to Transparent mode

- 1 Go to **System > Status**.
- 2 Select Change to Transparent Mode.
- 3 Select Transparent in the operation mode list.
- 4 Select OK.
The FortiGate unit changes operation mode.
- 5 To reconnect to the web-based manager, connect to the interface configured for Transparent mode management access and browse to https:// followed by the Transparent mode management IP address.
By default in Transparent mode, you can connect to the internal interface. The default Transparent mode management IP address is 10.10.10.1.

Changing to NAT/Route mode

Use the following procedure to change the FortiGate unit from Transparent mode to NAT/Route mode. After you change the FortiGate unit to NAT/Route mode, most of the configuration resets to NAT/Route mode factory defaults.

The following items are not set to NAT/Route mode factory defaults:

- The admin administrator account password (see [“Adding and editing administrator accounts” on page 178](#))
- HA settings (see [“High availability” on page 81](#))
- Custom replacement messages (see [“Replacement messages” on page 187](#))

To change to NAT/Route mode

- 1 Go to **System > Status**.
- 2 Select Change to NAT Mode.
- 3 Select NAT/Route in the operation mode list.

- 4 Select OK.
The FortiGate unit changes operation mode.
- 5 To reconnect to the web-based manager you must connect to the interface configured by default for management access.
By default in NAT/Route mode, you can connect to the internal interface. The default Transparent mode management IP address is 192.168.1.99.
See [“Connecting to the web-based manager” on page 44](#) or [“Connecting to the Command Line Interface \(CLI\)” on page 47](#).

Restarting the FortiGate unit

- 1 Go to **System > Status**.
- 2 Select Restart.
The FortiGate unit restarts.

Shutting down the FortiGate unit

You can restart the FortiGate unit after shutdown only by turning the power off and then on.

- 1 Go to **System > Status**.
- 2 Select Shutdown.
The FortiGate unit shuts down and all traffic flow stops.

System status

You can use the system status monitor to display FortiGate system health information. The system health information includes memory usage, the number of active communication sessions, and the amount of network bandwidth currently in use. The web-based manager displays current statistics as well as statistics for the previous minute.

If the FortiGate unit contains a hard disk, the system status monitor displays the capacity of the hard disk and the amount of used and free space on the hard disk.

You can also view current virus and intrusion status. The web-based manager displays the current number of viruses and attacks as well as a graph of virus and attack levels over the previous 20 hours.

In each case you can set an automatic refresh interval that updates the display every 5 to 30 seconds. You can also refresh the display manually.

- [Viewing CPU and memory status](#)
- [Viewing sessions and network status](#)
- [Viewing virus and intrusions status](#)

Viewing CPU and memory status

Current CPU and memory status indicates how close the FortiGate unit is to running at full capacity. The web-based manager displays CPU and memory usage for core processes only. CPU and memory use for management processes (for example, for HTTPS connections to the web-based manager) is excluded.

If CPU and memory use is low, the FortiGate unit is able to process much more network traffic than is currently running. If CPU and memory use is high, the FortiGate unit is performing near its full capacity. Putting additional demands on the system might cause traffic processing delays.

CPU and memory intensive processes, such as encrypting and decrypting IPsec VPN traffic, virus scanning, and processing high levels of network traffic containing small packets, increase CPU and memory usage.

To view CPU and memory status

- 1 Go to **System > Status > Monitor**.
CPU & Memory status is displayed. The display includes bar graphs of current CPU and memory usage as well as line graphs of CPU and memory usage for the previous minute.
If your FortiGate unit contains a hard disk, CPU, memory, and hard disk status are displayed.
- 2 Set the automatic refresh interval and select Go to control how often the web-based manager updates the display.
More frequent updates use system resources and increase network traffic. However, this occurs only when you are viewing the display using the web-based manager.
- 3 Select Refresh to manually update the information displayed.

Figure 32: CPU and memory status monitor

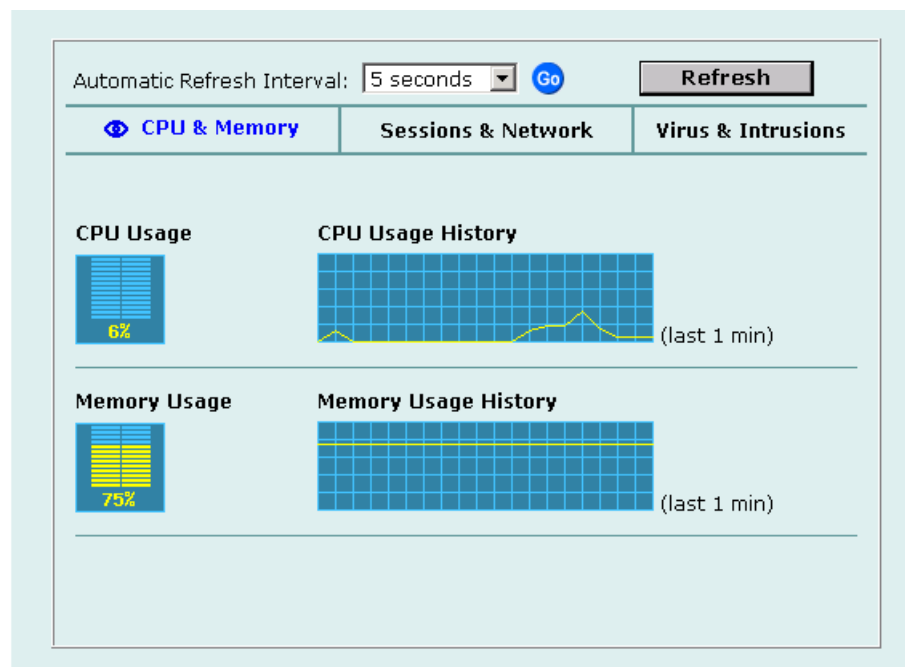

Viewing sessions and network status

Use the session and network status display to track how many network sessions the FortiGate unit is processing and to see what effect the number of sessions has on the available network bandwidth. Also, by comparing CPU and memory usage with session and network status you can see how much demand network traffic is putting on system resources.

The Sessions section displays the total number of sessions being processed by the FortiGate unit on all interfaces. It also displays the sessions as a percentage of the maximum number of sessions that the FortiGate unit is designed to support.

The Network utilization section displays the total network bandwidth being used through all FortiGate interfaces. It also displays network utilization as a percentage of the maximum network bandwidth that can be processed by the FortiGate unit.

To view sessions and network status

- 1 Go to **System > Status > Monitor**.
- 2 Select Sessions & Network.
Sessions and network status is displayed. The display includes bar graphs of the current number of sessions and current network utilization as well as line graphs of session and network utilization usage for the last minute. The line graph scales are shown in the upper left corner of the graph.
- 3 Set the automatic refresh interval and select Go to control how often the web-based manager updates the display.
More frequent updates use system resources and increase network traffic. However, this only occurs when you are viewing the display using the web-based manager.
- 4 Select Refresh to manually update the information displayed.

Figure 33: Sessions and network status monitor

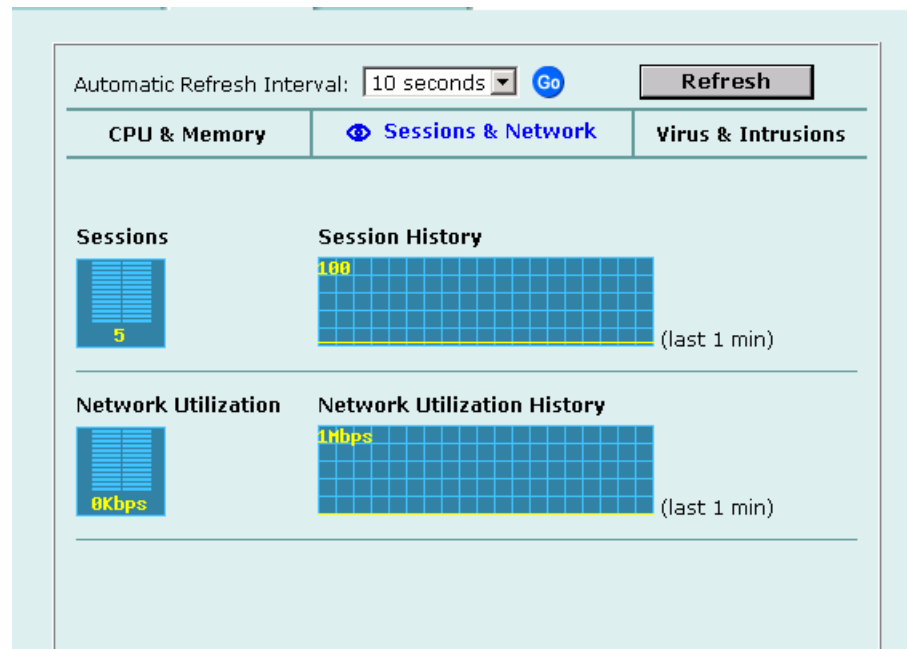

Viewing virus and intrusions status

Use the virus and intrusions status display to track when viruses are found by the FortiGate antivirus system and to track when the NIDS detects a network-based attack.

To view virus and intrusions status

- 1 Go to **System > Status > Monitor**.
- 2 Select Virus & Intrusions.
Virus and intrusions status is displayed. The display includes bar graphs of the number viruses and intrusions detected per hour as well as line graphs of the number of viruses and intrusions detected for the last 20 hours.
- 3 Set the automatic refresh interval and select Go to control how often the web-based manager updates the display.
More frequent updates use system resources and increase network traffic. However, this only occurs when you are viewing the display using the web-based manager. The line graph scales are shown on the upper right corner of the graph.
- 4 Select Refresh to manually update the information displayed.



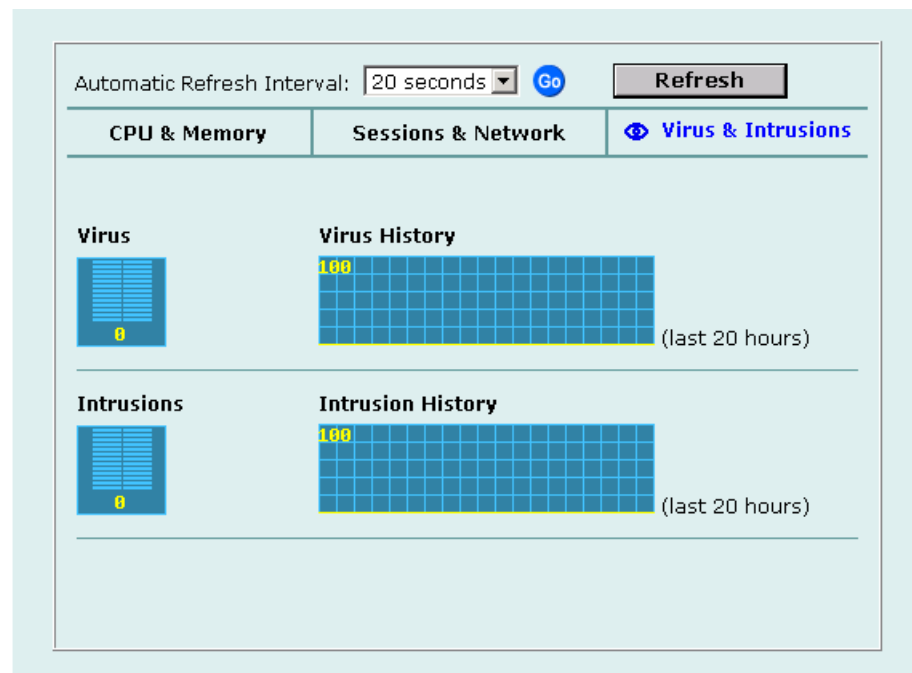

Figure 34: Sessions and network status monitor



Session list

The session list displays information about the communications sessions currently being processed by the FortiGate unit. You can use the session list to view current sessions. FortiGate administrators with read and write permission and the FortiGate admin user can also stop active communication sessions.





















To view the session list

- 1 Go to **System > Status > Session**.
The web-based manager displays the total number of active sessions in the FortiGate unit session table and lists the top 16.
- 2 To navigate the list of sessions, select Page Up  or Page Down .
- 3 Select Refresh  to update the session list.
- 4 If you are logged in as an administrative user with read and write privileges or as the admin user, you can select Clear  to stop an active session.

Each line of the session list displays the following information.

- Protocol** The service protocol of the connection, for example, udp, tcp, or icmp.
- From IP** The source IP address of the connection.
- From Port** The source port of the connection.
- To IP** The destination IP address of the connection.
- To Port** The destination port of the connection.
- Expire** The time, in seconds, before the connection expires.
- Clear** Stop an active communication session.

Figure 35: Example session list

Total Number of Sessions: 659   						
Protocol	From IP	From Port	To IP	To Port	Expire (secs)	Clear 
udp	192.168.110.200	1242	206.191.0.210	53	76	
tcp	192.168.110.121	4704	192.168.110.3	443	8	
tcp	192.168.110.200	1250	65.39.139.188	110	42	
tcp	192.168.110.121	4699	192.168.110.3	443	8	
tcp	192.168.110.121	4691	192.168.110.3	443	56	
tcp	192.168.110.121	4479	10.0.1.128	6969	72	
udp	192.168.110.200	1246	209.87.239.20	53	86	
udp	192.168.110.200	1246	209.87.239.21	53	89	
tcp	192.168.110.121	4674	192.168.110.3	443	8	
tcp	192.168.110.155	1107	65.39.139.188	143	3262	
tcp	192.168.110.200	1248	65.39.139.188	110	30	
tcp	192.168.110.123	2307	65.39.139.188	110	26	
tcp	192.168.110.121	4701	192.168.110.3	443	8	
tcp	192.168.110.154	1117	65.39.139.188	143	962	
tcp	192.168.110.121	4361	10.0.1.128	6969	49	
tcp	192.168.110.123	2308	65.39.139.188	110	85	
tcp	192.168.110.121	4708	192.168.110.3	443	58	

Virus and attack definitions updates and registration

You can configure the FortiGate unit to connect to the FortiResponse Distribution Network (FDN) to update the antivirus and attack definitions and the antivirus engine. You have the following update options:

- Request updates from the FDN,
- Schedule updates to automatically request the latest versions hourly, daily, or weekly,
- Set Push updates so that the FDN contacts your FortiGate unit when a new update is available.

To receive scheduled updates and push updates, you must register the FortiGate unit on the Fortinet support web page.

This chapter describes:

- [Updating antivirus and attack definitions](#)
- [Scheduling updates](#)
- [Enabling push updates](#)
- [Registering FortiGate units](#)
- [Updating registration information](#)
- [Registering a FortiGate unit after an RMA](#)

Updating antivirus and attack definitions

You can configure the FortiGate unit to connect to the FortiResponse Distribution Network (FDN) to automatically receive the latest antivirus and attack definitions and antivirus engine updates. The FortiGate unit supports the following antivirus and attack definition update features:

- User-initiated updates from the FDN,
- Hourly, daily, or weekly scheduled antivirus and attack definition and antivirus engine updates from the FDN,
- Push updates from the FDN,
- Update status including version numbers, expiry dates, and update dates and times,
- Push updates through a NAT device.

The Update page on the web-based manager displays the following antivirus and attack definition update information.

Version	Current antivirus engine, virus definition, and attack definition version numbers.
Expiry date	Expiry date of your license for antivirus engine, virus definition, and attack definition updates.
Last update attempt	Date and time on which the FortiGate unit last attempted to download antivirus engine, virus definition, and attack definition updates.
Last update status	Success or failure of the last update attempt. No updates means the last update attempt was successful but no new updates were available. Update succeeded or similar messages mean the last update attempt was successful and new updates were installed. Other messages can indicate that the FortiGate was not able to connect to the FDN and other error conditions.

This section describes:

- [Connecting to the FortiResponse Distribution Network](#)
- [Manually initiating antivirus and attack definitions updates](#)
- [Configuring update logging](#)

Connecting to the FortiResponse Distribution Network

Before the FortiGate unit can receive antivirus and attack updates, it must be able to connect to the FortiResponse Distribution Network (FDN). The FortiGate unit uses HTTPS on port 8890 to connect to the FDN. The FortiGate external interface must have a path to the Internet using port 8890. For information about configuring scheduled updates, see [“Scheduling updates” on page 126](#).

You can also configure the FortiGate unit to allow push updates. Push updates are provided to the FortiGate unit from the FDN using HTTPS on UDP port 9443. To receive push updates, the FDN must have a path to the FortiGate external interface using UDP port 9443. For information about configuring push updates, see [“Enabling push updates” on page 128](#).

The FDN is a world-wide network of FortiResponse Distribution Servers (FDSs). When the FortiGate unit connects to the FDN it connects to the nearest FDS. To do this, all FortiGate units are programmed with a list of FDS addresses sorted by nearest time zone according to the time zone configured for the FortiGate unit. To make sure the FortiGate unit receives updates from the nearest FDS, check that you have selected the correct time zone for your area.

To make sure the FortiGate unit can connect to the FDN

- 1 Go to **System > Config > Time** and make sure the time zone is set to the time zone for the region in which your FortiGate unit is located.
- 2 Go to **System > Update**.
- 3 Select Refresh.

The FortiGate unit tests its connection to the FDN. The test results are displayed at the top of the System Update page.

Table 27: Connections to the FDN

Connections	Status	Comments
FortiResponse Distribution Network	Available	The FortiGate unit can connect to the FDN. You can configure the FortiGate unit for scheduled updates. See “Scheduling updates” on page 126 .
	Not available	The FortiGate unit cannot connect to the FDN. You must configure your FortiGate unit and your network so that the FortiGate unit can connect to the Internet and to the FDN. For example, you may need to add routes to the FortiGate routing table or configure your network to allow the FortiGate unit to use HTTPS on port 8890 to connect to the Internet. You may also have to connect to an override FortiResponse server to receive updates. See “Adding an override server” on page 127 .
Push Update	Available	The FDN can connect to the FortiGate unit to send push updates. You can configure the FortiGate unit to receive push updates. See “Enabling push updates” on page 128 .
	Not available	The FDN cannot connect to the FortiGate unit to send push updates. Push updates may not be available if you have not registered the FortiGate unit (see “Registering the FortiGate unit” on page 134), if there is a NAT device installed between the FortiGate unit and the FDN (see “Enabling push updates through a NAT device” on page 129), or if your FortiGate unit connects to the Internet using a proxy server (see “Enabling scheduled updates through a proxy server” on page 128).

Manually initiating antivirus and attack definitions updates

You can use the following procedure to update the antivirus and attack definitions at any time. The FortiGate unit must be able to connect to the FDN or to an override FortiResponse server.

To update antivirus and attack definitions

- 1 Go to **System > Update**.
- 2 Select Update Now to update the antivirus and attack definitions.

If the connection to the FDN or override server is successful, the web-based manager displays a message similar to the following:

```
Your update request has been sent. Your database will be updated
in a few minutes. Please check your update page for the status
of the update.
```

After a few minutes, if an update is available, the System Update page lists new version information for antivirus definitions, the antivirus engine, or attack definitions. The System Status page also displays new dates and version numbers for antivirus and attack definitions. Messages are recorded to the event log indicating whether the update was successful or not.

Configuring update logging

Use the following procedure to configure FortiGate logging to record log messages when the FortiGate unit updates antivirus and attack definitions. The update log messages are recorded on the FortiGate Event log.

To configure update logging

- 1 Go to **Log&Report > Log Setting**.
- 2 Select Config Policy for the type of logs that the FortiGate unit is configured to record. For information about recording logs, see [“Recording logs” on page 307](#).
- 3 Select Update to record log messages when the FortiGate unit updates antivirus and attack definitions.
- 4 Select any of the following update log options.

Failed Update	Records a log message whenever an update attempt fails.
Successful Update	Records a log message whenever an update attempt is successful.
FDN error	Records a log message whenever it cannot connect to the FDN or whenever it receives an error message from the FDN.
- 5 Select OK.

Scheduling updates

The FortiGate unit can check for and download updated definitions hourly, daily, or weekly, according to a schedule that you specify.

This section describes:

- [Enabling scheduled updates](#)
- [Adding an override server](#)
- [Enabling scheduled updates through a proxy server](#)

Enabling scheduled updates

To enable scheduled updates

- 1 Go to **System > Update**.
- 2 Select the Scheduled Update check box.
- 3 Select one of the following to check for and download updates.

Hourly	Once every 1 to 23 hours. Select the number of hours and minutes between each update request.
Daily	Once a day. You can specify the time of day to check for updates.
Weekly	Once a week. You can specify the day of the week and the time of day to check for updates.

4 Select Apply.

The FortiGate unit starts the next scheduled update according to the new update schedule.

Whenever the FortiGate unit runs a scheduled update, the event is recorded in the FortiGate event log.

Figure 36: Configuring automatic antivirus and attack definitions updates

Update Support

FortiResponse Distribution Network available Refresh

Push Update not available

Use override server address

Update	Version	Expiry date	Last update attempt	Last Update Status
Anti Virus Engine	1.00	Mon Nov 29 19:00:00 1999	Tue Aug 12 14:25:21 2003	No updates
Anti Virus Definition	4.115	Mon Nov 29 19:00:00 1999	Tue Aug 12 14:25:21 2003	No updates
Attack Definition	2.56	Mon Nov 29 19:00:00 1999	Tue Aug 12 14:25:21 2003	No updates

Allow Push Update

Use override push IP Port

Scheduled Update

Every (hour) (minutes after the hour)

Daily: (hour) (minute)

Weekly: (day) (hour) (minute)

Adding an override server

If you cannot connect to the FDN, or if your organization provides antivirus and attack updates using their own FortiResponse server, you can use the following procedure to add the IP address of an override FortiResponse server.

To add an override server

- 1** Go to **System > Update**.
- 2** Select the Use override server address check box.
- 3** Type the IP address of a FortiResponse server.
- 4** Select Apply.

The FortiGate unit tests the connection to the override server.

If the FortiResponse Distribution Network setting changes to available, the FortiGate unit has successfully connected to the override server.

If the FortiResponse Distribution Network stays set to not available, the FortiGate unit cannot connect to the override server. Check the FortiGate configuration and network configuration for settings that would prevent the FortiGate unit connecting to the override FortiResponse server.

Enabling scheduled updates through a proxy server

If your FortiGate unit must connect to the Internet through a proxy server, you can use the `set system autoupdate tunneling` command to allow the FortiGate unit to connect (or tunnel) to the FDN using the proxy server. Using this command you can specify the IP address and port of the proxy server. As well, if the proxy server requires authentication, you can add the user name and password required for the proxy server to the autoupdate configuration. The full syntax for enabling updates through a proxy server is:

```
set system autoupdate tunneling enable [address  
<proxy-address_ip> [port <proxy-port> [username <username_str>  
[password <password_str>]]]]
```

For example, if the IP address of the proxy server is 64.23.6.89 and its port is 8080, enter the following command:

```
set system autoupdate tunneling enable address 64.23.6.89  
port 8080
```

For more information about the `set system autoupdate` command, see *Volume 6, FortiGate CLI Reference Guide*.

The FortiGate unit connects to the proxy server using the HTTP CONNECT method, as described in RFC 2616. The FortiGate unit sends an HTTP CONNECT request to the proxy server (optionally with authentication information) specifying the IP address and port required to connect to the FDN. The proxy server establishes the connection to the FDN and passes information between the FortiGate unit and the FDN.

The CONNECT method is used mostly for tunneling SSL traffic. Some proxy servers do not allow the CONNECT to connect to any port; they restrict the allowed ports to the well known ports for HTTPS and perhaps some other similar services. Because FortiGate autoupdates use HTTPS on port 8890 to connect to the FDN, your proxy server might have to be configured to allow connections on this port.

There are no special tunneling requirements if you have configured an override server address to connect to the FDN.

Enabling push updates

The FDN can push updates to FortiGate units to provide the fastest possible response to critical situations. You must register the FortiGate unit before it can receive push updates. See [“Registering the FortiGate unit” on page 134](#).

When you configure a FortiGate unit to allow push updates, the FortiGate unit sends a SETUP message to the FDN. The next time a new antivirus engine, new antivirus definitions, or new attack definitions are released, the FDN notifies all FortiGate units that are configured for push updates that a new update is available. Within 60 seconds of receiving a push notification, the FortiGate unit requests an update from the FDN.



Note: Push updates are not supported if the FortiGate unit must use a proxy server to connect to the FDN. For more information, see [“Enabling scheduled updates through a proxy server” on page 128](#).

When the network configuration permits, configuring push updates is recommended in addition to configuring scheduled updates. On average the FortiGate unit receives new updates sooner through push updates than if the FortiGate unit receives only scheduled updates. However, scheduled updates make sure that the FortiGate unit receives the latest updates.

Enabling push updates is not recommended as the only method for obtaining updates. The FortiGate unit might not receive the push notification. Also, when the FortiGate unit receives a push notification it makes only one attempt to connect to the FDN and download updates.

This section describes:

- [Enabling push updates](#)
- [Push updates when FortiGate IP addresses change](#)
- [Enabling push updates through a NAT device](#)

Enabling push updates

To enable push updates

- 1 Go to **System > Update**.
- 2 Select Allow Push Update.
- 3 Select Apply.

Push updates when FortiGate IP addresses change

The SETUP message that the FortiGate unit sends when you enable push updates includes the IP address of the FortiGate interface that the FDN connects to. If your FortiGate unit is running in NAT/Route mode, the SETUP message includes the FortiGate external IP address. If your FortiGate unit is running in Transparent mode, the SETUP message includes the FortiGate management IP address. The FDN must be able to connect to this IP address for your FortiGate unit to be able to receive push update messages. If your FortiGate unit is behind a NAT device, see [“Enabling push updates through a NAT device” on page 129](#).

Whenever the external IP address of the FortiGate unit changes, the FortiGate unit sends a new SETUP message to notify the FDN of the address change. As long as the FortiGate unit sends this SETUP message and the FDN receives it, the FDN can maintain the most up-to-date external IP address for the FortiGate unit.

The FortiGate unit sends the SETUP message if you change the external IP address manually or if you have set the external interface addressing mode to DHCP or PPPoE and your DHCP or PPPoE server changes the IP address.

In Transparent mode if you change the management IP address, the FortiGate unit also sends the SETUP message to notify the FDN of the address change.

Enabling push updates through a NAT device

If the FDN can connect to the FortiGate unit only through a NAT device, you must configure port forwarding on the NAT device and add the port forwarding information to the push update configuration. Using port forwarding, the FDN connects to the FortiGate unit using either port 9443 or an override push port that you specify.

General procedure

Use the following steps to configure the FortiGate NAT device and the FortiGate unit on the internal network so that the FortiGate unit on the internal network can receive push updates:

- 1 Add a port forwarding virtual IP to the FortiGate NAT device.
- 2 Add a firewall policy to the FortiGate NAT device that includes the port forwarding virtual IP.
- 3 Configure the FortiGate unit on the internal network with an override push IP and port.



Note: Before completing the following procedure, you should register the internal network FortiGate unit so that it can receive push updates.

Adding a port forwarding virtual IP to the FortiGate NAT device

Use the following procedure to configure a FortiGate NAT device to use port forwarding to forward push update connections from the FDN to a FortiGate unit on the internal network.

To configure the FortiGate NAT device

- 1 Go to **Firewall > Virtual IP**.
- 2 Select **New**.
- 3 Type a name for the virtual IP.
- 4 In the **External Interface** section, select the external interface that the FDN connects to.
For the example topology, select the external interface.
- 5 In the **Type** section, select **Port Forwarding**.
- 6 In the **External IP Address** section, type the external IP address that the FDN connects to.
For the example topology, enter 64.230.123.149.
- 7 Type the **External Service Port** that the FDN connects to.
For the example topology, enter 45001.
- 8 In the **Map to IP** section, type the IP address of the FortiGate unit on the internal network.
If the FortiGate unit is operating in NAT/Route mode, enter the IP address of the external interface.
If the FortiGate unit is operating in Transparent mode, enter the management IP address.
For the example topology, enter 192.168.1.99.
- 9 Set the **Map to Port** to 9443.
- 10 Set **Protocol** to **UDP**.
- 11 Select **OK**.

Figure 38: Push update port forwarding virtual IP

Adding a firewall policy for the port forwarding virtual IP

Figure 38: Push update port forwarding virtual IP

- 4 Set IP to the external IP address added to the virtual IP.
For the example topology, enter 64.230.123.149.
- 5 Set Port to the external service port added to the virtual IP.
For the example topology, enter 45001.
- 6 Select Apply.
The FortiGate unit sends the override push IP address and port to the FDN. The FDN now uses this IP address and port for push updates to the FortiGate unit on the internal network.
If the external IP address or external service port change, add the changes to the Use override push configuration and select Apply to update the push information on the FDN.

Figure 39: Example push update configuration

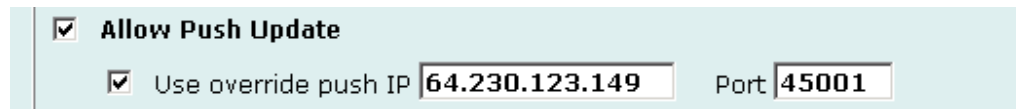

Allow Push Update

Use override push IP Port

- 7 Select Apply.
- 8 You can select Refresh to make sure that push updates work.
Push Update changes to Available.

Registering FortiGate units

After purchasing and installing a new FortiGate unit, you can register the unit using the web-based manager by going to System Update Support page, or by using a web browser to connect to <http://support.fortinet.com> and selecting Product Registration.

Registration consists of entering your contact information and the serial numbers of the FortiGate units that you or your organization purchased. You can register multiple FortiGate units in a single session without re-entering your contact information.

Once registration is completed, Fortinet sends a Support Login user name and password to your email address. You can use this user name and password to log on to the Fortinet support web site to:

- View your list of registered FortiGate units
- Register additional FortiGate units
- Add or change FortiCare Support Contract numbers for each FortiGate unit
- View and change registration information
- Download virus and attack definitions updates
- Download firmware upgrades
- Modify registration information after an RMA

Soon you will also be able to:

- Access Fortinet user documentation
- Access the Fortinet knowledge base

All registration information is stored in the Fortinet Customer Support database. This information is used to make sure that your registered FortiGate units can be kept up to date. All information is strictly confidential. Fortinet does not share this information with any third-party organizations for any reason.

This section describes:

- [FortiCare Service Contracts](#)
- [Registering the FortiGate unit](#)

FortiCare Service Contracts

Owners of a new FortiGate unit are entitled to 90 days of technical support services. To continue receiving support services after the 90-day expiry date, you must purchase a FortiCare Support Contract from an authorized Fortinet reseller or distributor. Different levels of service are available so you can purchase the support that you need. For maximum network protection, Fortinet strongly recommends that all customers purchase a service contract that covers antivirus and attack definition updates. See your Fortinet reseller or distributor for details of packages and pricing.

To activate the FortiCare Support Contract, you must register the FortiGate unit and add the FortiCare Support Contract number to the registration information. You can also register the FortiGate unit without purchasing a FortiCare Support Contract. In that case, when you purchase a FortiCare Support Contract you can update the registration information to add the support contract number.

A single FortiCare Support Contract can cover multiple FortiGate units. You must enter the same service contract number for each of the FortiGate models covered by the service contract.

Registering the FortiGate unit

Before registering a FortiGate unit, you require the following information:

- Your contact information including:
 - First and last name
 - Company name
 - Email address (Your Fortinet support login user name and password will be sent to this email address.)
 - Address
 - Contact phone number
- A security question and an answer to the security question.

This information is used for password recovery. The security question should be a simple question that only you know the answer to. The answer should not be easy to guess.

- The product model and serial number for each FortiGate unit that you want to register.
The serial number is located on a label on the bottom of the FortiGate unit. You can view the Serial number from the web-based manager by going to System > Status.
The serial number is also available from the CLI using the `get system status` command.
- FortiCare Support Contract numbers, if you purchased FortiCare Support Contracts for the FortiGate units that you want to register.

To register one or more FortiGate units

- 1 Go to **System > Update > Support**.
- 2 Enter your contact information on the product registration form.

Figure 40: Registering a FortiGate unit (contact information and security question)

Contact Information			
First Name *	Customer	Last Name *	Name
Company *	Company	Title	Administrator
Email *	Customer@company.com		
Address 1 *	123 My Street		
Address 2			
City *	City	State/Province *	State
Zip *	123456	Country/Region *	UNITED STATES
Contact Phone *	1-555-555-5555	Fax Number	
Security Question *	Security question (will be used if you forgot your password)		
Answer to Security Question *	***** (will be used if you forgot your password)		

- 3 Provide a security question and an answer to the security question.
- 4 Select the model number of the Product Model to register.
- 5 Enter the Serial Number of the FortiGate unit.
- 6 If you have purchased a FortiCare Support Contract for this FortiGate unit, enter the support contract number.

Figure 41: Registering a FortiGate unit (product information)

Product Information	
Product Model *	FGT-60
Serial Number *	FGT-60280303002 (Located on bottom of unit and also on "System" screen on the web user interface)
Support Contract No.	334278334744

* - indicates Required Fields

7 Select Finish.

If you have not entered a FortiCare Support Contract number (SCN) you can return to the previous page to enter the number. If you do not have a FortiCare Support Contract, you can select Continue to complete the registration.

If you have entered a support contract number, a real-time validation is performed to verify that the SCN information matches the FortiGate unit. If the information does not match you can try entering it again.

A web page is displayed that contains detailed information about the Fortinet technical support services available to you for the registered FortiGate unit.

Your Fortinet support user name and password is sent to the email address provided with your contact information.

Updating registration information

You can use your Fortinet support user name and password to log on to the Fortinet Support web site at any time to view or update your Fortinet support information.

This section describes:

- [Recovering a lost Fortinet support password](#)
- [Viewing the list of registered FortiGate units](#)
- [Registering a new FortiGate unit](#)
- [Adding or changing a FortiCare Support Contract number](#)
- [Changing your Fortinet support password](#)
- [Changing your contact information or security question](#)
- [Downloading virus and attack definitions updates](#)

Recovering a lost Fortinet support password

If you provided a security question and answer when you registered on the Fortinet support web site, you can use the following procedure to receive a replacement password. If you did not provide a security question and answer, contact Fortinet technical support.

To recover a lost Fortinet support password

- 1** Go to **System > Update > Support**.
- 2** Select Support Login.
- 3** Enter your Fortinet support user name.
- 4** Select Forgot your password?
- 5** Enter your email address and select Submit.
The security question that you entered when you registered is displayed.
- 6** Enter the answer to your security question and select Get Password.
If you entered the correct answer to the security question, an email containing a new password is sent to your email address. You can use your current user name and this password to log into the Fortinet support web site.

- 7 Select Support Login.
- 8 When you receive your new password, enter your user name and new password to log into the Fortinet support web site.

Viewing the list of registered FortiGate units

To view the list of registered FortiGate units

- 1 Go to **System > Update > Support**.
- 2 Select Support Login.
- 3 Enter your Fortinet support user name and password.
- 4 Select Login.
- 5 Select View Products.

The list of FortiGate products that you have registered is displayed. For each FortiGate unit, the list includes the serial number and current support options for that unit.

Figure 42: Sample list of registered FortiGate units

View Product Support			
Serial Number FGT-602803030020			
Support Type	Hours	Activation Date	Expiration Date
Hardware Coverage	--	5/12/2003	5/11/2004
Firmware Updates	--	5/12/2003	8/10/2003
Telephone Support	8x5	5/12/2003	8/10/2003
Virus Definitions Updates	--	5/12/2003	8/10/2003
Attack Definitions Updates	--	5/12/2003	8/10/2003
Serial Number FGT1002801021024			
Support Type	Hours	Activation Date	Expiration Date
Hardware Coverage	--	5/7/2003	5/6/2004
Firmware Updates	--	5/7/2003	8/5/2003
Telephone Support	8x5	5/7/2003	8/5/2003
Virus Definitions Updates	--	5/7/2003	8/5/2003
Attack Definitions Updates	--	5/7/2003	8/5/2003

Registering a new FortiGate unit

To register a new FortiGate unit

- 1 Go to **System > Update > Support**.
- 2 Select Support Login.
- 3 Enter your Fortinet support user name and password.
- 4 Select Login.
- 5 Select Add Registration.
- 6 Select the model number of the product model that you want to register.

- 7 Enter the serial number of the FortiGate unit.
- 8 If you have purchased a FortiCare Support Contract for this FortiGate unit, enter the support contract number.
- 9 Select Finish.
The list of FortiGate products that you have registered is displayed. The list now includes the new FortiGate unit.

Adding or changing a FortiCare Support Contract number

To add or change a FortiCare Support Contract number

- 1 Go to **System > Update > Support**.
- 2 Select Support Login.
- 3 Enter your Fortinet support user name and password.
- 4 Select Login.
- 5 Select Add/Change Contract number.
- 6 Select the Serial Number of the FortiGate unit for which to add or change a FortiCare Support Contract number.
- 7 Add the new Support Contract number.
- 8 Select Finish.
The list of FortiGate products that you have registered is displayed. The list now includes the new support contract information.

Changing your Fortinet support password

To change your Fortinet support password

- 1 Go to **System > Update > Support**.
- 2 Select Support Login.
- 3 Enter your Fortinet support user name and password.
- 4 Select Login.
- 5 Select My Profile.
- 6 Select Change Password.
- 7 Enter your current password.
- 8 Enter and confirm a new password.
An email is sent to your email address confirming that your password has been changed. Use your current user name and new password the next time you log into the Fortinet technical support web site.

Changing your contact information or security question

To change your contact information or security question

- 1 Go to **System > Update > Support**.
- 2 Select Support Login.

- 3 Enter your Fortinet support user name and password.
- 4 Select Login.
- 5 Select My Profile.
- 6 Select Edit Profile.
- 7 Make the required changes to your contact information.
- 8 Make the required changes to your security question and answer.
- 9 Select Update Profile.

Your changes are saved to the Fortinet technical support database. If you changed your contact information, the changes are displayed.

Downloading virus and attack definitions updates

Use the following procedure to manually download virus and attack definitions updates. This procedure also describes how to install the attack definitions updates on your FortiGate unit.

To download virus and attack definitions updates

- 1 Go to **System > Update > Support**.
- 2 Select Support Login.
- 3 Enter your Fortinet support user name and password.
- 4 Select Login.
- 5 Select Download Virus/Attack Update.
- 6 If required, select the FortiOS version.
- 7 Select the virus and attack definitions to download.

Figure 43: Downloading virus and attack definition updates

Download Virus/Attack Updates		
		Version: v2.36 v2.30
FGT Unit	Virus Definition	Attack Definition
FGT-50	OS2.3.6_4.77.	2.36-1.41
FGT-60		2.36-1.41
FGT-100	OS2.3.6_4.77.	2.36-1.41
FGT-200	OS2.3.6_4.77.	2.36-1.41
FGT-300	OS2.3.6_4.77.	2.36-1.41
FGT-400	OS2.3.6_4.77.	2.36-1.41
FGT-500	OS2.3.6_4.77.	2.36-1.41
FGT-1000		2.36-1.41
FGT-3000	OS2.3.6_4.77.	2.36-1.41
FGT-3600		2.36-1.41

For information about how to install the downloaded files, see [“Manual virus definition updates” on page 114](#) and [“Manual attack definition updates” on page 115](#).

Registering a FortiGate unit after an RMA

The Return Material Authorization (RMA) process starts when a registered FortiGate unit does not work properly because of a hardware failure. If this happens while the FortiGate unit is protected by hardware coverage, you can return the FortiGate unit that is not functioning to your reseller or distributor.

The RMA is recorded and you will receive a replacement unit. Fortinet adds the RMA information to the Fortinet support database. When you receive the replacement unit you can use the following procedure to update your product registration information.

To register a FortiGate unit after an RMA

- 1 Go to **System > Update > Support**.
- 2 Select Support Login.
- 3 Enter your Fortinet support user name and password to log in.
- 4 Select Add Registration.
- 5 Select the link to replace a unit with a new unit from an RMA.
- 6 Select Finish.

The list of FortiGate products that you have registered is displayed. The list now includes the replacement FortiGate unit. All support levels are transferred to the replacement unit.

Network configuration

You can use the System Network page to change any of the following FortiGate network settings:

- [Configuring zones](#)
- [Configuring interfaces](#)
- [Out of band management](#)
- [VLAN overview](#)
- [VLANs in NAT/Route mode](#)
- [Virtual domains in Transparent mode](#)
- [Adding DNS server IP addresses](#)
- [Configuring routing](#)
- [Configuring DHCP services](#)

Configuring zones

In NAT/Route mode, you can use zones to group related interfaces and VLAN subinterfaces. Grouping interfaces and VLAN subinterfaces into zones simplifies policy creation. If you group interfaces and VLAN subinterfaces into a zone, you can configure policies for connections to and from this zone, rather than to and from each interface and VLAN subinterface.

You can add zones, rename and edit zones, and delete zones from the zone list.

A new zone does not appear in the policy grid until you add an interface to it (see [“Adding an interface to a zone” on page 143](#)) and add a firewall address for it (see [“Adding addresses” on page 202](#)).

This section describes:

- [Adding zones](#)
- [Deleting zones](#)

Adding zones

The new zone does not appear in the policy grid until you add an interface to it, see [“To add an interface to a zone”](#) below, and add a firewall address for it (see [“Adding addresses”](#) on page 202).

To add a zone

- 1 Go to **System > Network > Zone**.
- 2 Select New.
- 3 Type a name for the zone.
The name can contain numbers (0-9), uppercase and lowercase letters (A-Z, a-z), and the special characters - and _. Other special characters and spaces are not allowed.
- 4 Select the Block intra-zone traffic check box if you want to block traffic between interfaces in the same zone.
- 5 Select OK.

Deleting zones

You must remove all interfaces and VLAN subinterfaces from a zone before you can delete the zone. You can only delete zones that have the Delete icon  beside them in the zone list.

To delete a zone

- 1 Go to **System > Network > Zone**.
- 2 Select Delete  to remove a zone from the list.
- 3 Select OK to delete the zone.

Configuring interfaces

Use the following procedures to configure FortiGate interfaces and VLAN subinterfaces. All of these procedures can be used for physical FortiGate interfaces and for VLAN subinterfaces.

- [Viewing the interface list](#)
- [Changing the administrative status of an interface](#)
- [Adding an interface to a zone](#)
- [Configuring an interface with a manual IP address](#)
- [Configuring an interface for DHCP](#)
- [Configuring an interface for PPPoE](#)
- [Adding a secondary IP address to an interface](#)
- [Adding a ping server to an interface](#)
- [Controlling administrative access to an interface](#)
- [Changing the MTU size to improve network performance](#)
- [Configuring traffic logging for connections to an interface](#)
- [Configuring the management interface in Transparent mode](#)

Viewing the interface list

To view the interface list

- 1 Go to **System > Network > Interface**.
The interface list is displayed. The interface list shows the following status information for all the FortiGate interfaces and VLAN subinterfaces:
 - The name of the interface
 - The IP address of the interface
 - The netmask of the interface
 - The zone that the interface has been added to
 - The administrative access configuration for the interface
See [“Controlling administrative access to an interface” on page 147](#) for information about administrative access options.
 - The administrative status for the interface
If the administrative status is a green arrow, the interface is up and can accept network traffic. If the administrative status is a red arrow, the interface is administratively down and cannot accept traffic. To change the administrative status, see [“Changing the administrative status of an interface” on page 143](#).

Changing the administrative status of an interface

You can use the following procedures to start an interface that is administratively down and stop an interface that is administratively up.

To start up an interface that is administratively down

- 1 Go to **System > Network > Interface**.
The interface list is displayed.
- 2 Select Bring Up for the interface that you want to start.

To stop an interface that is administratively up

- 1 From the FortiGate CLI, enter the command:

```
set system interface <intf_str> config status down
```

You can only stop an interface that is administratively up from the FortiGate command line interface (CLI).

Adding an interface to a zone

If you have added zones to the FortiGate unit, you can use the following procedure to add an interface or VLAN subinterface to a zone.

You must delete any firewall addresses added to an interface or VLAN subinterface before adding the interface or VLAN subinterface to a zone. For information about deleting addresses, see [“Deleting addresses” on page 204](#).

When you add an interface or VLAN subinterface to a zone, you cannot add firewall addresses to the interface or VLAN subinterface and the interface or VLAN subinterface does not appear on the policy grid.

To add an interface to a zone

- 1 Go to **System > Network > Interface**.
- 2 Choose the interface or VLAN subinterface to add to a zone and select Modify .
- 3 From the Belong to Zone list, select the zone that you want to add the interface to. The belong to zone list only appears if you have added zones and if you have not added firewall addresses for the interface.
- 4 Select OK to save the changes.
- 5 Repeat these steps to add more interfaces or VLAN subinterfaces to zones.

Configuring an interface with a manual IP address

You can change the static IP address of any FortiGate interface.

To change an interface with a manual IP address

- 1 Go to **System > Network > Interface**.
- 2 Choose an interface and select Modify .
- 3 Set Addressing Mode to Manual.
- 4 Change the IP address and Netmask as required.
The IP address of the interface must be on the same subnet as the network the interface is connecting to.
Two interfaces cannot have the same IP address and cannot have IP addresses on the same subnet.
- 5 Select OK to save your changes.
If you changed the IP address of the interface to which you are connecting to manage the FortiGate unit, you must reconnect to the web-based manager using the new interface IP address.

Configuring an interface for DHCP

You can configure any FortiGate interface to use DHCP.

If you configure the interface to use DHCP, the FortiGate unit automatically broadcasts a DHCP request. You can disable connect to server if you are configuring the FortiGate unit offline and you do not want the FortiGate unit to send the DHCP request.

By default, the FortiGate unit also retrieves a default gateway IP address and DNS server IP addresses from the DHCP server. You can disable the option Retrieve default gateway and DNS from server if you do not want the DHCP server to configure these FortiGate settings.

To configure an interface for DHCP

- 1 Go to **System > Network > Interface**.
- 2 Choose an interface and select Modify .
- 3 In the Addressing Mode section, select DHCP.

- 4 Clear the Retrieve default gateway and DNS from server check box if you do not want the FortiGate unit to obtain a default gateway IP address and DNS server IP addresses from the DHCP server.
By default, this option is enabled.
- 5 Clear the Connect to Server check box if you do not want the FortiGate unit to connect to the DHCP server.
By default, this option is enabled.
- 6 Select Apply.
The FortiGate unit attempts to contact the DHCP server from the interface to set the IP address, netmask, default gateway IP address, and DNS server IP addresses.
- 7 Select Status to refresh the addressing mode status message.

initializing	No activity
connecting	The FortiGate unit is attempting to connect to the DHCP server.
connected	The FortiGate unit retrieves an IP address, netmask, and other settings from the DHCP server.
failed	The FortiGate unit was unable to retrieve an IP address and other information from the DHCP server.
- 8 Select OK.

Configuring an interface for PPPoE

Use the following procedure to configure any FortiGate interface to use PPPoE.

If you configure the interface to use PPPoE, the FortiGate unit automatically broadcasts a PPPoE request. You can disable connect to server if you are configuring the FortiGate unit offline and you do not want the FortiGate unit to send the PPPoE request.

By default, the FortiGate unit also retrieves a default gateway IP address and DNS server IP addresses from the PPPoE server. You can disable the option Retrieve default gateway and DNS from server if you do not want the PPPoE server to configure these FortiGate settings.

To configure an interface for PPPoE

- 1 Go to **System > Network > Interface**.
- 2 Choose an interface and select Modify .
- 3 In the Addressing Mode section, select PPPoE.
- 4 Enter your PPPoE account User Name and Password.
- 5 Clear the Retrieve default gateway and DNS from server check box if you do not want the FortiGate unit to obtain a default gateway IP address and DNS server IP addresses from the PPPoE server.
By default, this option is enabled.
- 6 Clear the Connect to Server check box if you do not want the FortiGate unit to connect to the PPPoE server.
By default, this option is enabled.

- 7 Select Apply.
The FortiGate unit attempts to contact the PPPoE server from the interface to set the IP address, netmask, default gateway IP address, and DNS server IP addresses.
- 8 Select Status: to refresh the addressing mode status message. Possible messages:

initializing	No activity
connecting	The FortiGate unit is attempting to connect to the DHCP server.
connected	The FortiGate unit retrieves an IP address, netmask, and other settings from the PPPoE server.
failed	The FortiGate unit was unable to retrieve an IP address and other information from the PPPoE server.
- 9 Select OK.

Adding a secondary IP address to an interface

You can use the CLI to add a secondary IP address to any FortiGate interface. The secondary IP address cannot be the same as the primary IP address but it can be on the same subnet.

To add a secondary IP address from the CLI enter the command:

```
set system interface <intf_str> config secip <second_ip>
<netmask_ip>
```

You can also configure management access and add a ping server to the secondary IP address.

```
set system interface <intf_str> config secallowaccess ping
https ssh snmp http telnet
set system interface <intf_str> config secgwdetect enable
```

Adding a ping server to an interface

Add a ping server to an interface if you want the FortiGate unit to confirm connectivity with the next hop router on the network connected to the interface. Adding a ping server is required for routing failover. See [“Adding destination-based routes to the routing table” on page 159](#).

To add a ping server to an interface

- 1 Go to **System > Network > Interface**.
- 2 Choose an interface and select Modify .
- 3 Set Ping Server to the IP address of the next hop router on the network connected to the interface.
- 4 Select the Enable check box.
The FortiGate unit uses dead gateway detection to ping the Ping Server IP address to make sure that the FortiGate unit can connect to this IP address. To configure dead gateway detection, see [“Modifying the Dead Gateway Detection settings” on page 177](#).
- 5 Select OK to save the changes.

Controlling administrative access to an interface

For a FortiGate unit running in NAT/Route mode, you can control administrative access to an interface to control how administrators access the FortiGate unit and the FortiGate interfaces to which administrators can connect.

Controlling administrative access for an interface connected to the Internet allows remote administration of the FortiGate unit from any location on the Internet. However, allowing remote administration from the Internet could compromise the security of your FortiGate unit. You should avoid allowing administrative access for an interface connected to the Internet unless this is required for your configuration. To improve the security of a FortiGate unit that allows remote administration from the Internet:

- Use secure administrative user passwords,
- Change these passwords regularly,
- Enable secure administrative access to this interface using only HTTPS or SSH,
- Do not change the system idle timeout from the default value of 5 minutes (see [“To set the system idle timeout” on page 176](#)).

To configure administrative access in Transparent mode, see [“Configuring the management interface in Transparent mode” on page 148](#).

To control administrative access to an interface

1 Go to **System > Network > Interface**.

2 Choose an interface and select Modify .

3 Select the Administrative Access methods for the interface.

HTTPS To allow secure HTTPS connections to the web-based manager through this interface.

PING If you want this interface to respond to pings. Use this setting to verify your installation and for testing.

HTTP To allow HTTP connections to the web-based manager through this interface. HTTP connections are not secure and can be intercepted by a third party.

SSH To allow SSH connections to the CLI through this interface.

SNMP To allow a remote SNMP manager to request SNMP information by connecting to this interface. See [“Configuring SNMP” on page 180](#).

TELNET To allow Telnet connections to the CLI through this interface. Telnet connections are not secure and can be intercepted by a third party.

4 Select OK to save the changes.

Changing the MTU size to improve network performance

To improve network performance, you can change the maximum transmission unit (MTU) of the packets that the FortiGate unit transmits from any interface. Ideally, this MTU should be the same as the smallest MTU of all the networks between the FortiGate unit and the destination of the packets. If the packets that the FortiGate unit sends are larger, they are broken up or fragmented, which slows down transmission. Experiment by lowering the MTU to find an MTU size for best network performance.

To change the MTU size of the packets leaving an interface

- 1 Go to **System > Network > Interface**.
- 2 Choose an interface and select Modify .
- 3 Select Override default MTU value (1500).
- 4 Set the MTU size.
Set the maximum packet size. For manual and DHCP addressing mode the MTU size can be from 576 to 1500 bytes. For PPPoE addressing mode the MTU size can be from 576 to 1492 bytes.

Configuring traffic logging for connections to an interface

To configure traffic logging for connections to an interface

- 1 Go to **System > Network > Interface**.
- 2 Choose an interface and select Modify .
- 3 Select the Log check box to record log messages whenever a firewall policy accepts a connection to this interface.
- 4 Select OK to save the changes.

Configuring the management interface in Transparent mode

Configure the management interface in Transparent mode to set the management IP address of the FortiGate unit. Administrators connect to this IP address to administer the FortiGate unit. The FortiGate also uses this IP address to connect to the FDN for virus and attack updates (see [“Updating antivirus and attack definitions” on page 123](#)).

You can also configure the management interface to control how administrators connect to the FortiGate unit for administration and the FortiGate interfaces to which administrators can connect.

Controlling administrative access to a FortiGate interface connected to the Internet allows remote administration of the FortiGate unit from any location on the Internet. However, allowing remote administration from the Internet could compromise the security of the FortiGate unit. You should avoid allowing administrative access for an interface connected to the Internet unless this is required for your configuration. To improve the security of a FortiGate unit that allows remote administration from the Internet:

- Use secure administrative user passwords,
- Change these passwords regularly,

- Enable secure administrative access to this interface using only HTTPS or SSH,
- Do not change the system idle timeout from the default value of 5 minutes (see [“To set the system idle timeout” on page 176](#)).

To configure the management interface in Transparent mode

- 1 Go to **System > Network > Management**.
- 2 Change the Management IP and Netmask as required.
This must be a valid IP address for the network that you want to manage the FortiGate unit from.
- 3 Add a default gateway IP address if the FortiGate unit must connect to a default gateway to reach the management computer.
- 4 Select the administrative access methods for each interface.

HTTPS	To allow secure HTTPS connections to the web-based manager through this interface.
PING	If you want this interface to respond to pings. Use this setting to verify your installation and for testing.
HTTP	To allow HTTP connections to the web-based manager through this interface. HTTP connections are not secure and can be intercepted by a third party.
SSH	To allow SSH connections to the CLI through this interface.
SNMP	To allow a remote SNMP manager to request SNMP information by connecting to this interface. See “Configuring SNMP” on page 180 .
TELNET	To allow Telnet connections to the CLI through this interface. Telnet connections are not secure and can be intercepted by a third party.
- 5 Select Log for each interface that you want to record log messages whenever a firewall policy accepts a connection to this interface.
- 6 Select Apply to save the changes.

Out of band management

Configure the out of band management interface to set the out of band management IP address of the FortiGate-4000 unit. You can also change the default route for the out of band management interface and control administrative access connect to the out of band management interface.

The out of band management interface is available in NAT/Route mode and in Transparent mode.

To configure the out of band management interface

- 1 Go to **System > Network > OOB Management**.
- 2 Change the IP and Netmask as required.
This must be a valid IP address for the network that you want to manage the FortiGate unit from.
- 3 Add a default gateway IP address if one is required for your network.
- 4 Select the administrative access methods for the out of band management interface.

- HTTPS** To allow secure HTTPS connections to the web-based manager through this interface.
 - PING** If you want this interface to respond to pings. Use this setting to verify your installation and for testing.
 - HTTP** To allow HTTP connections to the web-based manager through this interface. HTTP connections are not secure and can be intercepted by a third party.
 - SSH** To allow SSH connections to the CLI through this interface.
 - SNMP** To allow a remote SNMP manager to request SNMP information by connecting to this interface. See [“Configuring SNMP” on page 180](#).
 - TELNET** To allow Telnet connections to the CLI through this interface. Telnet connections are not secure and can be intercepted by a third party.
- 5 Select Log for the interface if you want to record log messages whenever and administrator connects to the out of band management interface.
 - 6 Select Apply to save the changes.

Out of band management interface CLI command

From the CLI, you can use the `set system oobmanagement` command to configure the out of band management interface.

Syntax description

Keyword	Description
<code>ip <manage_ip> <netmask_ip></code>	Set the IP address and netmask of the out of band management interface.
<code>allowaccess {ping https snmp ssh http telnet}</code>	Allow management access to the out of band management interface. You can enter one or more of the management access types separated by spaces.
<code>denyaccess {ping https snmp ssh http telnet}</code>	Deny management access to the out of band management interface. You can enter one or more of the management access types separated by spaces.
<code>gw <gw_ip></code>	The IP address of the default gateway for the network to which the out of band management interface is connected.
<code>log {enable disable}</code>	Enable or disable traffic logging of connections to the out of band management interface.

VLAN overview

FortiGate units support IEEE 802.1Q Virtual LAN (VLAN) technology. A VLAN is group of PCs, servers, and other network devices that communicate as if they were on the same LAN segment, even though they may not be. For example, the workstations and servers for an accounting department could be scattered throughout an office, connected to numerous network segments, but they can still belong to the same VLAN.

A VLAN segregates devices logically instead of physically. Each VLAN is treated as a broadcast domain. Devices in VLAN 1 can connect with other devices in VLAN 1, but cannot connect with devices in other VLANs. The communication among devices on a VLAN is independent of the physical network.

A VLAN segregates devices by adding 802.1Q VLAN tags to all of the packets sent and received by the devices in the VLAN. VLAN tags are 4-byte frame extensions that contain a VLAN identifier as well as other information.

In a typical VLAN configuration, 802.1Q-compliant VLAN layer-2 switches or layer-3 routers or firewalls add VLAN tags to packets. Packets passing between devices in the same VLAN can be handled by layer 2 switches. Packets passing between devices in different VLANs must be handled by a layer 3 device such as router, firewall, or layer 3 switch.

Operating in NAT/Route mode, the FortiGate unit functions as a layer 3 device to control the flow of packets between VLANs. See [“VLANs in NAT/Route mode” on page 151](#) for more information.

Operating in Transparent mode, the FortiGate unit functions as a layer 2 device to control the flow of packets between segments in the same VLAN. See [“Virtual domains in Transparent mode” on page 153](#).

VLANs in NAT/Route mode

In NAT/Route mode, FortiGate units support VLANs for constructing VLAN trunks between an IEEE 802.1Q-compliant switch (or router) and the FortiGate unit. Normally the FortiGate unit internal interface connects to a VLAN trunk on an internal switch, and the external interface connects to an upstream Internet router untagged. The FortiGate unit can then apply different policies for traffic on each VLAN that connects to the internal interface.

In this configuration, you add VLAN subinterfaces to the FortiGate internal interface that have VLAN IDs that match the VLAN IDs of packets in the VLAN trunk. The FortiGate unit directs packets with VLAN IDs, to subinterfaces with matching VLAN IDs.

You can also define VLAN subinterfaces on all FortiGate interfaces. The FortiGate unit can add VLAN tags to packets leaving a VLAN subinterface or remove VLAN tags from incoming packets and add different VLAN tags to outgoing packets.

Rules for VLAN IDs

Two VLAN subinterfaces added to the same physical interface cannot have the same VLAN ID. However, you can add two or more VLAN subinterfaces with the same VLAN IDs to different physical interfaces. There is no internal connection or link between two VLAN subinterfaces with same VLAN ID. Their relationship is the same as the relationship between any two FortiGate network interfaces.

Rules for VLAN IP addresses

IP addresses of all FortiGate interfaces cannot overlap. That is, the IP addresses of all interfaces must be on different subnets. This rule applies to both physical interfaces and to VLAN subinterfaces.



Note: You can enter the CLI command `set system ip-overlap enable` to allow IP address overlap. If you enter this command, multiple VLAN interfaces can have an IP address that is part of a subnet used by another interface. This command is recommended for advanced users only.

Adding VLAN subinterfaces

The VLAN ID of each VLAN subinterface must match the VLAN ID added by the IEEE 802.1Q-compliant router. The VLAN ID can be any number between 1 and 4096. Each VLAN subinterface must also be configured with its own IP address and netmask.

You add VLAN subinterfaces to the physical interface that receives VLAN-tagged packets.

To add VLAN subinterfaces

- 1 Go to **System > Network > Interface**.
- 2 Select **New VLAN** to add a VLAN subinterface.
- 3 Enter a Name to identify the VLAN subinterface.
The name can contain numbers (0-9), uppercase and lowercase letters (A-Z, a-z), and the special characters - and _. Other special characters and spaces are not allowed.
- 4 Select the interface that receives the VLAN packets intended for this VLAN subinterface.
- 5 Enter the VLAN ID that matches the VLAN ID of the packets to be received by this VLAN subinterface.
The VLAN ID can be any number between 1 and 4096 but must match the VLAN ID added by the IEEE 802.1Q-compliant router or switch.
- 6 Configure the VLAN subinterface settings as you would for any FortiGate interface. You can add the VLAN subinterface to a zone, configure addressing, add a ping server, and configure administrative access to the VLAN subinterface. For more information, see [“Configuring interfaces” on page 142](#).
- 7 Select OK to save your changes.
The FortiGate unit adds the new subinterface to the interface that you selected in step 4.

Virtual domains in Transparent mode

In Transparent mode, The FortiGate unit can apply firewall policies and services, such as virus scanning, to traffic on an IEEE 802.1 VLAN trunk. The FortiGate unit operating in Transparent mode can be inserted into the trunk without making changes to the network. In a typical configuration, the FortiGate internal interface accepts VLAN packets on a VLAN trunk from a VLAN switch or router connected to internal VLANs. The FortiGate external interface forwards tagged packets through the trunk to an external VLAN switch or router. This external switch or router could be connected to the Internet. The FortiGate unit can be configured to apply different policies for traffic on each VLAN in the trunk.

To support VLANs in Transparent mode, you add virtual domains to the FortiGate unit. A virtual domain contains at least 2 VLAN subinterfaces. For VLAN traffic to be able to pass between the FortiGate Internal and external interface you would add a VLAN subinterface to the internal interface and another VLAN subinterface to the external interface. If these VLAN subinterfaces have the same VLAN IDs, the FortiGate unit applies firewall policies to the traffic on this VLAN. If these VLAN subinterfaces have different VLAN IDs, or if you add more than two VLAN subinterfaces to the virtual domain, you can also use firewall policies to control connections between VLANs.

When the FortiGate unit receives a VLAN tagged packet at an interface, the packet is directed to the VLAN subinterface with matching VLAN ID. The VLAN subinterface removes the VLAN tag and assigns a destination interface to the packet based on its destination MAC address. The firewall policies for this source and destination VLAN subinterface pair are applied to the packet. If the packet is accepted by the firewall, the FortiGate unit forwards the packet to the destination VLAN subinterface. The destination VLAN ID is added to the packet and it is sent to the VLAN trunk.

When a packet enters a virtual domain on the FortiGate unit, it is confined to that virtual domain. In a given domain, you can only create firewall policies for connections between VLAN subinterfaces or zones in the virtual domain. The packet never crosses the virtual domain border.

The FortiGate-4000 supports 512 virtual domains.

- [Virtual domain properties](#)
- [Configuring a virtual domain](#)
- [Adding firewall policies for virtual domains](#)
- [Deleting virtual domains](#)

Figure 44: FortiGate unit with two virtual domains

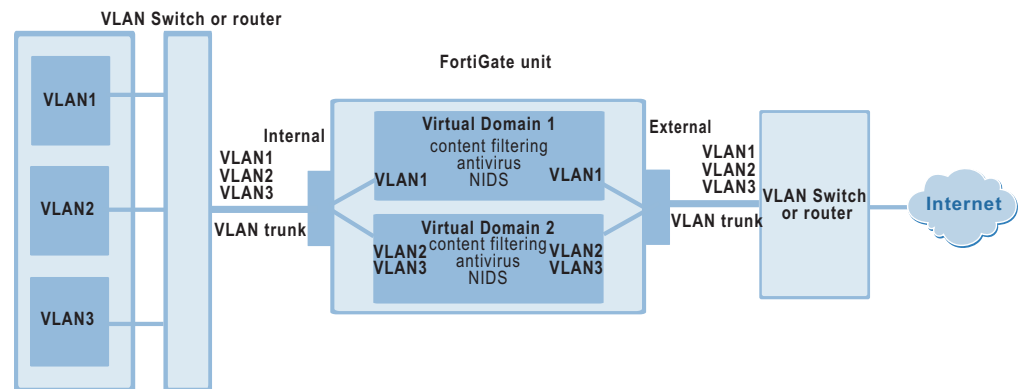

Virtual domain properties

A virtual domain has the following exclusive properties:

- VLAN name,
- VLAN ID,
- VLAN interface assignment,
- VLAN zone assignment (optional),
- Firewall policy.

Virtual domains share the following global properties with other processes on the FortiGate unit:

- System settings,
- Firewall policy objects (addresses, services, schedule, content profiles, and so on),
- User information,
- NIDS settings,
- Antivirus, Web filter, Mail filter settings,
- Log & report settings.

In addition to the global properties, virtual domains share a common administrative model. Administrators have access to all of the virtual domains on the FortiGate unit. Only their administrative access level varies.

Configuring a virtual domain

Configure a virtual domain by adding the virtual domain to the FortiGate configuration. Then add matching pairs of VLAN subinterfaces to the virtual domain.

- [Adding a virtual domain](#)
- [Adding VLAN subinterfaces to a virtual domain](#)
- [Adding zones to virtual domains](#)

Adding a virtual domain

Use the following procedure to add a virtual domain to the FortiGate unit. You must add at least one virtual domain to support VLANs in Transparent mode. Add more virtual domains to simplify configuration if you are planning to add a large number of VLANs.

To add a virtual domain

- 1 Go to **System > Virtual Domain**.
- 2 Select New to add a virtual domain.
- 3 Type a Name for the virtual domain.
- 4 Select OK to add the virtual domain.

Adding VLAN subinterfaces to a virtual domain

Use the following procedure to add VLAN subinterfaces to a virtual domain. You must add at least two VLAN subinterfaces to each virtual domain. In most configurations a virtual domain is used to send VLAN-tagged packets received at one FortiGate physical interface to another FortiGate physical interface (for example, from the internal interface to the external interface). For this to occur, you must add VLAN subinterfaces to the receiving and sending physical interfaces (for example, to the internal and external interfaces).

To add VLAN subinterfaces to a virtual domain

- 1 Go to **System > Network > VLAN**.
- 2 Select the Virtual Domain to add the VLAN subinterface to.
- 3 Select New to add a VLAN subinterface.
- 4 Type a Name for the VLAN subinterface.
- 5 Select the interface to associate the VLAN subinterface with.
The VLAN subeesr rh

Adding zones to virtual domains

Add zones to a virtual domain to group together related VLAN subinterfaces. Use zones to simplify firewall policy creation if you have many VLAN subinterfaces in a virtual domain. For more information about zones, see [“Configuring zones” on page 141](#). Use the following procedure to add a zone to a virtual domain.

Figure 45: FortiGate unit containing a virtual domain with zones

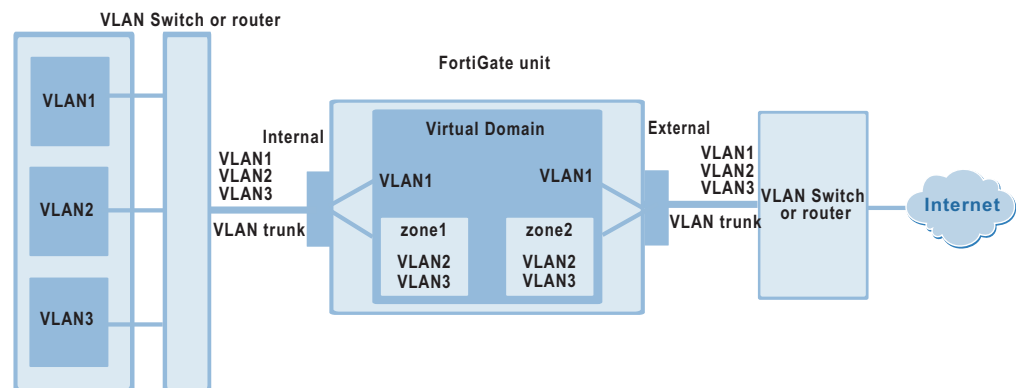

Multiple zones in a single virtual domain cannot be connected to a single VLAN trunk. This configuration is correct because each zone is connected to a different VLAN trunk (zone1 connected to the VLAN trunk on the internal interface and zone2 connected to the VLAN trunk on the external interface). If you were to add another zone (for example, zone3 connected to the VLAN trunk on the internal interface) the FortiGate unit would not be able to successfully differentiate between traffic for zone1 and zone3. This is the case because both zone 1 and zone3 traffic would be routed to the same MAC address.

To add a zone to a virtual domain

- 1 Go to **System > Network > Zone**.
- 2 Select New to add a zone.
- 3 Type a Name for the zone.
- 4 Select the Virtual Domain to add the zone to.
- 5 Optionally select Block intra-zone traffic to block traffic between VLAN subinterfaces in the same zone.
- 6 Select OK to add the zone.

To add VLAN subinterfaces to a zone

- 1 Go to **System > Network > VLAN**.
- 2 Set Virtual Domain to All or to the virtual domain containing the VLAN subinterfaces to add to a zone.
- 3 Select List to list all of VLAN subinterfaces added to the FortiGate unit or to the selected virtual domain.
- 4 For a VLAN subinterface to add to a zone, select Modify .
- 5 From the zone list, select the name of the zone to add the VLAN subinterface to.

- 6 Select OK to save your changes.
You can also use the procedure [“Adding VLAN subinterfaces” on page 152](#) to add a VLAN subinterface to a zone if you are adding new VLAN subinterfaces to a virtual domain to which you have already added zones.

Adding firewall policies for virtual domains

Once the network configuration for the virtual domain is complete, you must create firewall policies for the virtual domain to allow packets to flow through the firewall between VLAN subinterfaces.

- [Adding addresses for virtual domains](#)
- [Adding firewall policies for virtual domains](#)

Adding addresses for virtual domains

Before you can create firewall policies for a virtual domain, you must add source and destination addresses for the VLAN subinterfaces and zones added to the virtual domain.

- 1 Go to **Firewall > Address**.
- 2 Select the VLAN subinterface or zone to which to add the address.
- 3 Select New to add a new address.
- 4 Enter an Address Name to identify the address.
- 5 Enter the IP Address.
- 6 Enter the NetMask.
- 7 Select OK to add the address.

Adding firewall policies for virtual domains

Add Firewall policies to control connections and traffic between FortiGate VLAN subinterfaces and zones in a virtual domain.

- 1 Go to **Firewall > Policy**.
- 2 Select the Virtual Domain to which you want to add the policy.
- 3 Select a source VLAN subinterface or zone.
- 4 Select a destination VLAN subinterface or zone.
VLAN subinterfaces or zones only appear in the source and destination lists if they have been added to the selected virtual domain and if you have added firewall addresses for them.
The source and destination cannot be the same VLAN subinterface or zone.
- 5 Select New to add a new policy.
- 6 Configure the policy.
- 7 Select OK to add the policy.

Deleting virtual domains

You must remove all VLAN subinterfaces and zones that have been added to the virtual domain before you can delete the virtual domain. To remove VLAN subinterfaces and zones you must remove all firewall policies and firewall addresses for the VLAN subinterfaces and zones. You can only delete virtual domains that have the Delete icon beside them in the zone list.

Delete the virtual domain components in the following order:

- firewall policies
- source and destination addresses
- VLAN subinterfaces
- zones
- the virtual domain

Adding DNS server IP addresses

Several FortiGate functions, including sending email alerts and URL blocking, use DNS. Use the following procedure to add the IP addresses of the DNS servers that your FortiGate unit can connect to. DNS server IP addresses are usually supplied by your ISP.

To add DNS server IP addresses

- 1 Go to **System > Network > DNS**.
- 2 Change the primary and secondary DNS server IP addresses as required.
- 3 Select Apply to save the changes.

Configuring routing

This section describes how to configure FortiGate routing. You can configure routing to add static routes from the FortiGate unit to local routers. Using policy routing you can increase the flexibility of FortiGate routing to support more advanced routing functions.

You can also use routing to create a multiple Internet connection configuration that supports redundancy and load sharing between the two Internet connections.

This section describes:

- [Adding a default route](#)
- [Adding destination-based routes to the routing table](#)
- [Adding routes in Transparent mode](#)
- [Configuring the routing table](#)
- [Policy routing](#)

Adding a default route

You can add a default route for network traffic leaving the external interface.

To add a default route

- 1 Go to **System > Network > Routing Table**.
- 2 Select New to add a new route.
- 3 Set the Source IP and Netmask to 0.0.0.0.
- 4 Set the Destination IP and Netmask to 0.0.0.0.
- 5 Set Gateway 1 to the IP address of the routing gateway that routes traffic to the Internet.
- 6 Select OK to save the default route.



Note: Only one default route can be active at a time. If two default routes are added to the routing table, only the default route closest to the top of the routing table is active.

Adding destination-based routes to the routing table

You can add destination-based routes to the FortiGate routing table to control the destination of traffic exiting the FortiGate unit. You configure routes by adding destination IP addresses and netmasks and adding gateways for these destination addresses. The gateways are the next hop routers to which to route traffic that matches the destination addresses in the route.

You can add one or two gateways to a route. If you add one gateway, the FortiGate unit routes the traffic to that gateway. You can add a second gateway to route traffic to the second gateway if the first gateway fails.

To support routing failover, the IP address of each gateway must be added to the ping server of the interface connected to the same network as the gateway. For information about adding a ping server, see [“Adding a ping server to an interface” on page 146](#).

To add destination-based routes to the routing table

- 1 Go to **System > Network > Routing Table**.
- 2 Select New to add a new route.
- 3 Type the Destination IP address and netmask for the route.
- 4 Add the IP address of Gateway #1.
Gateway #1 is the IP address of the primary destination for the route.
Gateway #1 must be on the same subnet as a Fortigate interface.
If you are adding a static route from the FortiGate unit to a single destination router, you need to specify only one gateway.
- 5 Add the IP address of Gateway #2, if you want to route traffic to multiple gateways.

- 6 Set Device #1 to the FortiGate interface or VLAN subinterface through which to route traffic to connect to Gateway #1.

You can select the name of an interface, VLAN subinterface, or Auto (the default). If you select the name of an interface or VLAN subinterface the traffic is routed to that interface. If you select Auto the system selects the interface according to the following rules:

- If the Gateway #1 IP address is on the same subnet as a FortiGate interface or VLAN subinterface, the system sends the traffic to that interface.
- If the Gateway #1 IP address is not on the same subnet as a FortiGate interface or VLAN subinterface, the system routes the traffic to the external interface, using the default route.

You can use Device #1 to send packets to an interface that is on a different subnet than the destination IP address of the packets without routing them using the default route.

- 7 Set Device #2 to the FortiGate interface or VLAN subinterface through which to route traffic to connect to Gateway #2.

You can select the name of an interface, VLAN subinterface, or Auto (the default). If you select the name of an interface or VLAN subinterface the traffic is routed to that interface. If you select Auto the system selects the interface according to the following rules:

- If the Gateway #2 IP address is on the same subnet as a FortiGate interface or VLAN subinterface, the system sends the traffic to that interface.
- If the Gateway #2 IP address is not on the same subnet as a FortiGate interface or VLAN subinterface, the system routes the traffic to the external interface, using the default route.

You can use Device #2 to send packets to an interface that is on a different subnet than the destination IP address of the packets without routing them using the default route.

- 8 Select OK to save the route.



Adding routes in Transparent mode

Use the following procedure to add routes when operating the FortiGate unit in Transparent mode.

To add a route in Transparent mode

- 1 Go to **System > Network > Routing**.
- 2 Select New.
- 3 Enter the Destination IP address and Netmask for the route.
- 4 Enter the Gateway IP address for the route.

5 Select OK to save the new route.

6

Using policy routing you can build a routing policy database (RPDB) that selects the appropriate route for traffic by applying a set of routing rules. To select a route for traffic, the FortiGate unit matches the traffic with the policy routes added to the RPDB starting at the top of the list. The first policy route that matches is used to set the route for the traffic. The route supplies the next hop gateway as well as the FortiGate interface to be used by the traffic.

Packets are matched with policy routes before they are matched with destination routes. If a packet does not match a policy route, it is routed using destination routes.

The gateway added to a policy route must also be added to a destination route. When the FortiGate unit matches packets with a route in the RPDB, the FortiGate unit looks in the destination routing table for the gateway that was added to the policy route. If a match is found, the FortiGate unit routes the packet using the matched destination route. If a match is not found, the FortiGate unit routes the packet using normal routing.

To find a route with a matching gateway, the FortiGate unit starts at the top of the destination routing table and searches until it finds the first matching destination route. This matched route is used to route the packet.

Policy routing command syntax

Configure policy routing using the following CLI command.

```
set system route policy <route_int> src <source_ip>  
<source_mask> iifname <source-interface_name>  
dst <destination_ip> <destination_mask>  
oifname <destination-interface_name> protocol <protocol_int>  
port <low-port_int> <high-port_int> gw <gateway_ip>
```

Complete policy routing command syntax is described in *Volume 6: FortiGate CLI Reference Guide*.

Configuring DHCP services

You can configure DHCP server or DHCP relay agent functionality on any FortiGate interface.

A FortiGate interface can act as either a DHCP server or as a DHCP relay agent. An interface cannot provide both functions.



Note: To configure DHCP server or DHCP relay functionality on an interface, the FortiGate unit must be in NAT/Route mode and the interface must have a static IP address.

This section describes the following:

- [Configuring a DHCP relay agent](#)
- [Configuring a DHCP server](#)

Configuring a DHCP relay agent

In a DHCP relay configuration, the FortiGate unit forwards DHCP requests from DHCP clients through the FortiGate unit to a DHCP server. The FortiGate unit also returns responses from the DHCP server to the DHCP clients. The DHCP server must have a route to the FortiGate unit that is configured as the DHCP relay so that the packets sent by the DHCP server to the DHCP client arrive at the FortiGate performing DHCP relay.

To configure an interface as a DHCP relay agent

- 1 Go to **System > Network > DHCP**.
- 2 Select Service.
- 3 Select the interface to be the DHCP relay agent.
- 4 Select DHCP Relay Agent.
- 5 Enter the DHCP Server IP address.
- 6 Select Apply.

Configuring a DHCP server

As a DHCP server, the FortiGate unit dynamically assigns IP addresses to hosts located on connected subnets. You can configure a DHCP server for any FortiGate interface. You can also configure a DHCP server for more than one FortiGate interface. For each DHCP server configuration you can add multiple scopes (also called address scopes) so that the DHCP server can assign IP addresses to computers on multiple subnets.

Use these procedures to configure an interface as a DHCP server:

- [Adding a DHCP server to an interface](#)
- [Adding scopes to a DHCP server](#)
- [Adding a reserve IP to a DHCP server](#)
- [Viewing a DHCP server dynamic IP list](#)

Adding a DHCP server to an interface

To add a DHCP server to an interface

- 1 Go to **System > Network > DHCP**.
- 2 Select Service.
- 3 Select an interface.
- 4 Select DHCP Server.
- 5 Select Apply.

Adding scopes to a DHCP server

If you have configured an interface as a DHCP server, the interface requires at least one scope (also called an address scope). The scope designates the starting IP and ending IP for the range of addresses that the FortiGate unit assigns to DHCP clients.

You can add multiple scopes to an interface so that the DHCP server added to that interface can supply IP addresses to computers on multiple subnets.

Add multiple scopes if the DHCP server receives DHCP requests from subnets that are not connected directly to the FortiGate unit. In this case, the DHCP requests are sent to the FortiGate unit through DHCP relay. DHCP relay packets contain DHCP relay IP, which is the IP address of the subnet from which the DHCP relay received the request.

If the DHCP request received by the DHCP server is not forwarded by a DHCP relay, the DHCP server decides which scope to use based on the IP address of the interface that received the DHCP request; usually the scope with the same subnet as the interface.

If the DHCP request received by the server is forwarded by a DHCP relay, the relay IP is used to select the scope.

To add a scope to a DHCP server

1 Go to **System > Network > DHCP**.

2 Select Address Scope.

3 Select an interface.

You must configure the interface as a DHCP server before it can be selected.

4 Select New to add an address scope.

5 Configure the address scope.

Scope Name Enter the address scope name.

IP Pool Enter the starting IP and ending IP for the range of IP addresses that this DHCP server assigns to DHCP clients.

Netmask Enter the netmask that the DHCP server assigns to the DHCP clients.

Lease Duration Enter the interval, in days, hours and minutes, after which a DHCP client must ask the DHCP server for a new address.
If you select Unlimited, DHCP leases never expire.

Domain Optionally enter in the domain that the DHCP server assigns to the DHCP clients.

Default Route Enter the default route to be assigned to DHCP clients. The default route must be on the same subnet as the IP pool.

6 Select Advanced if you want to configure Advanced Options.

DNS IP Enter the addresses of up to 3 DNS servers that the DHCP server assigns to the DHCP clients.

WINS Server IP Add the IP addresses of one or two WINS servers to be assigned to DHCP clients.

Exclusion Range Optionally enter up to 4 exclusion ranges of IP addresses within the IP pool that cannot be assigned to DHCP clients.

7 Select OK.

Adding a reserve IP to a DHCP server

If you have configured an interface as a DHCP server, you can reserve an IP address for a particular device on the network according to the MAC address of the device. When you add the MAC address of a device and an IP address to the reserve IP list, the DHCP server always assigns this IP address to the device.

To add a reserve IP you must first select the interface and scope to which you want to add the reserve IP.

To add a reserve IP to a DHCP server

- 1 Go to **System > Network > DHCP**.
- 2 Select Reserve IP.
- 3 Select an interface.
You must configure the interface as a DHCP server before you can select it.
- 4 Select a scope.
You must configure an address scope for the interface before you can select it.
- 5 Select New to add a reserved IP.
- 6 Configure the reserved IP.

IP Enter an IP address. The IP address must be within the IP pool added to the selected scope.

MAC Enter the MAC address of the device.

Name Optionally, specify a name for the IP and MAC address pair.



Note: The reserved IP cannot be assigned to any other device. You can only add a given IP address or MAC address once.

- 7 Select OK.

Viewing a DHCP server dynamic IP list

You can view the list of IP addresses that the DHCP server has assigned, their corresponding MAC addresses, and the expiry time and date for these addresses.

To view a DHCP server dynamic IP list

- 1 Go to **System > Network > DHCP**.
- 2 Select Dynamic IP.
- 3 Select the interface for which you want to view the list.

RIP configuration

The FortiGate implementation of the Routing Information Protocol (RIP) supports both RIP version 1 as defined by RFC 1058, and RIP version 2 as defined by RFC 2453. RIP version 2 enables RIP messages to carry more information, and to support simple authentication and subnet masks.

RIP is a distance-vector routing protocol intended for small, relatively homogeneous, networks. RIP uses hop count as its routing metric. Each network is usually counted as one hop. The network diameter is limited to 15 hops.

This chapter describes how to configure FortiGate RIP:

- [RIP settings](#)
- [Configuring RIP for FortiGate interfaces](#)
- [Adding RIP filters](#)

RIP settings

To configure RIP on the FortiGate unit

1 Go to **System > RIP > Settings**.

2 Select Enable RIP.

When you enable RIP, the Fortigate unit starts the RIP process. The FortiGate unit does not send or receive RIP packets until you enable RIP on at least one interface. For information about configuring RIP, see "[Configuring RIP for FortiGate interfaces](#)" on page 169.

3 Select Enable Advertise Default if you want RIP to always send the default route to neighbors whether or not the default route is in the static routing table.

If you disable Advertise Default, RIP never sends the default route.

4 Change the following RIP default settings, as required.

RIP defaults are effective in most configurations. You should only have to change these settings to troubleshoot problems with the RIP configuration.

Default Metric	RIP uses the default metric to advertise routes learned from other routing protocols. Set Default Metric to a positive integer lower than 16 to advertise that metric for all routes learned from other routing protocols. The default setting for the Default Metric is 2.
Input Queue	Change the depth of the RIP input queue. The higher the number, the deeper the input queue. Change the input queue depth to prevent loss of information from the routing table when you have a FortiGate unit sending at high speed to a router that cannot receive at high speed. The range is 0 to 1024. The default input queue depth is 50. A queue size of 0 means there is no input queue.
Output Delay	Add a delay in milliseconds between packets in a multiple-packet RIP update. Add an output delay if you are configuring RIP on a FortiGate unit that could be sending packets to a router that cannot receive the packets at the rate the FortiGate unit is sending them. Output Delay can be from 8 to 50 milliseconds. The default output delay is 0 milliseconds.

- 5 Change the following RIP timer settings, as required.
RIP timer defaults are effective in most configurations. You should only have to change these timers to troubleshoot network routing problems. All routers and access servers in the network should have the same RIP timer settings.

Update	The time interval in seconds between RIP updates. The default is 30 seconds.
Invalid	The time interval in seconds after which a route is declared invalid. Invalid should be at least three times the value of Update. During the invalid interval, after the first update is missed and before the invalid timer expires, the route is marked inaccessible and advertised as unreachable; however, the route is still used for forwarding packets. The invalid interval allows for the loss of one or more update packets before RIP considers the route unusable. If RIP receives an update for a route, before the invalid timer expires, it resets the invalid timer to 0. The default for Invalid is 180 seconds.
Holddown	The time interval in seconds during which RIP ignores routing information for a route. Holddown should be at least three times the value Update. A route enters the holddown state when RIP receives an update packet indicating that a route is unreachable or when the invalid timer for the route expires. The holddown interval allows time for bad routing information to clear the network during network convergence. The route is marked inaccessible and advertised as unreachable and is no longer used for forwarding packets. The default for Holddown is 180 seconds.
Flush	The time in seconds that must elapse after the last update for a route before RIP removes the route from the routing table. Flush should be greater than the value of Invalid to allow the route to go into the holddown state. The default for Flush is 240 seconds.

- 6 Select Apply to save the changes.

Figure 47: Configuring RIP settings

The screenshot shows the FortiGate configuration interface for RIP settings. It features three tabs: 'Settings', 'Interface', and 'Filter'. The 'Interface' tab is active. The configuration area contains the following elements:

- Enable RIP
- Enable Advertise Default
- Default Metric:
- Input Queue:
- Output Delay:
- RIP Timer:**
 - Update: (secs)
 - Invalid: (secs)
 - Holddown: (secs)
 - Flush: (secs)
-

Configuring RIP for FortiGate interfaces

You can customize a RIP configuration for each FortiGate interface. This allows you to customize RIP for the network to which each interface is connected.

To configure RIP for FortiGate interfaces

- 1 Go to **System > RIP > Interface**.
On this page you can view a summary of the RIP settings for each FortiGate interface.
- 2 Select Modify  for the interface for which to configure RIP settings.
- 3 Configure any of the following RIP settings:

- RIP1 Send** Enables sending RIP version 1 broadcasts from this interface to the network it is connected to. The routing broadcasts are UDP packets with a destination port of 520.
- RIP1 Receive** Enables listening on port 520 of an interface for RIP version 1 broadcasts.
- RIP2 Send** Enables sending RIP version 2 broadcasts from this interface to the network it is connected to. The routing broadcasts are UDP packets with a destination port of 520.
- RIP2 Receive** Enables listening on port 520 of an interface for RIP version 2 broadcasts.
- Split-Horizon** Prevents RIP from sending updates for a route back out the interface from which it received those routes. Split horizon is enabled by default. You should only disable split horizon if there is no possibility of creating a counting to infinity loop when network topology changes.
- Authentication** Enables authentication for RIP version 2 packets sent and received by an interface. Because the original RIP standard does not support authentication, authentication is only available for RIP version 2.

- Password** Enter the password to be used for RIP version 2 authentication. The password can be up to 16 characters long.
- Mode** Defines the authentication used for RIP version 2 packets sent and received by this interface. If you select Clear, the password is sent as plain text. If you select MD5, the password is used to generate an MD5 hash.
MD5 only guarantees the authenticity of the update packet, not the confidentiality of the routing information in the packet.
- Metric** Changes the metric for routes sent by this interface. All routes sent from this interface have this metric added to their current metric value. You can change the interface metric to give a higher priority to an interface. For example, if you have two interfaces that can be used to route packets to the same destination, and you set the metric of one interface higher than the other, the routes to the interface with the lower metric will seem to have a lower cost. More traffic will use routes to the interface with the lower metric. Metric can be from 1 to 16 with 16 equalling unreachable.

- 4 Select OK to save the RIP configuration for the selected interface.

Figure 48: Example RIP configuration for an internal interface

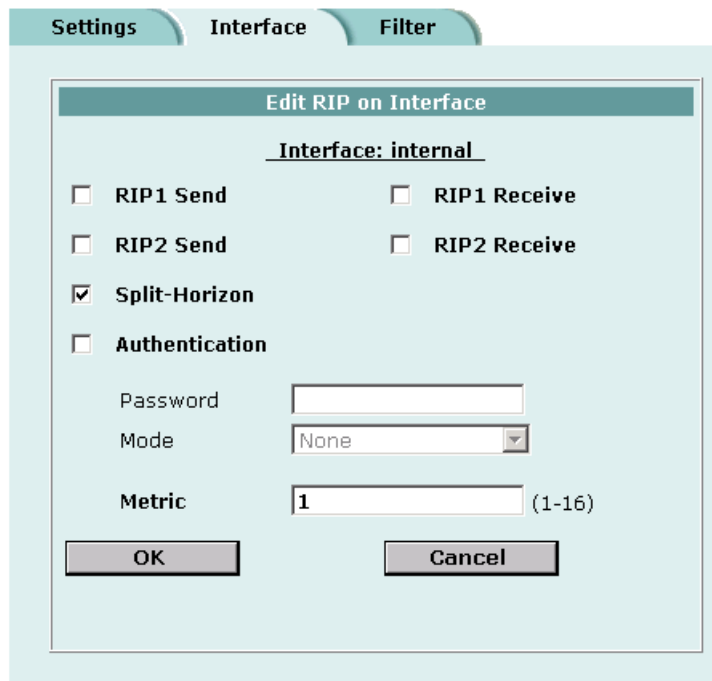

Adding RIP filters

Use the Filter page to create RIP filter lists and assign RIP filter lists to the neighbors filter, incoming route filter, or outgoing route filter. The neighbors filter allows or denies updates from other routers. The incoming filter accepts or rejects routes in an incoming RIP update packet. The outgoing filter allows or denies adding routes to outgoing RIP update packets.

Each entry in a RIP filter list consists of a prefix (IP address and netmask), the action RIP should take for this prefix (allow or deny), and the interface to which to apply this RIP filter list entry. When RIP applies a filter while processing an update packet, it starts at the top of the filter list and works down through the list looking for a matching prefix. If RIP finds a matching prefix, it then checks that the interface in the filter list entry matches the interface that the packet is received or sent on. If both prefix and interface match, RIP takes the action specified. If no match is found, the default action is allow.

- For the neighbors filter, RIP attempts to match prefixes in the filter list against the source address in the update packet.
- For the incoming filter, RIP attempts to match prefixes in the filter list against prefixes in the routing table entries in the update packet.
- For the outgoing filter, RIP attempts to match prefixes in the filter list against prefixes in the RIP routing table.

You can add up to four RIP filter lists to the FortiGate RIP configuration. You can then select one RIP filter list for each RIP filter type: neighbors, incoming routes, outgoing routes. If you do not select a RIP filter list for any of the RIP filter types, no filtering is applied.



Note: To block all updates not specifically allowed in a filter list, create an entry at the bottom of the filter list with a prefix with 0.0.0.0 for the IP address, 0.0.0.0 for the netmask, and action set to deny. Because RIP uses the first match it finds in a top down search of the filter list, all the allowed entries are matched first, and all other entries for the specified interface are matched by the last entry and denied. Create a separate entry at the bottom of the filter list for each interface for which you want to deny all updates not specifically allowed.

This section describes:

- [Adding a RIP filter list](#)
- [Assigning a RIP filter list to the neighbors filter](#)
- [Assigning a RIP filter list to the incoming filter](#)
- [Assigning a RIP filter list to the outgoing filter](#)

Adding a RIP filter list

Each entry in a RIP filter list consists of a prefix (IP address and netmask), the action RIP should take for this prefix (allow or deny), and the interface to which to apply this RIP filter list entry.

To add a RIP filter list

- 1 Go to **System > RIP > Filter**.
- 2 Select New to add a RIP filter.

- 3 For Filter Name, type a name for the RIP filter list.
The name can be 15 characters long and can contain upper and lower case letters, numbers, and special characters. The name cannot contain spaces.
- 4 Select the Blank Filter check box to create a RIP filter list with no entries, or enter the information for the first entry on the RIP filter list.
- 5 Enter the IP address and Mask to create the prefix.
- 6 For Action, select allow or deny.
- 7 For Interface, enter the name of the interface to which to apply the entry.
- 8 Select OK to save the RIP filter list.

To add an entry to a RIP filter list

- 1 Go to **System > RIP > Filter**.
- 2 For the RIP filter list name, select Add Prefix to add an entry to the filter list.
- 3 Enter the IP address and Mask to create the prefix.
- 4 For Action, select allow or deny.
- 5 For Interface, enter the name of the interface to which to apply the entry.
- 6 Select OK to add the entry to the RIP filter list.
- 7 Repeat steps 2 to 6 to add entries to the RIP filter list.

Assigning a RIP filter list to the neighbors filter

The neighbors filter allows or denies updates from other routers. You can assign a single RIP filter list to the neighbors filter.

To assign a RIP filter list to the neighbors filter

- 1 Go to **System > RIP > Filter**.
- 2 Add RIP filter lists as required.
- 3 For Neighbors Filter, select the name of the RIP filter list to assign to the neighbors filter.
- 4 Select Apply.

Assigning a RIP filter list to the incoming filter

The incoming filter accepts or rejects routes in an incoming RIP update packet. You can assign a single RIP filter list to the incoming filter.

To assign a RIP filter list to the incoming filter

- 1 Go to **System > RIP > Filter**.
- 2 Add RIP filter lists as required.
- 3 For Incoming Routes Filter, select the name of the RIP filter list to assign to the incoming filter.
- 4 Select Apply.

Assigning a RIP filter list to the outgoing filter

The outgoing filter allows or denies adding routes to outgoing RIP update packets. You can assign a single RIP filter list to the outgoing filter.

To assign a RIP filter list to the outgoing filter

- 1 Go to **System > RIP > Filter**.
- 2 Add RIP filter lists as required.
- 3 For Outgoing Routes Filter, select the name of the RIP filter list to assign to the outgoing filter.
- 4 Select Apply.

System configuration

Use the System Config page to make any of the following changes to the FortiGate system configuration:

- [Setting system date and time](#)
- [Changing system options](#)
- [Adding and editing administrator accounts](#)
- [Configuring SNMP](#)
- [Replacement messages](#)

Setting system date and time

For effective scheduling and logging, the FortiGate system time must be accurate. You can either manually set the FortiGate system time or you can configure the FortiGate unit to automatically keep its system time correct by synchronizing with a Network Time Protocol (NTP) server.

To set the date and time

- 1 Go to **System > Config > Time**.
- 2 Select Refresh to display the current FortiGate system date and time.
- 3 Select your Time Zone from the list.
- 4 Select the Automatically adjust clock for daylight saving changes check box if you want the FortiGate system clock to be adjusted automatically when your time zone changes to daylight saving time.
- 5 Select Set Time and set the FortiGate system date and time to the correct date and time, if required.
- 6 Select Synchronize with NTP Server to configure the FortiGate unit to use NTP to automatically set the system time and date.

For more information about NTP and to find the IP address of an NTP server that you can use, see <http://www.ntp.org>.

- 7 Enter the IP address or domain name of the NTP server that the FortiGate unit can use to set its time and date.
- 8 Specify how often the FortiGate unit should synchronize its time with the NTP server. A typical Syn Interval would be 1440 minutes for the FortiGate unit to synchronize its time once a day.

- 9 Select Apply.

Figure 49: Example date and time setting

System Time

Time Zone

Automatically adjust clock for daylight saving changes

Set Time Hour Minute Second
 Month Day Year

Synchronize with NTP Server

Server
 Syn Interval (mins)

Changing system options

On the System Config Options page, you can:

- Set the system idle timeout.
- Set the authentication timeout.
- Select the language for the web-base manager.
- Modify the dead gateway detection settings.

To set the system idle timeout

- 1 Go to **System > Config > Options**.
- 2 For Idle Timeout, type a number in minutes.
- 3 Select Apply.

Idle Timeout controls the amount of inactive time that the web-based manager waits before requiring the administrator to log in again.

The default idle time out is 5 minutes. The maximum idle time out is 480 minutes (8 hours).

To set the Auth timeout

- 1 Go to **System > Config > Options**.
- 2 For Auth Timeout, type a number in minutes.

- 3 Select Apply.
Auth Timeout controls the amount of inactive time that the firewall waits before requiring users to authenticate again. For more information, see [“Users and authentication” on page 227](#).
The default Auth Timeout is 15 minutes. The maximum Auth Timeout is 480 minutes (8 hours).

To select a language for the web-based manager

- 1 Go to **System > Config > Options**.
- 2 From the Languages list, select a language for the web-based manager to use.
- 3 Select Apply.
You can choose English, Simplified Chinese, Japanese, Korean, or Traditional Chinese.



Note: When the web-based manager language is set to use Simplified Chinese, Japanese, Korean, or Traditional Chinese, you can change to English by selecting the English button on the upper right of the web-based manager.

Modifying the Dead Gateway Detection settings

Modify dead gateway detection to control how the FortiGate unit confirms connectivity with a ping server added to an interface configuration. For information about adding a ping server to an interface, see [“Adding a ping server to an interface” on page 146](#).

To modify the dead gateway detection settings

- 1 Go to **System > Config > Options**.
- 2 For Detection Interval, type a number in seconds to specify how often the FortiGate unit tests the connection to the ping target.
- 3 For Fail-over Detection, type a number of times that the connection test fails before the FortiGate unit assumes that the gateway is no longer functioning.
- 4 Select Apply.

Adding and editing administrator accounts

When the FortiGate unit is initially installed, it is configured with a single administrator account with the user name admin. From this administrator account, you can add and edit administrator accounts. You can also control the access level of each of these administrator accounts and control the IP address from which the administrator can connect to the FortiGate unit.

There are three administration account access levels:

admin	Has all permissions. Can view, add, edit, and delete administrator accounts. Can view and change the FortiGate configuration. The admin user is the only user who can go to the System Status page and manually update firmware, update the antivirus definitions, update the attack definitions, download or upload system settings, restore the FortiGate unit to factory defaults, restart the FortiGate unit, and shut down the FortiGate unit. There is only one admin user.
Read & Write	Can view and change the FortiGate configuration. Can view but cannot add, edit, or delete administrator accounts. Can change own administrator account password. Cannot make changes to system settings from the System Status page.
Read Only	Can view the FortiGate configuration.

Adding new administrator accounts

From the admin account, use the following procedure to add new administrator accounts and control their permission levels.

To add an administrator account



- 1 Go to **System > Config > Admin**.
- 2 Select New to add an administrator account.
- 3 Type a login name for the administrator account.
The login name can contain numbers (0-9), uppercase and lowercase letters (A-Z, a-z), and the special characters - and _. Other special characters and spaces are not allowed.
- 4 Type and confirm a password for the administrator account.
For improved security, the password should be at least 6 characters long. The password can contain any characters except spaces.
- 5 Optionally type a Trusted Host IP address and netmask for the location from which the administrator can log into the web-based manager.
If you want the administrator to be able to access the FortiGate unit from any address, set the trusted host to 0.0.0.0 and the netmask to 0.0.0.0.
To limit the administrator to only access the FortiGate unit from a specific network, set the trusted host to the address of the network and set the netmask to the netmask for the network. For example, to limit an administrator to accessing the FortiGate unit from your internal network, set the trusted host to the address of your internal network (for example, 192.168.1.0) and set the netmask to 255.255.255.0.
- 6 Set the Permission level for the administrator.
- 7 Select OK to add the administrator account.

Editing administrator accounts

The admin account user can change individual administrator account passwords, configure the IP addresses from which administrators can access the web-based manager, and change the administrator permission levels.

Administrator account users with Read & Write access can change their own administrator passwords.

To edit an administrator account

- 1 Go to **System > Config > Admin**.
- 2 To change an administrator account password, select Change Password .
- 3 Type the Old Password.
- 4 Type and confirm a new password.
For improved security, the password should be at least 6 characters long. The password can contain any characters except spaces. If you enter a password that is less than 6 characters long, the system displays a warning message but still accepts the password.
- 5 Select OK.
- 6 To edit the settings of an administrator account, select Edit .
- 7 Optionally type a Trusted Host IP address and netmask for the location from which the administrator can log into the web-based manager.
If you want the administrator to be able to access the FortiGate unit from any address, set the trusted host to 0.0.0.0 and the netmask to 255.255.255.255.
To limit the administrator to only be able to access the FortiGate unit from a specific network, set the trusted host to the address of the network and set the netmask to the netmask for the network. For example, to limit an administrator to accessing the FortiGate unit from your internal network, set the trusted host to the address of your internal network (for example, 192.168.1.0) and set the netmask to 255.255.255.0.
- 8 Change the administrator's permission level as required.
- 9 Select OK.
- 10 To delete an administrator account, choose the account to delete and select Delete .

Configuring SNMP

You can configure the FortiGate SNMP agent to report system information and send traps to SNMP managers. Using an SNMP manager, you can access SNMP traps and data from any FortiGate interface or VLAN subinterface configured for SNMP management access.

The FortiGate SNMP implementation is read-only. SNMP v1 and v2c compliant SNMP managers have read-only access to FortiGate system information and can receive FortiGate traps. To monitor FortiGate system information and receive FortiGate traps you must compile Fortinet proprietary MIBs as well as Fortinet-supported standard MIBs into your SNMP manager.

RFC support includes support for most of RFC 2665 (Ethernet-like MIB) and most of RFC 1213 (MIB II) (for more information, see [FortiGate MIBs](#)).

This section describes:

- [Configuring the FortiGate unit for SNMP monitoring](#)
- [Configuring FortiGate SNMP support](#)
- [FortiGate MIBs](#)
- [FortiGate traps](#)
- [Fortinet MIB fields](#)

Configuring the FortiGate unit for SNMP monitoring

Before a remote SNMP manager can connect to the FortiGate agent, you must configure one or more FortiGate interfaces to accept SNMP connections. See [“Controlling administrative access to an interface” on page 147](#).

Configuring FortiGate SNMP support

Use the information in this section to configure the FortiGate unit so that an SNMP manager can connect to the FortiGate SNMP agent to receive management information and traps.

- [Configuring SNMP access to an interface](#)
- [Configuring SNMP community settings](#)

Configuring SNMP access to an interface

Before a remote SNMP manager can connect to the FortiGate agent, you must configure one or more FortiGate interface's to accept SNMP connections. The configuration steps to follow depend on whether the FortiGate unit is operating in NAT/Route mode or Transparent mode.

To configure SNMP access to an interface in NAT/Route mode

- 1 Go to **System > Network > Interface**.
- 2 Choose the interface that the SNMP manager connects to and select Modify .
- 3 For Administrative Access select SNMP.
- 4 Select OK.

To configure SNMP access to an interface in Transparent mode

- 1 Go to **System > Network > Management**.
- 2 Choose the interface that the SNMP manager connects to and select SNMP.
Select Apply.

Configuring SNMP community settings

You can configure a single SNMP community for each FortiGate device. An SNMP community consists of identifying information about the FortiGate unit, your SNMP get community and trap community strings, and the IP addresses of up to three SNMP managers that can receive traps sent by the FortiGate SNMP agent.

To configure SNMP community settings

- 1 Go to **System > Config > SNMP v1/v2c**.
- 2 Select the Enable SNMP check box.
- 3 Configure the following SNMP settings:

System Name	Automatically set to the FortiGate host name. To change the System Name, see “Changing the FortiGate host name” on page 102 .
System Location	Describe the physical location of the FortiGate unit. The system location description can be up to 31 characters long and can contain spaces, numbers (0-9), uppercase and lowercase letters (A-Z, a-z), and the special characters - and _. The \ < > [] ` \$ % & characters are not allowed.
Contact Information	Add the contact information for the person responsible for this FortiGate unit. The contact information can be up to 31 characters long and can contain spaces, numbers (0-9), uppercase and lowercase letters (A-Z, a-z), and the special characters - and _. The \ < > [] ` \$ % & characters are not allowed.
Get Community	Also called read community, get community is a password to identify SNMP get requests sent to the FortiGate unit. When an SNMP manager sends a get request to the FortiGate unit, it must include the correct get community string. The default get community string is “public”. Change the default get community string to keep intruders from using get requests to retrieve information about your network configuration. The get community string must be used in your SNMP manager to enable it to access FortiGate SNMP information. The get community string can be up to 31 characters long and can contain numbers (0-9), uppercase and lowercase letters (A-Z, a-z), and the special characters - and _. Spaces and the \ < > [] ` \$ % & characters are not allowed.
Trap Community	The trap community string functions like a password that is sent with SNMP traps. The default trap community string is “public”. Change the trap community string to the one accepted by your trap receivers. The trap community string can be up to 31 characters long and can contain numbers (0-9), uppercase and lowercase letters (A-Z, a-z), and the special characters - and _. Spaces and the \ < > [] ` \$ % & characters are not allowed.
Trap Receiver IP Addresses	Type the IP addresses of up to three trap receivers on your network that are configured to receive traps from your FortiGate unit. Traps are only sent to the configured addresses.

- 4 Select Apply.

Figure 50: Sample SNMP configuration

FortiGate MIBs

The FortiGate SNMP agent supports FortiGate proprietary MIBs as well as standard RFC 1213 and RFC 2665 MIBs. The FortiGate MIBs are listed in [Table 28](#). You can obtain these MIB files from Fortinet technical support. To be able to communicate with the SNMP agent, you must compile all of these MIBs into your SNMP manager.

Your SNMP manager might already include standard and private MIBs in a compiled database that is ready to use. You must add the Fortinet proprietary MIBs to this database. If the standard MIBs used by the Fortinet SNMP agent are already compiled into your SNMP manager you do not have to compile them again.

Table 28: FortiGate MIBs

MIB file name or RFC	Description
fortinet-trap.mib	The Fortinet trap MIB is a proprietary MIB that is required for your SNMP manager to receive traps from the FortiGate SNMP agent. For more information about FortiGate traps, see “FortiGate traps” on page 183 .
fortinet.mib	The Fortinet MIB is a proprietary MIB that includes detailed FortiGate system configuration information. Add this MIB to your SNMP manager to monitor all FortiGate configuration settings.
RFC-1213 (MIB II)	<p>The FortiGate SNMP agent supports MIB II groups with the following exceptions.</p> <p>No support for the EGP group from MIB II (RFC 1213, section 3.11 and 6.10).</p> <p>Protocol statistics returned for MIB II groups (IP/ICMP/TCP/UDP/etc.) do not accurately capture all FortiGate traffic activity. More accurate information can be obtained from the information reported by the Fortinet MIB.</p>
RFC-2665 (Ethernet-like MIB)	<p>The FortiGate SNMP agent supports Ethernet-like MIB information with the following exception.</p> <p>No support for the dot3Tests and dot3Errors groups.</p>

FortiGate traps

The FortiGate agent can send traps to up to three SNMP trap receivers on your network that are configured to receive traps from the FortiGate unit. For these SNMP managers to receive traps, you must load and compile the Fortinet trap MIB onto the SNMP manager.

General FortiGate traps

Table 29: General FortiGate traps

Trap message	Description
Cold Start	The FortiGate unit starts or restarts. An administrator enables the SNMP agent or changes FortiGate SNMP settings. This trap is sent when the agent starts during system startup.
System Down	The SNMP agent stops because the FortiGate unit shuts down.
Agent Down	An administrator disables the SNMP agent.
Agent Up	An administrator enables the SNMP agent. This trap is also sent when the agent starts during system startup.
The <interface_name> Interface IP is changed to <new_IP> (Serial No.: <FortiGate_serial_no>)	The IP address of an interface of a FortiGate unit changes. The trap message includes the name of the interface, the new IP address of the interface, and the serial number of the FortiGate unit. This trap can be used to track interface IP address changes for interfaces configured with dynamic IP addresses set using DHCP or PPPoE.

System traps

Table 30: FortiGate system traps

Trap message	Description
interface <interface_name> is up.	An interface changes from the up state to the running state, indicating that the interface has been connected to a network. When the interface is up it is administratively up but not connected to a network. When the interface is running it is administratively up and connected to a network.
interface <interface_name> is down.	An interface changes from the running state to the up state, indicating that the interface has been disconnected from a network.
CPU usage high	CPU usage exceeds 90%.
memory low	Memory usage exceeds 90%.
disk low	On a FortiGate unit with a hard drive, hard drive usage exceeds 90%.
<FortiGate_serial_no> <interface_name>	The configuration of an interface of a FortiGate unit changes. The trap message includes the name of the interface and the serial number of the FortiGate unit.
HA switch	The primary unit in an HA cluster fails and is replaced with a new primary unit.

VPN traps

Table 31: FortiGate VPN traps

Trap message	Description
VPN tunnel is up	An IPSec VPN tunnel starts up and begins processing network traffic.
VPN tunnel down	An IPSec VPN tunnel shuts down.

NIDS traps

Table 32: FortiGate NIDS traps

Trap message	Description
Flood attack happened.	NIDS attack prevention detects and provides protection from a syn flood attack.
Port scan attack happened.	NIDS attack prevention detects and provides protection from a port scan attack.

Antivirus traps

Table 33: FortiGate antivirus traps

Trap message	Description
virus detected	The FortiGate unit detects a virus and removes the infected file from an HTTP or FTP download or from an email message.

Logging traps

Table 34: FortiGate logging traps

Trap message	Description
log full	On a FortiGate unit with a hard drive, hard drive usage exceeds 90%. On a FortiGate unit without a hard drive, log to memory usage has exceeds 90%.

Fortinet MIB fields

The Fortinet MIB contains fields for configuration settings and current status information for all parts of the FortiGate product. This section lists the names of the high-level MIB fields and describes the configuration and status information available for each one. You can view more details about the information available from all Fortinet MIB fields by compiling the `fortinet.mib` file into your SNMP manager and browsing the Fortinet MIB fields.

System configuration and status

Table 35: System MIB fields

MIB field	Description
fnSysStatus	FortiGate system configuration including operation mode, firmware version, virus definition version, attack definition version, and serial number. Status monitor information including current CPU usage, CPU idle status, CPU interrupts, memory usage, system up time, the number of active communication sessions, as well as descriptive information for each active communication session.
fnSysUpdate	FortiGate system update configuration including connection status to the FDN, push update status, periodic update status, and current virus and attack definitions versions.
fnSysNetwork	FortiGate system network configuration including the interface, VLAN, routing, DHCP, zone, and DNS configuration.
fnSysConfig	FortiGate system configuration including time, options, administrative users, and HA configuration.
fnSysSnmp	FortiGate SNMP configuration.

Firewall configuration

Table 36: Firewall MIB fields

MIB field	Description
fnFirewallPolicy	FortiGate firewall policy list including complete configuration information for each policy.
fnFirewallAddress	FortiGate firewall address and address group list.
fnFirewallService	FortiGate firewall service and service group list.
fnFirewallSchedule	FortiGate firewall schedule list.
fnFirewallVirtualIP	FortiGate firewall virtual IP list.
fnFirewallIpPool	FortiGate firewall IP pool list.
fnFirewallIPMACBinding	FortiGate firewall IP/MAC binding configuration.
fnFirewallContProfiles	FortiGate firewall content profile list.

Users and authentication configuration

Table 37: User and authentication MIB fields

FnUserLocalTable	Local user list.
FnUserRadiusSrvTable	RADIUS server list.
FnUserGrpTable	User group list.

VPN configuration and status

Table 38: VPN MIB fields

fnVpnIpsec	IPSec VPN configuration including the Phase 1 list, Phase 2 list, manual key list, and VPN concentrator list. Status and timeout for each VPN tunnel (Phase 2) and the dialup monitor list showing dialup tunnel status.
fnVpnPPTP	PPTP VPN configuration.
fnVpnL2TP	L2TP VPN configuration.
fnVpnCert	IPSec VPN with certificates configuration.

NIDS configuration

Table 39: NIDS MIB fields

fnNidsDetection	NIDS detection configuration.
fnNidsPrevention	NIDS prevention configuration.
fnNidsResponse	NIDS response configuration.

Antivirus configuration

Table 40: Antivirus MIB fields

fnAvFileBlock	Antivirus file blocking configuration.
fnAvQuarantine	Antivirus quarantine configuration.
fnAVConfig	Antivirus configuration including the current virus definition virus list.

Web filter configuration

Table 41: Web filter MIB fields

fnWebFiltercfgMsgTable	Web filter content block list and configuration.
fnWebFilterUrlBlk	Web filter URL block list.
fnWebFilterScripts	Web filter script blocking configuration.
fnWebFilterExemptUrl	Web filter exempt URL list.

Logging and reporting configuration

Table 42: Logging and reporting MIB fields

fnLoglogSetting	Log setting configuration.
fnLoglog	Log setting traffic filter configuration.
fnLogAlertEmail	Alert email configuration.

Replacement messages

Replacement messages are added to content passing through the firewall to replace:

- Files or other content removed from POP3 and IMAP email messages by the antivirus system,
- Files or other content removed from HTTP downloads by the antivirus system or web filtering,
- Files removed from FTP downloads by the antivirus system.

You can edit the content of replacement messages.

You can also edit the content added to alert email messages to control the information that appears in alert emails for virus incidents, NIDS events, critical system events, and disk full events.

This section describes:

- [Customizing replacement messages](#)
- [Customizing alert emails](#)

Figure 51: Sample replacement message

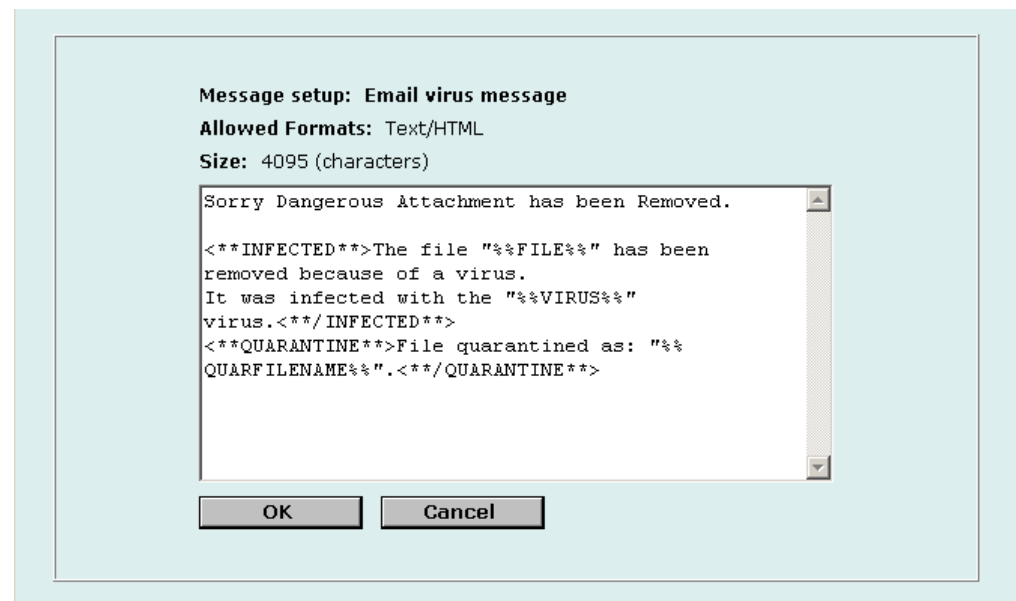

Customizing replacement messages

Each of the replacement messages in the replacement message list is created by combining replacement message sections. You can use these sections as building blocks to create your own replacement messages.

You can edit any of the replacement messages in the replacement message list and add and edit the replacement message sections as required.

To customize a replacement message

- 1 Go to **System > Config > Replacement Messages**.
- 2 For the replacement message that you want to customize, select Modify .
- 3 In the Message setup dialog box, edit the content of the message.
[Table 43](#) lists the replacement message sections that can be added to replacement messages and describes the tags that can appear in each section. In addition to the allowed tags you can add text. For mail and HTTP messages you can also add HTML code.
- 4 Select OK to save the changes.

Table 43: Replacement message sections

File blocking	Used for file blocking (all services).	
Section Start	< **BLOCKED** >	
Allowed Tags	%%FILE%%	The name of the file that was blocked.
	%%URL%%	The URL of the blocked web page.
Section End	< **/BLOCKED** >	

Scanning	Used for virus scanning (all services).	
Section Start	< **INFECTED** >	
Allowed Tags	%%FILE%%	The name of the file that was infected.
	%%VIRUS%%	The name of the virus infecting the file.
	%%URL%%	The URL of the blocked web page or file.
Section End	< **/INFECTED** >	

Quarantine	Used when quarantine is enabled (permitted for all scan services and block services for email only).	
Section Start	< **QUARANTINE** >	
Allowed Tag	%%QUARFILE NAME%%	The name of the file that was quarantined.
Section End	< **/QUARANTINE** >	

Customizing alert emails

Customize alert emails to control the content displayed in alert email messages sent to system administrators.

To customize alert emails

- 1 Go to **System > Config > Replacement Messages**.
- 2 For the alert email message that you want to customize, select Modify .
- 3 In the Message setup dialog box, edit the text of the message.
Table 44 lists the replacement message sections that can be added to alert email messages and describes the tags that can appear in each section. In addition to the allowed tags you can add text and HTML code.
- 4 Select OK to save the changes.

Table 44: Alert email message sections

NIDS event	Used for NIDS event alert email messages	
Section Start	<NIDS_EVENT>	
Allowed Tags	%%NIDS_EVENT%%	The NIDS attack message.
Section End	</NIDS_EVENT>	

Virus alert	Used for virus alert email messages	
Section Start	<VIRUS_ALERT>	
Allowed Tags	%%VIRUS%%	The name of the virus.
	%%PROTOCOL%%	The service for which the virus was detected.
	%%SOURCE_IP%%	The IP address from which the virus was received. For email this is the IP address of the email server that sent the email containing the virus. For HTTP this is the IP address of web page that sent the virus.
	%%DEST_IP%%	The IP address of the computer that would have received the virus. For POP3 this is the IP address of the user's computer that attempted to download the email containing the virus.
	%%EMAIL_FROM%%	The email address of the sender of the message in which the virus was found.
	%%EMAIL_TO%%	The email address of the intended receiver of the message in which the virus was found.
Section End	</VIRUS_ALERT>	

Block alert	Used for file block alert email messages	
Section Start	<BLOCK_ALERT>	
Allowed Tags	%%FILE%%	The name of the file that was blocked.
	%%PROTOCOL%%	The service for which the file was blocked.

Table 44: Alert email message sections

	%%SOURCE_IP%%	The IP address from which the block file was received. For email this is the IP address of the email server that sent the email containing the blocked file. For HTTP this is the IP address of web page that sent the blocked file.
	%%DEST_IP%%	The IP address of the computer that would have received the blocked file. For email this is the IP address of the user's computer that attempted to download the message from which the file were removed.
	%%EMAIL_FROM%%	The email address of the sender of the message from which the file was removed.
	%%EMAIL_TO%%	The email address of the intended receiver of the message from which the file was removed.
Section End	<*/BLOCK_ALERT*>	

Critical event	Used for critical firewall event alert emails.	
Section Start	<*/CRITICAL_EVENT*>	
Allowed Tags	%%CRITICAL_EVENT %%	The firewall critical event message
Section End	<*/CRITICAL_EVENT*>	

Firewall configuration

Firewall policies control all traffic passing through the FortiGate unit. Firewall policies are instructions that the FortiGate unit uses to decide what to do with a connection request. When the firewall receives a connection request in the form of a packet, it analyzes the packet to extract its source address, destination address, and service (port number).

For the packet to be connected through the FortiGate unit, a firewall policy must be in place that matches the source address, destination address, and service of the packet. The policy directs the firewall action on the packet. The action can be to allow the connection, deny the connection, require authentication before the connection is allowed, or process the packet as an IPSec VPN packet. You can also add schedules to policies so that the firewall can process connections differently depending on the time of day or the day of the week, month, or year.

Each policy can be individually configured to route connections or apply network address translation (NAT) to translate source and destination IP addresses and ports. You can add IP pools to use dynamic NAT when the firewall translates source addresses. You can use policies to configure port address translation (PAT) through the FortiGate.

You can add content profiles to policies to apply antivirus protection, web filtering, and email filtering to web, file transfer, and email services. You can create content profiles that perform one or any combination of the following actions:

- Apply antivirus protection to HTTP, FTP, SMTP, IMAP, or POP3 services.
- Apply web filtering to HTTP services.
- Apply email filtering to IMAP and POP3 services.

You can also add logging to a firewall policy so that the FortiGate unit logs all connections that use this policy.

This chapter describes:

- [Default firewall configuration](#)
- [Adding firewall policies](#)
- [Configuring policy lists](#)
- [Addresses](#)
- [Services](#)
- [Schedules](#)
- [Virtual IPs](#)
- [IP pools](#)

- [IP/MAC binding](#)
- [Content profiles](#)

Default firewall configuration

By default, the users on your internal network can connect through the FortiGate unit to the Internet. The firewall blocks all other connections. The firewall is configured with a default policy that matches any connection request received from the internal network and instructs the firewall to forward the connection to the Internet.

The default policy also applies virus scanning to all HTTP, FTP, SMTP, POP3, and IMAP traffic matched by the policy. The policy applies virus scanning because the Antivirus & Web Filter option is selected and the Content profile is set to Scan. For more information about content profiles, see [“Content profiles” on page 223](#).

Figure 52: Default firewall policy

#	ID	Source	Dest	Schedule	Service	Action	Enable	Config
1	1	Internal_All	External_All	Always	ANY	ACCEPT	<input checked="" type="checkbox"/>	

- [Interfaces](#)
- [VLAN subinterfaces](#)
- [Zones](#)
- [Addresses](#)
- [Services](#)
- [Schedules](#)
- [Content profiles](#)

Interfaces

Add policies to control connections between FortiGate interfaces and between the networks connected to these interfaces. By default, you can add policies for connections that include the internal and external interfaces.

Use the following steps to add an interface to the firewall policy grid. You would have to add an interface to the policy grid if you previously removed it from the policy grid to add it to a zone.

- 1 If they are down, start the interfaces up.
See [“Changing the administrative status of an interface” on page 143](#).
- 2 Add IP addresses to the interfaces.
See [“Configuring interfaces” on page 142](#).
- 3 Add firewall addresses for these interfaces.
See [“Adding addresses” on page 202](#).

VLAN subinterfaces

You can also add VLAN subinterfaces to the FortiGate configuration to control connections between VLANs. For more information about VLANs, see [“VLANs in NAT/Route mode” on page 151](#) or [“Virtual domains in Transparent mode” on page 153](#).

To add policies that include VLAN subinterfaces, you must use the following steps to add the VLAN subinterfaces to the firewall policy grid:

- 1 Add VLAN subinterfaces to the FortiGate configuration.
- 2 Add firewall addresses for the VLAN subinterface.
See [“Adding addresses” on page 202](#).

Zones

You can add zones to the FortiGate configuration to group together related interfaces and VLAN subinterfaces to simplify firewall policy creation. For more information about zones, see [“Configuring zones” on page 141](#).

To add policies for zones, you must use the following steps to add the zones to the firewall policy grid:

- 1 Add zones to the FortiGate configuration.
See [“Adding zones” on page 142](#).
- 2 Add interfaces and VLAN subinterfaces to the zone.
See [“Adding an interface to a zone” on page 143](#).
- 3 Add firewall addresses for the zone.
See [“Adding addresses” on page 202](#).

Addresses

To add policies between interfaces, VLAN subinterfaces and zones, the firewall configuration must contain addresses for each interface, VLAN subinterface, or zone. By default the firewall configuration includes the addresses listed in [Table 45](#).

Table 45: Default addresses

Interface	Address	Description
Internal	Internal_All	This address matches all addresses on the internal network.
External	External_All	This address matches all addresses on the external network.

The firewall uses these addresses to match the source and destination addresses of packets received by the firewall. The default policy matches all connections from the internal network because it includes the Internal_All address. The default policy also matches all connections to the Internet because it includes the External_All address.

You can add more addresses to each interface to improve the control you have over connections through the firewall. For more information about addresses, see [“Addresses” on page 202](#).

You can also add firewall policies that perform network address translation (NAT). To use NAT to translate destination addresses, you must add virtual IPs. Virtual IPs map addresses on one network to a translated address on another network. For more information about Virtual IPs, see [“Virtual IPs” on page 213](#).

Services

Policies can control connections based on the service or destination port number of packets. The default policy accepts connections using any service or destination port number. The firewall is configured with over 40 predefined services. You can add these services to a policy for more control over the services that can be used by connections through the firewall. You can also add user-defined services. For more information about services, see [“Services” on page 205](#).

Schedules

Policies can control connections based on the time of day or day of the week when the firewall receives the connection. The default policy accepts connections at any time. The firewall is configured with one schedule that accepts connections at any time. You can add more schedules to control when policies are active. For more information about schedules, see [“Schedules” on page 210](#).

Content profiles

Add content profiles to policies to apply antivirus protection, web filtering, and email filtering to web, file transfer, and email services. The FortiGate unit includes the following default content profiles:

- **Strict**—to apply maximum content protection to HTTP, FTP, IMAP, POP3, and SMTP content traffic.
- **Scan**—to apply antivirus scanning to HTTP, FTP, IMAP, POP3, and SMTP content traffic.
- **Web**—to apply antivirus scanning and Web content blocking to HTTP content traffic.
- **Unfiltered**—to allow oversized files to pass through the FortiGate unit without scanned for viruses.

The default policy includes the scan content profile.

For more information about content profiles, see [“Content profiles” on page 223](#).

Adding firewall policies

Add Firewall policies to control connections and traffic between FortiGate interfaces, zones, and VLAN subinterfaces.

To add a firewall policy

- 1 Go to **Firewall > Policy**.
- 2 Select the policy list to which you want to add the policy.

- 3 Select New to add a new policy.
You can also select Insert Policy before  on a policy in the list to add the new policy above a specific policy.
- 4 Configure the policy:
For information about configuring the policy, see [“Firewall policy options” on page 196](#).
- 5 Select OK to add the policy.
- 6 Arrange policies in the policy list so that they have the results that you expect.
For information about arranging policies in a policy list, see [“Configuring policy lists” on page 200](#).

Figure 53: Adding a NAT/Route policy

Policy

Edit Policy internal -> external

Source: Internal_All

Destination: External_All

Schedule: Always

Service: ANY

Action: ACCEPT

NAT

Dynamic IP Pool:

Fixed Port:

Traffic Shaping

Guaranteed Bandwidth: 100 (KBytes/s)

Maximum Bandwidth: 100 (KBytes/s)

Traffic Priority: High

Authentication

User Group: User_Group_1

Anti-Virus & Web filter

Content Profile: Scan

Log Traffic

Comments: maximum 63 characters

Policy: Traffic Shaping, Authentication, and Virus Scanning

OK Cancel

Firewall policy options

This section describes the options that you can add to firewall policies.

Source

Select an address or address group that matches the source address of the packet. Before you can add this address to a policy, you must add it to the source interface. For information about adding an address, see [“Addresses” on page 202](#).

Destination

Select an address or address group that matches the destination address of the packet. Before you can add this address to a policy, you must add it to the destination interface, VLAN subinterface, or zone. For information about adding an address, see [“Addresses” on page 202](#).

For NAT/Route mode policies where the address on the destination network is hidden from the source network using NAT, the destination can also be a virtual IP that maps the destination address of the packet to a hidden destination address. See [“Virtual IPs” on page 213](#).

Schedule

Select a schedule that controls when the policy is available to be matched with connections. See [“Schedules” on page 210](#).

Service

Select a service that matches the service (port number) of the packet. You can select from a wide range of predefined services or add custom services and service groups. See [“Services” on page 205](#).

Action

Select how you want the firewall to respond when the policy matches a connection attempt.

ACCEPT	Accept the connection. If you select ACCEPT, you can also configure NAT and Authentication for the policy.
DENY	Deny the connection. The only other policy option that you can configure is Log Traffic, to log the connections denied by this policy.
ENCRYPT	Make this policy an IPSec VPN policy. If you select ENCRYPT, you can select an AutoIKE Key or Manual Key VPN tunnel for the policy and configure other IPSec settings. You cannot add authentication to an ENCRYPT policy. ENCRYPT is not available in Transparent mode. See “Configuring encrypt policies” on page 249 .

NAT

Configure the policy for NAT. NAT translates the source address and the source port of packets accepted by the policy. If you select NAT, you can also select Dynamic IP Pool and Fixed Port. NAT is not available in Transparent mode.

Dynamic IP Pool Select Dynamic IP Pool to translate the source address to an address randomly selected from an IP pool. The IP pool must be added to the destination interface or VLAN subinterface of the policy or to an interface or VLAN subinterface in the destination zone of the policy.

You cannot select Dynamic IP Pool if the destination interface or VLAN subinterface is configured using DHCP or PPPoE.

For information about adding IP pools, see [“IP pools” on page 218](#).

Fixed Port Select Fixed Port to prevent NAT from translating the source port. Some applications do not function correctly if the source port is changed. If you select Fixed Port, you must also select Dynamic IP Pool and add a dynamic IP pool address range to the destination interface of the policy. If you do not select Dynamic IP Pool, a policy with Fixed Port selected can only allow one connection at a time for this port or service.

VPN Tunnel

Select a VPN tunnel for an ENCRYPT policy. You can select an AutoIKE key or Manual Key tunnel. VPN Tunnel is not available in Transparent mode.

Allow inbound Select Allow inbound so that users behind the remote VPN gateway can connect to the source address.

Allow outbound Select Allow outbound so that users can connect to the destination address behind the remote VPN gateway.

Inbound NAT Select Inbound NAT to translate the source address of incoming packets to the FortiGate internal IP address.

Outbound NAT Select Outbound NAT to translate the source address of outgoing packets to the FortiGate external IP address.

Traffic Shaping

Traffic Shaping controls the bandwidth available to and sets the priority of the traffic processed by the policy. Traffic Shaping makes it possible to control which policies have the highest priority when large amounts of data are moving through the FortiGate device. For example, the policy for the corporate web server might be given higher priority than the policies for most employees' computers. An employee who needs unusually high-speed Internet access could have a special outgoing policy set up with higher bandwidth.

If you set both guaranteed bandwidth and maximum bandwidth to 0 the policy does not allow any traffic.

Guaranteed Bandwidth	You can use traffic shaping to guarantee the amount of bandwidth available through the firewall for a policy. Guarantee bandwidth (in Kbytes) to make sure that there is enough bandwidth available for a high-priority service.
Maximum Bandwidth	You can also use traffic shaping to limit the amount of bandwidth available through the firewall for a policy. Limit bandwidth to keep less important services from using bandwidth needed for more important services.
Traffic Priority	Select High, Medium, or Low. Select Traffic Priority so that the FortiGate unit manages the relative priorities of different types of traffic. For example, a policy for connecting to a secure web server needed to support e-commerce traffic should be assigned a high traffic priority. Less important services should be assigned a low priority. The firewall provides bandwidth to low-

Authentication

Select Authentication and select a user group to require users to enter a user name and password before the firewall accepts the connection. Select the user group to control the users that can authenticate with this policy. For information about adding and configuring user groups, see [“Configuring user groups” on page 232](#). You must add user groups before you can select Authentication.

You can select Authentication for any service. Users can authenticate with the firewall using HTTP, Telnet, or FTP. For users to be able to authenticate you must add an HTTP, Telnet, or FTP policy that is configured for authentication. When users attempt to connect through the firewall using this policy they are prompted to enter a firewall username and password.

If you want users to authenticate to use other services (for example POP3 or IMAP) you can create a service group that includes the services for which you want to require authentication, as well as HTTP, Telnet, and FTP. Then users could authenticate with the policy using HTTP, Telnet, or FTP before using the other service.

In most cases you should make sure that users can use DNS through the firewall without authentication. If DNS is not available users cannot connect to a web, FTP, or Telnet server using a domain name.

Anti-Virus & Web filter

Enable antivirus protection and web filter content filtering for traffic controlled by this policy. You can select Anti-Virus & Web filter if Service is set to ANY, HTTP, SMTP, POP3, IMAP, or FTP or to a service group that includes the HTTP, SMTP, POP3, IMAP, or FTP services.

Select a content profile to configure how antivirus protection and content filtering is applied to the policy. For information about selecting a content profile, see [“Content profiles” on page 223](#).

Figure 54: Adding a Transparent mode policy

Policy

Edit Policy internal -> external

Source: Internal_All

Destination: External_All

Schedule: Always

Service: ANY

Action: ACCEPT

Traffic Shaping

Guaranteed Bandwidth: 100 (KBytes/s)

Maximum Bandwidth: 100 (KBytes/s)

Traffic Priority: Medium

Authentication

User_Group_1

Anti-Virus & Web filter

Content Profile: Scan

Log Traffic

Comments: maximum 63 characters

Policy: Traffic Shaping, Authentication, and Virus Scanning

OK Cancel

Log Traffic

Select Log Traffic to write messages to the traffic log whenever the policy processes a connection. For information about logging, see [“Logging and reporting” on page 307](#).

Comments

You can add a description or other information about the policy. The comment can be up to 63 characters long, including spaces.

Configuring policy lists

The firewall matches policies by searching for a match starting at the top of the policy list and moving down until it finds the first match. You must arrange policies in the policy list from more specific to more general.

For example, the default policy is a very general policy because it matches all connection attempts. When you create exceptions to that policy, you must add them to the policy list above the default policy. No policy below the default policy will ever be matched.

This section describes:

- [Policy matching in detail](#)
- [Changing the order of policies in a policy list](#)
- [Enabling and disabling policies](#)

Policy matching in detail

When the FortiGate unit receives a connection attempt at an interface, it must select a policy list to search through for a policy that matches the connection attempt. The FortiGate unit chooses the policy list based on the source and destination addresses of the connection attempt.

The FortiGate unit then starts at the top of the selected policy list and searches down the list for the first policy that matches the connection attempt source and destination addresses, service port, and time and date at which the connection attempt was received. The first policy that matches is applied to the connection attempt. If no policy matches, the connection is dropped.

The default policy accepts all connection attempts from the internal network to the Internet. From the internal network, users can browse the web, use POP3 to get email, use FTP to download files through the firewall, and so on. If the default policy is at the top of the internal->external policy list, the firewall allows all connections from the internal network to the Internet because all connections match the default policy. If more specific policies are added to the list below the default policy, they are never matched.

A policy that is an exception to the default policy, for example, a policy to block FTP connections, must be placed above the default policy in the internal->external policy list. In this example, all FTP connection attempts from the internal network would then match the FTP policy and be blocked. Connection attempts for all other kinds of services would not match with the FTP policy but they would match with the default policy. Therefore, the firewall would still accept all other connections from the internal network.



Note: Policies that require authentication must be added to the policy list above matching policies that do not; otherwise, the policy that does not require authentication is selected first.

Changing the order of policies in a policy list

To change the order of a policy in a policy list

- 1 Go to **Firewall > Policy**.
- 2 Select the policy list that you want to change the order of.
- 3 Choose the policy that you want to move and select Move To  to change its order in the policy list.
- 4 Type a number in the Move to field to specify where in the policy list to move the policy and select OK.

Enabling and disabling policies

You can enable and disable policies in the policy list to control whether the policy is active or not. The FortiGate unit matches enabled policies but does not match disabled policies.

Disabling policies

Disable a policy to temporarily prevent the firewall from selecting the policy. Disabling a policy does not stop active communications sessions that have been allowed by the policy. For information about stopping active communication sessions, see [“System status” on page 118](#).

To disable a policy

- 1 Go to **Firewall > Policy**.
- 2 Select the policy list that contains the policy that you want to disable.
- 3 Clear the check box of the policy to disable it.

Enabling policies

Enable a policy that has been disabled so that the firewall can match connections with the policy.

To enable a policy

- 1 Go to **Firewall > Policy**.
- 2 Select the policy list that contains the policy that you want to enable.
- 3 Select the check box of the policy to enable it.

Addresses

All policies require source and destination addresses. To add addresses to a policy, you must first add addresses to the address list for the interfaces, zones, or VLAN subinterfaces of the policy.

You can add, edit, and delete all firewall addresses as required. You can also organize related addresses into address groups to simplify policy creation.

A firewall address consists of an IP address and a netmask. This information can represent:

- The address of a subnet (for example, for a class C subnet, IP address: 192.168.20.0 and Netmask: 255.255.255.0).
- A single IP address (for example, IP Address: 192.168.20.1 and Netmask: 255.255.255.255)
- All possible IP addresses (represented by IP Address: 0.0.0.0 and Netmask: 0.0.0.0)



Note: IP address: 0.0.0.0 and Netmask: 255.255.255.255 is not a valid firewall address.

This section describes:

- [Adding addresses](#)
- [Editing addresses](#)
- [Deleting addresses](#)
- [Organizing addresses into address groups](#)

Adding addresses

To add an address

- 1 Go to **Firewall > Address**.
- 2 Select the interface, VLAN subinterface, or zone that you want to add the address to.
- 3 Select New to add a new address.
- 4 Enter an Address Name to identify the address.
The name can contain numbers (0-9), uppercase and lowercase letters (A-Z, a-z), and the special characters - and _. Spaces and other special characters are not allowed.
- 5 Enter the IP Address.
The IP address can be:
 - The IP address of a single computer (for example, 192.45.46.45).
 - The IP address of a subnetwork (for example, 192.168.1.0 for a class C subnet).
 - 0.0.0.0 to represent all possible IP addresses

6 Enter the Netmask.

The netmask corresponds to the type of address that you are adding. For example:

- The netmask for the IP address of a single computer should be 255.255.255.255.
- The netmask for a class A subnet should be 255.0.0.0.
- The netmask for a class B subnet should be 255.255.0.0.
- The netmask for a class C subnet should be 255.255.255.0.
- The netmask for all addresses should be 0.0.0.0



Note: To add an address to represent any address on a network set the IP Address to 0.0.0.0 and the Netmask to 0.0.0.0

7 Select OK to add the address.

Figure 55: Adding an internal address

New Address	
Interface	internal
Address Name	Internal_Server
IP Address	192.63.16.45
Netmask	255.255.255.255
OK Cancel	

Editing addresses

Edit an address to change its IP address and netmask. You cannot edit the address name. To change the address name, you must delete the address entry and then add the address again with a new name.



To edit an address

- 1 Go to **Firewall > Address**.
- 2 Select the interface list containing the address that you want to edit.
- 3 Choose an address to edit and select Edit Address
- 4 Make the required changes and select OK to save the changes.

Deleting addresses

Deleting an address removes it from an address list. To delete an address that has been added to a policy, you must first remove the address from the policy.

To delete an address

- 1 Go to **Firewall > Address**.
- 2 Select the interface list containing the address that you want to delete. You can delete any address that has a Delete Address icon .
- 3 Choose an address to delete and select Delete .
- 4 Select OK to delete the address.

Organizing addresses into address groups

You can organize related addresses into address groups to make it easier to add policies. For example, if you add three addresses and then add them to an address group, you only have to add one policy using the address group rather than a separate policy for each address.

You can add address groups to any interface, VLAN subinterface, or zone. The address group can only contain addresses from that interface, VLAN subinterface, or zone. Address groups are available in interface, VLAN subinterface, or zone source or destination address lists.

Address groups cannot have the same names as individual addresses. If an address group is included in a policy, it cannot be deleted unless it is first removed from the policy.

To organize addresses into an address group

- 1 Go to **Firewall > Address > Group**.
- 2 Select the interface, VLAN subinterface, or zone that you want to add the address group to.
- 3 Enter a Group Name to identify the address group.
The name can contain numbers (0-9), uppercase and lowercase letters (A-Z, a-z), and the special characters - and _. Other special characters and spaces are not allowed.
- 4 To add addresses to the address group, select an address from the Available Addresses list and select the right arrow to add it to the Members list.
- 5 To remove addresses from the address group, select an address from the Members list and select the left arrow to remove it from the group.
- 6 Select OK to add the address group.

Figure 56: Adding an internal address group

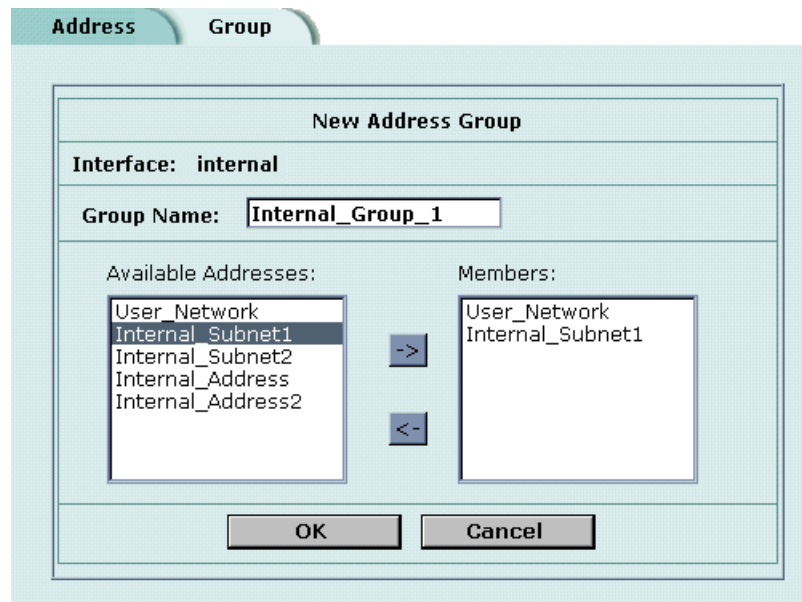

Services

Use services to determine the types of communication accepted or denied by the firewall. You can add any of the predefined services to a policy. You can also create custom services and add services to service groups.

This section describes:

- [Predefined services](#)
- [Adding custom TCP and UDP services](#)
- [Adding custom ICMP services](#)
- [Adding custom IP services](#)
- [Grouping services](#)

Predefined services

The FortiGate predefined firewall services are listed in [Table 46](#). You can add these services to any policy.

Table 46: FortiGate predefined services

Service name	Description	Protocol	Port
ANY	Match connections on any port. A connection that uses any of the predefined services is allowed through the firewall.	all	all

Table 46: FortiGate predefined services (Continued)

Service name	Description	Protocol	Port
GRE	Generic Routing Encapsulation. A protocol that allows an arbitrary network protocol to be transmitted over any other arbitrary network protocol, by encapsulating the packets of the protocol within GRE packets.		47
AH	Authentication Header. AH provides source host authentication and data integrity, but not secrecy. This protocol is used for authentication by IPSec remote gateways set to aggressive mode.		51
ESP	Encapsulating Security Payload. This service is used by manual key and AutoIKE VPN tunnels for communicating encrypted data. AutoIKE key VPN tunnels use ESP after establishing the tunnel using IKE.		50
AOL	AOL instant messenger protocol.	tcp	5190-5194
BGP	Border Gateway Protocol routing protocol. BGP is an interior/exterior routing protocol.	tcp	179
DHCP-Relay	Dynamic Host Configuration Protocol (DHCP) allocates network addresses and delivers configuration parameters from DHCP servers to hosts.	udp	67
DNS	Domain name service for translating domain names into IP addresses.	tcp	53
		udp	53
FINGER	A network service that provides information about users.	tcp	79
FTP	FTP service for transferring files.	tcp	21
GOPHER	Gopher communication service. Gopher organizes and displays Internet server contents as a hierarchically structured list of files.	tcp	70
H323	H.323 multimedia protocol. H.323 is a standard approved by the International Telecommunication Union (ITU) that defines how audiovisual conferencing data is transmitted across networks.	tcp	1720, 1503
HTTP	HTTP is the protocol used by the word wide web for transferring data for web pages.	tcp	80
HTTPS	HTTP with secure socket layer (SSL) service for secure communication with web servers.	tcp	443
IKE	IKE is the protocol to obtain authenticated keying material for use with ISAKMP for IPSEC.	udp	500
IMAP	Internet Message Access Protocol is a protocol used for retrieving email messages.	tcp	143
Internet-Locator-Service	Internet Locator Service includes LDAP, User Locator Service, and LDAP over TLS/SSL.	tcp	389
IRC	Internet Relay Chat allows people connected to the Internet to join live discussions.	tcp	6660-6669
L2TP	L2TP is a PPP-based tunnel protocol for remote access.	tcp	1701

Table 46: FortiGate predefined services (Continued)

Service name	Description	Protocol	Port
LDAP	Lightweight Directory Access Protocol is a set of protocols used to access information directories.	tcp	389
NetMeeting	NetMeeting allows users to teleconference using the Internet as the transmission medium.	tcp	1720
NFS	Network File System allows network users to access shared files stored on computers of different types.	tcp	111, 2049
NNTP	Network News Transport Protocol is a protocol used to post, distribute, and retrieve USENET messages.	tcp	119
NTP	Network time protocol for synchronizing a computer's time with a time server.	tcp	123
OSPF	Open Shortest Path First (OSPF) routing protocol. OSPF is a common link state routing protocol.		89
PC-Anywhere	PC-Anywhere is a remote control and file transfer protocol.	udp	5632
PING	ICMP echo request/reply for testing connections to other devices.	icmp	8
TIMESTAMP	ICMP timestamp request messages.	icmp	13
INFO_REQUEST	ICMP information request messages.	icmp	15
INFO_ADDRESS	ICMP address mask request messages.	icmp	17
POP3	Post office protocol email protocol for downloading email from a POP3 server.	tcp	110
PPTP	Point-to-Point Tunneling Protocol is a protocol that allows corporations to extend their own corporate network through private tunnels over the public Internet.	tcp	1723
QUAKE	For connections used by the popular Quake multi-player computer game.	udp	26000, 27000, 27910, 27960
RAUDIO	For streaming real audio multimedia traffic.	udp	7070
RLOGIN	Rlogin service for remotely logging into a server.	tcp	513
RIP	Routing Information Protocol is a common distance vector routing protocol.	udp	520
SMTP	For sending mail between email servers on the Internet.	tcp	25
SNMP	Simple Network Management Protocol is a set of protocols for managing complex networks	tcp	161-162
		udp	161-162
SSH	SSH service for secure connections to computers for remote management.	tcp	22
		udp	22
SYSLOG	Syslog service for remote logging.	udp	514
TALK	A protocol supporting conversations between two or more users.	udp	517-518

Table 46: FortiGate predefined services (Continued)

Service name	Description	Protocol	Port
TCP	All TCP ports.	tcp	0-65535
TELNET	Telnet service for connecting to a remote computer to run commands.	tcp	23
TFTP	Trivial file transfer protocol, a simple file transfer protocol similar to FTP but with no security features.	udp	69
UDP	All UDP ports.	udp	0-65535
UUCP	Unix to Unix copy utility, a simple file copying protocol.	udp	540
VDOLIVE	For VDO Live streaming multimedia traffic.	tcp	7000-7010
WAIS	Wide Area Information Server. An Internet search protocol.	tcp	210
WINFRAME	For WinFrame communications between computers running Windows NT.	tcp	1494
X-WINDOWS	For remote communications between an X-Window server and X-Window clients.	tcp	6000-6063

Adding custom TCP and UDP services

Add a custom TCP or UDP service if you need to create a policy for a service that is not in the predefined service list.

To add a custom TCP or UDP service

- 1 Go to **Firewall > Service > Custom**.
- 2 Select TCP/UDP from the Protocol list.
- 3 Select New.
- 4 Type a Name for the new custom TCP or UDP service. This name appears in the service list used when you add a policy.
The name can contain numbers (0-9), uppercase and lowercase letters (A-Z, a-z), and the special characters - and _. Other special characters and spaces are not allowed.
- 5 Select the Protocol (either TCP or UDP) used by the service.
- 6 Specify a Source and Destination Port number range for the service by entering the low and high port numbers. If the service uses one port number, enter this number in both the low and high fields.
- 7 If the service has more than one port range, select Add to specify additional protocols and port ranges.
If there are too many port range rows, select Delete  to remove each extra row.
- 8 Select OK to add the custom service.
You can now add this custom service to a policy.

Adding custom ICMP services

Add a custom ICMP service if you need to create a policy for a service that is not in the predefined service list.

To add a custom ICMP service

- 1 Go to **Firewall > Service > Custom**.
- 2 Select ICMP from the Protocol list.
- 3 Select New.
- 4 Type a Name for the new custom ICMP service. This name appears in the service list used when you add a policy.
The name can contain numbers (0-9), uppercase and lowercase letters (A-Z, a-z), and the special characters - and _. Other special characters and spaces are not allowed.
- 5 Specify the ICMP type and code for the service.
- 6 Select OK to add the custom service.
You can now add this custom service to a policy.

Adding custom IP services

Add a custom IP service if you need to create a policy for a service that is not in the predefined service list.

To add a custom IP service

- 1 Go to **Firewall > Service > Custom**.
- 2 Select IP from the Protocol list.
- 3 Select New.
- 4 Type a Name for the new custom IP service. This name appears in the service list used when you add a policy.
The name can contain numbers (0-9), uppercase and lowercase letters (A-Z, a-z), and the special characters - and _. Other special characters and spaces are not allowed.
- 5 Specify the IP protocol number for the service.
- 6 Select OK to add the custom service.
You can now add this custom service to a policy.

Grouping services

To make it easier to add policies, you can create groups of services and then add one policy to provide or block access for all the services in the group. A service group can contain predefined services and custom services in any combination. You cannot add service groups to another service group.

To group services

- 1 Go to **Firewall > Service > Group**.
- 2 Select New.

- 3 Type a Group Name to identify the group.
This name appears in the service list when you add a policy and cannot be the same as a predefined service name.
The name can contain numbers (0-9), uppercase and lowercase letters (A-Z, a-z), and the special characters - and _. Other special characters and spaces are not allowed.
- 4 To add services to the service group, select a service from the Available Services list and select the right arrow to copy it to the Members list.
- 5 To remove services from the service group, select a service from the Members list and select the left arrow to remove it from the group.
- 6 Select OK to add the service group.

Figure 57: Adding a service group

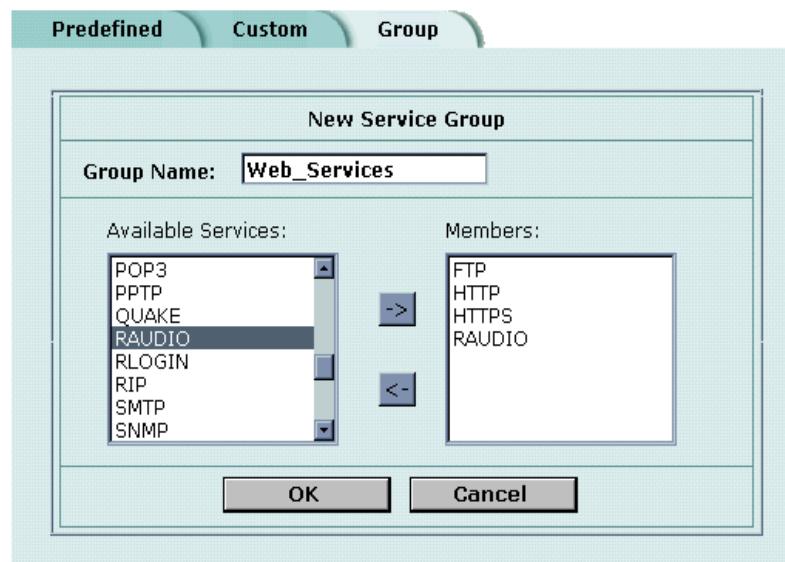

Schedules

Use schedules to control when policies are active or inactive. You can create one-time schedules and recurring schedules.

You can use one-time schedules to create policies that are effective once for the period of time specified in the schedule. Recurring schedules repeat weekly. You can use recurring schedules to create policies that are effective only at specified times of the day or on specified days of the week.

This section describes:

- [Creating one-time schedules](#)
- [Creating recurring schedules](#)
- [Adding schedules to policies](#)

Creating one-time schedules

You can create a one-time schedule that activates or deactivates a policy for a specified period of time. For example, your firewall might be configured with the default policy that allows access to all services on the Internet at all times. You can add a one-time schedule to block access to the Internet during a holiday period.

To create a one-time schedule

- 1 Go to **Firewall > Schedule > One-time**.
- 2 Select New.
- 3 Type a Name for the schedule.
The name can contain numbers (0-9), uppercase and lowercase letters (A-Z, a-z), and the special characters - and _. Other special characters and spaces are not allowed.
- 4 Set the Start date and time for the schedule.
Set Start and Stop times to 00 for the schedule to be active for the entire day.
- 5 Set the Stop date and time for the schedule.
One-time schedules use a 24-hour clock.
- 6 Select OK to add the one-time schedule.

Figure 58: Adding a one-time schedule

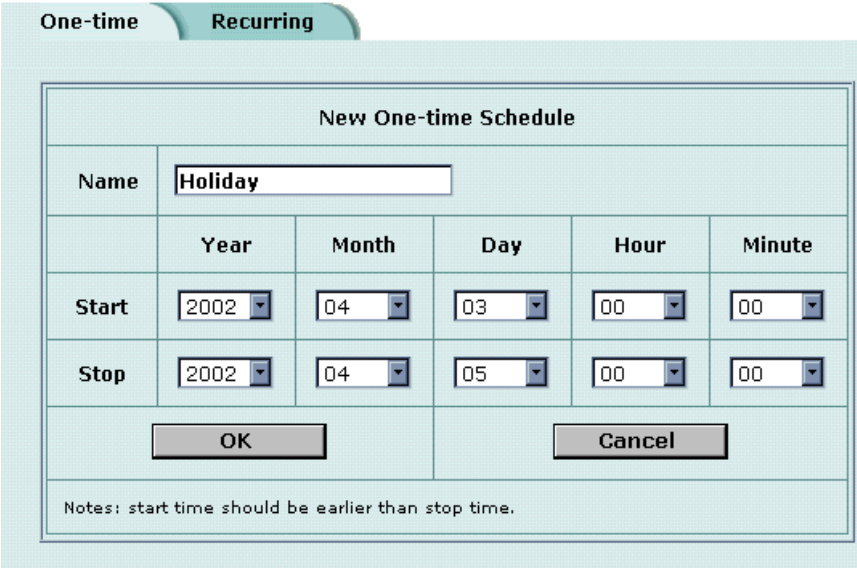

New One-time Schedule					
Name	Holiday				
	Year	Month	Day	Hour	Minute
Start	2002	04	03	00	00
Stop	2002	04	05	00	00
OK			Cancel		
Notes: start time should be earlier than stop time.					

Creating recurring schedules

You can create a recurring schedule that activates or deactivates policies at specified times of the day or on specified days of the week. For example, you might want to prevent Internet use outside working hours by creating a recurring schedule.

If you create a recurring schedule with a stop time that occurs before the start time, the schedule starts at the start time and finishes at the stop time on the next day. You can use this technique to create recurring schedules that run from one day to the next. You can also create a recurring schedule that runs for 24 hours by setting the start and stop times to the same time.

To create a recurring schedule

- 1 Go to **Firewall > Schedule > Recurring**.
- 2 Select New to create a new schedule.
- 3 Type a Name for the schedule.
The name can contain numbers (0-9), uppercase and lowercase letters (A-Z, a-z), and the special characters - and _. Other special characters and spaces are not allowed.
- 4 Select the days of the week that you want the schedule to be active on.
- 5 Set the Start and Stop hours in between which you want the schedule to be active.
Recurring schedules use a 24-hour clock.
- 6 Select OK to save the recurring schedule.

Figure 59: Adding a recurring schedule

One-time
Recurring

New Recurring Schedule

Name	<input style="width: 95%;" type="text" value="Working_Week"/>						
Day	Sun	Mon	Tue	Wed	Thu	Fri	Sat
Select	<input type="checkbox"/>	<input checked="" type="checkbox"/>	<input checked="" type="checkbox"/>	<input checked="" type="checkbox"/>	<input checked="" type="checkbox"/>	<input checked="" type="checkbox"/>	<input type="checkbox"/>
Start	Hour		08	Minute		00	
Stop	Hour		17	Minute		00	
<input type="button" value="OK"/>				<input type="button" value="Cancel"/>			

Notes: If the stop time is set earlier than the start time, the stop time will be during next day. If the start time is equal to the stop time, the schedule will run for 24 hours.

Adding schedules to policies

After you create schedules, you can add them to policies to schedule when the policies are active. You can add the new schedules to policies when you create the policy, or you can edit existing policies and add a new schedule to them.

To add a schedule to a policy

- 1 Go to **Firewall > Policy**.
- 2 Create a new policy or edit a policy to change its schedule.
- 3 Configure the policy as required.
- 4 Add a schedule by selecting it from the Schedule list.
- 5 Select OK to save the policy.
- 6 Arrange the policy in the policy list to have the effect that you expect.

For example, to use a one-time schedule to deny access to a policy, add a policy that matches the policy to be denied in every way. Choose the one-time schedule that you added and set Action to DENY. Then place the policy containing the one-time schedule in the policy list above the policy to be denied.

Virtual IPs

Use virtual IPs to access IP addresses on a destination network that are hidden from the source network by NAT security policies. To allow connections between these networks, you must create a mapping between an address on the source network and the real address on the destination network. This mapping is called a virtual IP.

For example, if the computer hosting your web server is located on your internal network, it might have a private IP address such as 192.168.1.34. To get packets from the Internet to the web server, you must have an external address for the web server on the Internet. You must then add a virtual IP to the firewall that maps the external IP address of the web server to the actual address of the web server on the internal network. To allow connections from the Internet to the web server, you must then add an External->Internal firewall policy and set Destination to the virtual IP.

You can create two types of virtual IPs:

Static NAT Used to translate an address on a source network to a hidden address on a destination network. Static NAT translates the source address of return packets to the address on the source network.

Port Forwarding Used to translate an address and a port number on a source network to a hidden address and, optionally, a different port number on a destination network. Using port forwarding you can also route packets with a specific port number and a destination address that matches the IP address of the interface that receives the packets. This technique is called port forwarding or port address translation (PAT). You can also use port forwarding to change the destination port of the forwarded packets.

This section describes:

- [Adding static NAT virtual IPs](#)
- [Adding port forwarding virtual IPs](#)
- [Adding policies with virtual IPs](#)

Adding static NAT virtual IPs

To add a static NAT virtual IP

- 1 Go to **Firewall > Virtual IP**.
- 2 Select **New** to add a virtual IP.
- 3 Type a Name for the virtual IP.
The name can contain numbers (0-9), uppercase and lowercase letters (A-Z, a-z), and the special characters - and _. Other special characters and spaces are not allowed.
- 4 Select the virtual IP External Interface from the list.
The external interface is the interface connected to the source network that receives the packets to be forwarded to the destination network.
You can select any firewall interface or a VLAN subinterface.
You can set the virtual IP external interface to any FortiGate interface. [Table 47](#) contains example virtual IP external interface settings and describes the policies that you can add the resulting virtual IP to.

Table 47: Virtual IP External Interface examples

External Interface	Description
internal	To map an internal address to an address on a network connected to another interface, VLAN subinterface, or zone. If you select internal, the static NAT virtual IP can be added to policies for connections from the internal interface or any zone containing the internal interface, to any other interface, VLAN subinterface, or zone.
external	To map an external address to an address on a network connected to another interface, VLAN subinterface, or zone. If you select external, the static NAT virtual IP can be added to policies for connections from the external interface or any zone containing the external interface, to any other interface, VLAN subinterface, or zone.

- 5 In the **Type** section, select **Static NAT**.
- 6 Enter the **External IP Address** that you want to map to an address on the destination network.
For example, if the virtual IP provides access from the Internet to a web server on a destination network, the external IP address must be a static IP address obtained from your ISP for your web server. This address must be a unique address that is not used by another host and cannot be the same as the IP address of the external interface selected in step 4. However, this address must be routed to this interface. The virtual IP address and the external IP address can be on different subnets.
If the IP address of the external interface selected in step 4 is set using PPPoE or DHCP, you can enter 0.0.0.0 for the external IP address. The FortiGate unit substitutes the IP address set for this external interface using PPPoE or DHCP.

- 7 In Map to IP, type the real IP address on the destination network, for example, the IP address of a web server on an internal network.



Note: The firewall translates the source address of outbound packets from the host with the Map to IP address to the virtual IP External IP Address, instead of the firewall external address.

- 8 Select OK to save the virtual IP.
You can now add the virtual IP to firewall policies.

Figure 60: Adding a static NAT virtual IP

The screenshot shows a dialog box titled "Virtual IP" with a sub-header "Add New Virtual IP Mapping". The fields are as follows:

- Name:** Web_Server
- External Interface:** external
- Type:** Static NAT (selected), Port Forwarding
- External IP Address:** 173.87.39.21
- Map to IP:** 10.10.10.5

Buttons for "OK" and "Cancel" are located at the bottom of the dialog.

Adding port forwarding virtual IPs

To add port forwarding virtual IPs

- 1 Go to **Firewall > Virtual IP**.
- 2 Select New to add a virtual IP.
- 3 Type a Name for the virtual IP.
The name can contain numbers (0-9), uppercase and lowercase letters (A-Z, a-z), and the special characters - and _. Other special characters and spaces are not allowed.
- 4 Select the virtual IP External Interface from the list.
The external interface is the interface connected to the source network that receives the packets to be forwarded to the destination network.
You can select any firewall interface or a VLAN subinterface.
- 5 In the Type section, select Port Forwarding.

- 6** Enter the External IP Address that you want to map to an address on the destination zone.

You can set the external IP address to the IP address of the external interface selected in step 4 or to any other address.

If the IP address of the external interface selected in step 4 is set using PPPoE or DHCP, you can enter 0.0.0.0 for the External IP Address. The FortiGate unit substitutes the IP address set for this external interface using PPPoE or DHCP.

For example, if the virtual IP provides access from the Internet to a server on your internal network, the external IP address must be a static IP address obtained from your ISP for this server. This address must be a unique address that is not used by another host. However, this address must be routed to the external interface selected in step 4. The virtual IP address and the external IP address can be on different subnets.
- 7** Enter the External Service Port number that you want to configure port forwarding for. The external service port number must match the destination port of the packets to be forwarded. For example, if the virtual IP provides access from the Internet to a web server, the external service port number is 80 (the HTTP port).
- 8** In Map to IP, enter the real IP address on the destination network.

For example, the real IP address could be the IP address of a web server on an internal network.
- 9** In Map to Port, enter the port number to be added to packets when they are forwarded.

Figure 61: Adding a port forwarding virtual IP

The screenshot shows a configuration window for adding a new virtual IP mapping. The window is titled "Virtual IP" and "Add New Virtual IP Mapping". It contains the following fields and options:

- Name:** Web_Server
- External Interface:** external
- Type:** Static NAT Port Forwarding
- External IP Address:** 173.87.39.21
- External Service Port:** 80
- Map to IP:** 10.10.10.5
- Map to Port:** 80
- Protocol:** TCP UDP

At the bottom of the window are two buttons: "OK" and "Cancel".

Adding policies with virtual IPs

Use the following procedure to add a policy that uses a virtual IP to forward packets.

To add a policy with a virtual IP

- 1 Go to **Firewall > Policy**.
- 2 Select the type of policy that you want to add.
 - The source interface must match the interface selected in the External Interface list.
 - The destination interface must match the interface connected to the network with the Map to IP address.
- 3 Use the following information to configure the policy.

Source	Select the source address from which users can access the server.
Destination	Select the virtual IP.
Schedule	Select a schedule as required.
Service	Select the service that matches the Map to Service that you selected for the port-forwarding virtual IP.
Action	Set action to ACCEPT to accept connections to the internal server. You can also select DENY to deny access.
NAT	Select NAT if the firewall is protecting the private addresses on the destination network from the source network.

- 4 Select OK to save the policy.

IP pools

An IP pool (also called a dynamic IP pool) is a range of IP addresses added to a firewall interface. If you add IP pools to an interface, you can select Dynamic IP Pool when you configure a policy with the destination set to this interface. You can add an IP pool if you want to add NAT mode policies that translate source addresses to addresses randomly selected from the IP pool rather than being limited to the IP address of the destination interface.

If you add an IP pool to the internal interface, you can select Dynamic IP pool for policies with the internal interface as the destination. For example, you can add IP pools to External->Internal policies.

You can add multiple IP pools to any interface but only the first IP pool is used by the firewall.

and Cisco:

IP Pool Dynamic IP Pool
IP Pool Dynamic IP Pool

Figure 62: Adding an IP Pool

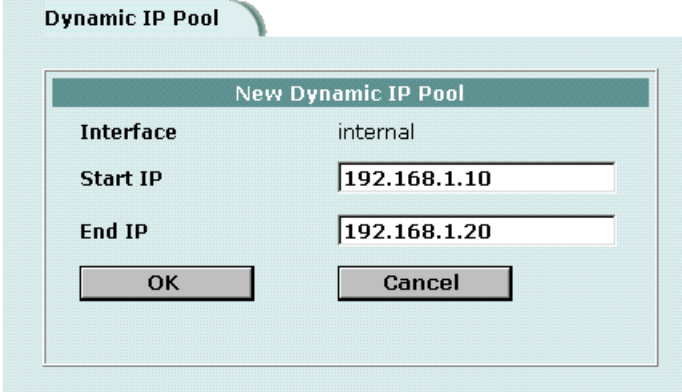

The screenshot shows a configuration window titled "Dynamic IP Pool" with a sub-dialog "New Dynamic IP Pool". The sub-dialog has three input fields: "Interface" with the value "internal", "Start IP" with the value "192.168.1.10", and "End IP" with the value "192.168.1.20". At the bottom of the sub-dialog are two buttons: "OK" and "Cancel".

IP Pools for firewall policies that use fixed ports

Some network configurations do not operate correctly if a NAT policy translates the source port of packets used by the connection. NAT translates source ports to keep track of connections for a particular service. You can select fixed port for NAT policies to prevent source port translation. However, selecting fixed port means that only one connection can be supported through the firewall for this service. To be able to support multiple connections, you can add an IP pool to the destination interface, and then select dynamic IP pool in the policy. The firewall randomly selects an IP address from the IP pool and assigns it to each connection. In this case the number of connections that the firewall can support is limited by the number of IP addresses in the IP pool.

IP pools and dynamic NAT

You can use IP pools for dynamic NAT. For example, your organization might have purchased a range of Internet addresses but you might have only one Internet connection on the external interface of your FortiGate unit.

You can assign one of your organization's Internet IP addresses to the external interface of the FortiGate unit. If the FortiGate unit is operating in NAT/Route mode, all connections from your network to the Internet appear to come from this IP address.

If you want connections to originate from all your Internet IP addresses, you can add this address range to an IP pool for the external interface. Then you can select Dynamic IP Pool for all policies with the external interface as the destination. For each connection, the firewall dynamically selects an IP address from the IP pool to be the source address for the connection. As a result, connections to the Internet appear to be originating from any of the IP addresses in the IP pool.

IP/MAC binding

IP/MAC binding protects the FortiGate unit and your network from IP spoofing attacks. IP spoofing attacks try to use the IP address of a trusted computer to connect to, or through, the FortiGate unit from a different computer. The IP address of a computer is easy to change to a trusted address, but MAC addresses are added to ethernet cards at the factory and are not easy to change.

You can enter the static IP addresses and corresponding MAC addresses of trusted computers in the static IP/MAC table.

If you have trusted computers with dynamic IP addresses that are set by the FortiGate DHCP server, the FortiGate unit adds these IP addresses and their corresponding MAC addresses to the dynamic IP/MAC table. For information about viewing the table, see [“Viewing a DHCP server dynamic IP list” on page 165](#). The dynamic IP/MAC binding table is not available in Transparent mode.

You can enable IP/MAC binding for packets in sessions connecting to the firewall or passing through the firewall.



Note: If you enable IP/MAC binding and change the IP address of a computer with an IP or MAC address in the IP/MAC list, you must also change the entry in the IP/MAC list or the computer does not have access to or through the FortiGate unit. You must also add the IP/MAC address pair of any new computer that you add to your network or the new computer does not have access to or through the FortiGate unit.

This section describes:

- [Configuring IP/MAC binding for packets going through the firewall](#)
- [Configuring IP/MAC binding for packets going to the firewall](#)
- [Adding IP/MAC addresses](#)
- [Viewing the dynamic IP/MAC list](#)
- [Enabling IP/MAC binding](#)

Configuring IP/MAC binding for packets going through the firewall

Use the following procedure to use IP/MAC binding to filter packets that a firewall policy would normally allow through the firewall.

To configure IP/MAC binding for packets going through the firewall

- 1 Go to **Firewall > IP/MAC Binding > Setting**.
- 2 Select the Enable IP/MAC binding going through the firewall check box.
- 3 Go to **Firewall > IP/MAC Binding > Static IP/MAC**.
- 4 Select New to add IP/MAC binding pairs to the IP/MAC binding list.

All packets that would normally be allowed through the firewall by a firewall policy are first compared with the entries in the IP/MAC binding list. If a match is found, then the firewall attempts to match the packet with a policy.

For example, if the IP/MAC pair IP 1.1.1.1 and 12:34:56:78:90:ab:cd is added to the IP/MAC binding list:

- A packet with IP address 1.1.1.1 and MAC address 12:34:56:78:90:ab:cd is allowed to go on to be matched with a firewall policy.
- A packet with IP 1.1.1.1 but with a different MAC address is dropped immediately to prevent IP spoofing.
- A packet with a different IP address but with a MAC address of 12:34:56:78:90:ab:cd is dropped immediately to prevent IP spoofing.
- A packet with both the IP address and MAC address not defined in the IP/MAC binding table:
 - is allowed to go on to be matched with a firewall policy if IP/MAC binding is set to Allow traffic,
 - is blocked if IP/MAC binding is set to Block traffic.

Configuring IP/MAC binding for packets going to the firewall

Use the following procedure to use IP/MAC binding to filter packets that would normally connect with the firewall (for example, when an administrator is connecting to the FortiGate unit for management).

To configure IP/MAC binding for packets going to the firewall

- 1 Go to **Firewall > IP/MAC Binding > Setting**.
- 2 Select the Enable IP/MAC binding going to the firewall check box.
- 3 Go to **Firewall > IP/MAC Binding > Static IP/MAC**.
- 4 Select New to add IP/MAC binding pairs to the IP/MAC binding list.

All packets that would normally connect to the firewall are first compared with the entries in the IP/MAC binding table.

For example, if the IP/MAC pair IP 1.1.1.1 and 12:34:56:78:90:ab:cd is added to the IP/MAC binding list:

- A packet with IP address 1.1.1.1 and MAC address 12:34:56:78:90:ab:cd is allowed to connect to the firewall.
- A packet with IP 1.1.1.1 but with a different MAC address is dropped immediately to prevent IP spoofing.
- A packet with a different IP address but with a MAC address of 12:34:56:78:90:ab:cd is dropped immediately to prevent IP spoofing.
- A packet with both the IP address and MAC address not defined in the IP/MAC binding table:
 - is allowed to connect to the firewall if IP/MAC binding is set to Allow traffic,
 - is blocked if IP/MAC binding is set to Block traffic.

Adding IP/MAC addresses

To add an IP/MAC address

- 1 Go to **Firewall > IP/MAC Binding > Static IP/MAC**.
- 2 Select New to add an IP address/MAC address pair.

- 3 Enter the IP Address and the MAC Address.
You can bind multiple IP addresses to the same MAC address. You cannot bind multiple MAC addresses to the same IP address.
However, you can set the IP address to 0.0.0.0 for multiple MAC addresses. This means that all packets with these MAC addresses are matched with the IP/MAC binding list.
Similarly, you can set the MAC address to 00:00:00:00:00:00 for multiple IP addresses. This means that all packets with these IP addresses are matched with the IP/MAC binding list.
- 4 Type a Name for the new IP/MAC address pair.
The name can contain numbers (0-9), uppercase and lowercase letters (A-Z, a-z), and the special characters - and _. Other special characters and spaces are not allowed.
- 5 Select the Enable check box to enable IP/MAC binding for the IP/MAC pair.
- 6 Select OK to save the IP/MAC binding pair.

Viewing the dynamic IP/MAC list

To view the dynamic IP/MAC list

- 1 Go to **Firewall > IP/MAC Binding > Dynamic IP/MAC**.

Enabling IP/MAC binding



Caution: Make sure that you have added the IP/MAC Address pair of your management computer before enabling IP/MAC binding.

To enable IP/MAC binding

- 1 Go to **Firewall > IP/MAC Binding > Setting**.
- 2 Select the Enable IP/MAC binding going through the firewall check box if you want to turn on IP/MAC binding for packets that could be matched by policies.
- 3 Select the Enable IP/MAC binding going to the firewall check box if you want to turn on IP/MAC binding for packets connecting to the firewall.
- 4 Configure how IP/MAC binding handles packets with IP and MAC addresses that are not defined in the IP/MAC list.
Select Allow traffic to allow all packets with IP and MAC address pairs that are not added to the IP/MAC binding list.
Select Block traffic to block packets with IP and MAC address pairs that are not added to the IP/MAC binding list.
- 5 Select Apply to save the changes.

Figure 63: IP/MAC settings

Setting Static IP/MAC Dynamic IP/MAC

Enable IP/MAC binding going through the firewall.

Enable IP/MAC binding going to the firewall.

For hosts not defined in table:

Allow traffic.

Block traffic.

Apply

Content profiles

Use content profiles to apply different protection settings for content traffic that is controlled by firewall policies. You can use content profiles to:

- Configure antivirus protection for HTTP, FTP, POP3, SMTP, and IMAP policies
- Configure web filtering for HTTP policies
- Configure email filtering for IMAP and POP3 policies
- Configure oversized file and email blocking for HTTP, FTP, POP3, SMTP, and IMAP policies
- Pass fragmented email for POP3, SMTP, and IMAP policies

Using content profiles, you can build protection configurations that can be applied to different types of firewall policies. This allows you to customize types and levels of protection for different firewall policies.

For example, while traffic between internal and external addresses might need strict protection, traffic between trusted internal addresses might need moderate protection. You can configure policies for different traffic services to use the same or different content profiles.

Content profiles can be added to NAT/Route mode and Transparent mode policies.

- [Default content profiles](#)
- [Adding content profiles](#)
- [Adding content profiles to policies](#)

Default content profiles

The FortiGate unit has the following four default content profiles that are displayed on the Firewall Content Profile page. You can use the default content profiles or create your own.

Strict	To apply maximum content protection to HTTP, FTP, IMAP, POP3, and SMTP content traffic. You would not use the strict content profile under normal circumstances but it is available if you have extreme problems with viruses and require maximum content screening protection.
Scan	To apply antivirus scanning to HTTP, FTP, IMAP, POP3, and SMTP content traffic.
Web	To apply antivirus scanning and web content blocking to HTTP content traffic. You can add this content profile to firewall policies that control HTTP traffic.
Unfiltered	Use if you do not want to apply content protection to content traffic. You can add this content profile to firewall policies for connections between highly trusted or highly secure networks where content does not need to be protected.

Adding content profiles

If the default content profiles do not provide the protection that you require, you can create custom content profiles.

To add a content profile

- 1 Go to **Firewall > Content Profile**.
- 2 Select **New**.
- 3 Type a Profile Name.
- 4 Enable the antivirus protection options that you want.

Anti Virus Scan	Scan web, FTP, and email traffic for viruses and worms. See “Antivirus scanning” on page 282 .
File Block	Delete files with blocked file patterns even if they do not contain viruses. Enable file blocking when a virus has been found that is so new that virus scanning does not detect it. See “File blocking” on page 283 .



Note: If both Anti Virus Scan and File Block are enabled, the FortiGate unit blocks files that match enabled file patterns before they are scanned for viruses.

- 5 Enable the web filtering options that you want.

Web URL Block	Block unwanted web pages and web sites. This option adds FortiGate Web URL blocking (see “Configuring FortiGate Web URL blocking” on page 291), FortiGate Web Pattern blocking (see “Configuring FortiGate Web pattern blocking” on page 294), and Cerberian URL filtering (see “Configuring Cerberian URL filtering” on page 294) to HTTP traffic accepted by a policy.
Web Content Block	Block web pages that contain unwanted words or phrases. See “Content blocking” on page 288 .
Web Script Filter	Remove scripts from web pages. See “Script filtering” on page 297 .

-
- Web Exempt List** Exempt URLs from web filtering and virus scanning. See [“Exempt URL list” on page 298](#).
- 6** Enable the email filter protection options that you want.
- Email Block List** Add a subject tag to email from unwanted addresses. See [“Email block list” on page 304](#).
- Email Exempt List** Exempt sender address patterns from email filtering. See [“Email exempt list” on page 305](#).
- Email Content Block** Add a subject tag to email that contains unwanted words or phrases. See [“Email banned word list” on p0000 5](#)
- 7** Enable the fragmented email and oversized file and email options that you want.
- [“nfi](#)

- 8** Select OK.

Figure 64: Example content profile

Adding content profiles to policies

You can add content profiles to policies with action set to allow or encrypt and with service set to ANY, HTTP, FTP, IMAP, POP3, SMTP, or a service group that includes these services.

To add a content profile to a policy

- 1 Go to **Firewall > Policy**.
- 2 Select a policy list that contains policies that you want to add a content profile to. For example, to enable network protection for files downloaded by internal network users from the web, select an internal to external policy list.
- 3 Select New to add a new policy, or choose a policy and select Edit .
- 4 Select the Anti-Virus & Web filter check box.
- 5 Select a content profile from the list.
- 6 Configure the remaining policy settings, if required.
- 7 Select OK.
- 8 Repeat this procedure for any policies that you want to enable network protection for.

Users and authentication

FortiGate units support user authentication to the FortiGate user database, a RADIUS server, and an LDAP server. You can add user names to the FortiGate user database and then add a password to allow the user to authenticate using the internal database. You can also add the names of RADIUS and LDAP servers. You can select RADIUS to allow the user to authenticate using the selected RADIUS server or LDAP to allow the user to authenticate using the selected LDAP server. You can disable a user name so that the user cannot authenticate.

To enable authentication, you must add user names to one or more user groups. You can also add RADIUS servers and LDAP servers to user groups. You can then select a user group when you require authentication.

You can select user groups to require authentication for:

- any firewall policy with Action set to ACCEPT
- IPSec dialup user phase 1 configurations
- XAuth functionality for phase 1 IPSec VPN configurations
- PPTP
- L2TP

When a user enters a user name and password, the FortiGate unit searches the internal user database for a matching user name. If Disable is selected for that user name, the user cannot authenticate and the connection is dropped. If Password is selected for that user and the password matches, the connection is allowed. If the password does not match, the connection is dropped.

If RADIUS is selected and RADIUS support is configured and the user name and password match a user name and password on the RADIUS server, the connection is allowed. If the user name and password do not match a user name and password on the RADIUS server, the connection is dropped.

If LDAP is selected and LDAP support is configured and the user name and password match a user name and password on the LDAP server, the connection is allowed. If the user name and password do not match a user name and password on the LDAP server, the connection is dropped.

If the user group contains user names, RADIUS servers, and LDAP servers, the FortiGate unit checks them in the order in which they have been added to the user group.

This chapter describes:

- [Setting authentication timeout](#)
- [Adding user names and configuring authentication](#)
- [Configuring RADIUS support](#)
- [Configuring LDAP support](#)
- [Configuring user groups](#)

Setting authentication timeout

Authentication timeout controls how long authenticated firewall connections can remain idle before users must authenticate again to get access through the firewall.

To set authentication timeout

- 1 Go to **System > Config > Options**.
- 2 In Auth Timeout, type a number, in minutes.
The default authentication timeout is 15 minutes.

Adding user names and configuring authentication

Use the following procedures to add user names and configure authentication.

This section describes:

- [Adding user names and configuring authentication](#)
- [Deleting user names from the internal database](#)

Adding user names and configuring authentication

To add a user name and configure authentication

- 1 Go to **User > Local**.
- 2 Select New to add a new user name.
- 3 Type the User Name.
The user name can contain numbers (0-9), uppercase and lowercase letters (A-Z, a-z), and the special characters - and _. Other special characters and spaces are not allowed.
- 4 Select one of the following authentication configurations:

Disable	Prevent this user from authenticating.
Password	Enter the password that this user must use to authenticate. The password should be at least six characters long. The password can contain numbers (0-9), uppercase and lowercase letters (A-Z, a-z), and the special characters - and _. Other special characters and spaces are not allowed.

- LDAP** Require the user to authenticate to an LDAP server. Select the name of the LDAP server to which the user must authenticate. You can only select an LDAP server that has been added to the FortiGate LDAP configuration. See ["Configuring LDAP support" on page 231](#).
- Radius** Require the user to authenticate to a RADIUS server. Select the name of the RADIUS server to which the user must authenticate. You can only select a RADIUS server that has been added to the FortiGate RADIUS configuration. See ["Configuring RADIUS support" on page 230](#).

- 5 Select the Try other servers if connect to selected server fails check box if you have selected Radius and you want the FortiGate unit to try to connect to other RADIUS servers added to the FortiGate RADIUS configuration.
- 6 Select OK.

Figure 65: Adding a user name

Deleting user names from the internal database

You cannot delete user names that have been added to user groups. Remove user names from user groups before deleting them.

To delete a user name from the internal database

- 1 Go to **User > Local**.
- 2 Select Delete User  for the user name that you want to delete.
- 3 Select OK.



Note: Deleting the user name deletes the authentication configured for the user.

Configuring RADIUS support

If you have configured RADIUS support and a user is required to authenticate using a RADIUS server, the FortiGate unit contacts the RADIUS server for authentication.

This section describes:

- [Adding RADIUS servers](#)
- [Deleting RADIUS servers](#)

Adding RADIUS servers

To add a RADIUS server

- 1 Go to **User > RADIUS**.
- 2 Select New to add a new RADIUS server.
- 3 Type the Name of the RADIUS server.
You can type any name. The name can contain numbers (0-9), uppercase and lowercase letters (A-Z, a-z), and the special characters - and _. Other special characters and spaces are not allowed.
- 4 Enter the Server Name or IP address of the RADIUS server.
- 5 Enter the RADIUS server secret.
- 6 Select OK.

Figure 66: Example RADIUS configuration

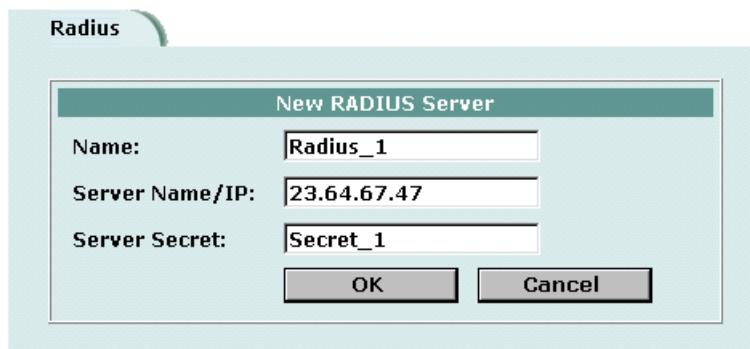

The screenshot shows a 'Radius' configuration window with a 'New RADIUS Server' dialog box. The dialog box contains the following fields and values:

Field	Value
Name:	Radius_1
Server Name/IP:	23.64.67.47
Server Secret:	Secret_1

Buttons: OK, Cancel

Deleting RADIUS servers

You cannot delete a RADIUS server that has been added to a user group.

To delete a RADIUS server

- 1 Go to **User > RADIUS**.
- 2 Select Delete  beside the RADIUS server name that you want to delete.
- 3 Select OK.

Configuring LDAP support

If you have configured LDAP support and a user is required to authenticate using an LDAP server, the FortiGate unit contacts the LDAP server for authentication. To authenticate with the FortiGate unit, the user enters a user name and password. The FortiGate unit sends this user name and password to the LDAP server. If the LDAP server can authenticate the user, the user is successfully authenticated with the FortiGate unit. If the LDAP server cannot authenticate the user, the connection is refused by the FortiGate unit.

The FortiGate unit supports LDAP protocol functionality defined in RFC2251 for looking up and validating user names and passwords. FortiGate LDAP supports all LDAP servers compliant with LDAP v3.

FortiGate LDAP support does not extend to proprietary functionality, such as notification of password expiration, that is available from some LDAP servers. FortiGate LDAP support does not supply information to the user about why authentication failed.

LDAP user authentication is supported for PPTP, L2TP, IPsec VPN, and firewall authentication. With PPTP, L2TP, and IPsec VPN, PAP (packet authentication protocol) is supported and CHAP (Challenge-Handshake Authentication Protocol) is not.

This section describes:

- [Adding LDAP servers](#)
- [Deleting LDAP servers](#)

Adding LDAP servers

To add an LDAP server

- 1 Go to **User > LDAP**.
- 2 Select New to add a new LDAP server.
- 3 Type the Name of the LDAP server.
You can type any name. The name can contain numbers (0-9), uppercase and lowercase letters (A-Z, a-z), and the special characters - and _. Other special characters and spaces are not allowed.
- 4 Enter the Server Name or IP address of the LDAP server.
- 5 Enter the Server Port used to communicate with the LDAP server.
By default LDAP uses port 389.
- 6 Enter the common name identifier for the LDAP server.
The common name identifier for most LDAP servers is cn. However some servers use other common name identifiers such as uid.

- 7 Enter the distinguished name used to look up entries on the LDAP server. Enter the base distinguished name for the server using the correct X.500 or LDAP format. The FortiGate unit passes this distinguished name unchanged to the server. For example, you could use the following base distinguished name:
`ou=marketing,dc=fortinet,dc=com`
 where ou is organization unit and dc is domain component
 You can also specify multiple instances of the same field in the distinguished name, for example, to specify multiple organization units:
`ou=accounts,ou=marketing,dc=fortinet,dc=com`
- 8 Select OK.

Figure 67: Example LDAP configuration

The screenshot shows a 'New LDAP Server' configuration window. The fields are as follows:

Field	Value
Name	LDAP_1
Server Name/IP	1.32.4.5
Server Port	389
Common Name Identifier	cn
Distinguished Name	ou=marketing,dc=fortinet,dc=com

Buttons: OK, Cancel

Deleting LDAP servers

You cannot delete an LDAP server that has been added to a user group.

To delete an LDAP server

- 1 Go to **User > LDAP**.
- 2 Select Delete  beside the LDAP server name that you want to delete.
- 3 Select OK.

Configuring user groups

To enable authentication, you must add user names, RADIUS servers, and LDAP servers to one or more user groups. You can then select a user group when you require authentication. You can select a user group to configure authentication for:

- Policies that require authentication. Only users in the selected user group or users that can authenticate with the RADIUS servers added to the user group can authenticate with these policies.

- IPsec VPN Phase 1 configurations for dialup users. Only users in the selected user group can authenticate to use the VPN tunnel.
- XAuth for IPsec VPN Phase 1 configurations. Only users in the selected user group can be authenticated using XAuth.
- The FortiGate PPTP configuration. Only users in the selected user group can use PPTP.
- The FortiGate L2TP configuration. Only users in the selected user group can use L2TP.

When you add user names, RADIUS servers, and LDAP servers to a user group, the order in which they are added determines the order in which the FortiGate unit checks for authentication. If user names are first, then the FortiGate unit checks for a match with these local users. If a match is not found, the FortiGate unit checks the RADIUS or LDAP server. If a RADIUS or LDAP server is added first, the FortiGate unit checks the server and then the local users.

If the user group contains users, RADIUS servers, and LDAP servers, the FortiGate unit checks them in the order in which they have been added to the user group.

This section describes:

- [Adding user groups](#)
- [Deleting user groups](#)

Adding user groups

Use the following procedure to add user groups to the FortiGate configuration. You can add user names, RADIUS servers, and LDAP servers to user groups.

To add a user group

- 1 Go to **User > User Group**.
- 2 Select New to add a new user group.

Figure 68: Adding a user group

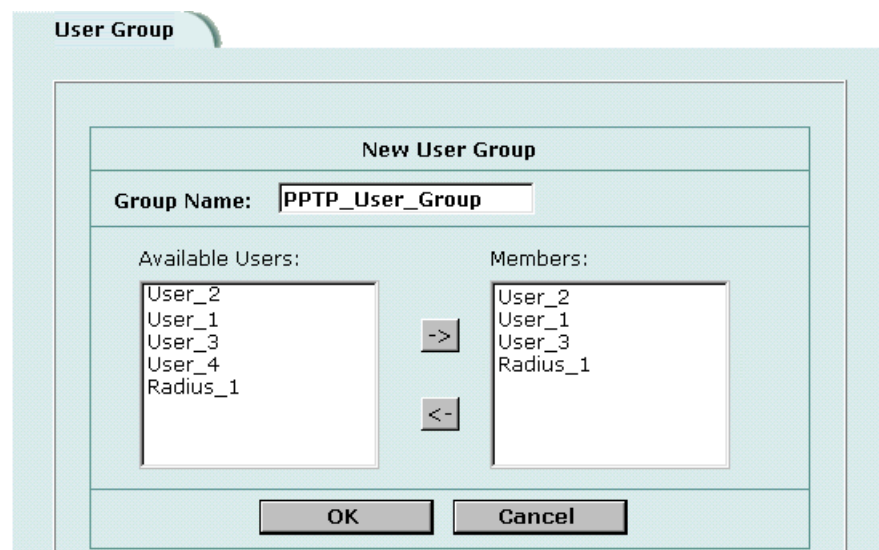

- 3 Enter a Group Name to identify the user group.
The name can contain numbers (0-9), uppercase and lowercase letters (A-Z, a-z), and the special characters - and _. Other special characters and spaces are not allowed.
- 4 To add users to the user group, select a user from the Available Users list and select the right arrow to add the name to the Members list.
- 5 To add a RADIUS server to the user group, select a RADIUS server from the Available Users list and select the right arrow to add the RADIUS server to the Members list.
- 6 To add an LDAP server to the user group, select an LDAP server from the Available Users list and select the right arrow to add the LDAP server to the Members list.
- 7 To remove users, RADIUS servers, or LDAP servers from the user group, select a user, RADIUS server, or LDAP server from the Members list and select the left arrow to remove the name, RADIUS server, or LDAP server from the group.
- 8 Select OK.

Deleting user groups

You cannot delete user groups that have been selected in a policy, a dialup user phase 1 configuration, or a PPTP or L2TP configuration.

To delete a user group

- 1 Go to **User > User Group**
- 2 Select Delete  beside the user group that you want to delete.
- 3 Select OK.

IPSec VPN

A Virtual Private Network (VPN) is an extension of a private network that encompasses links across shared or public networks such as the Internet. For example, a company that has two offices in different cities, each with its own private network, can use a VPN to create a secure tunnel between the offices. Similarly, a teleworker can use a VPN client for remote access to a private office network. In both cases, the secure connection appears to the user as a private network communication, even though the communication is over a public network.

Secure VPN connections are enabled by a combination of tunneling, data encryption, and authentication. Tunneling encapsulates data so that it can be transferred over the public network. Instead of being sent in its original format, the data frames are encapsulated within an additional header and then routed between tunnel endpoints. Upon arrival at the destination endpoint, the data is decapsulated and forwarded to its destination within the private network.

Encryption changes a data stream from clear text (something that a human or a program can interpret) to cipher text (something that cannot be interpreted). The information is encrypted and decrypted using mathematical algorithms known as keys.

Authentication provides a means to verify the origin of a packet and the integrity of its contents. Authentication is done using checksums calculated with keyed hash function algorithms.

This chapter provides an overview about how to configure FortiGate IPSec VPN. For a complete description of FortiGate VPN, see the *FortiGate VPN Guide*.

- [Key management](#)
- [Manual key IPSec VPNs](#)
- [AutoIKE IPSec VPNs](#)
- [Managing digital certificates](#)
- [Configuring encrypt policies](#)
- [IPSec VPN concentrators](#)
- [Monitoring and Troubleshooting VPNs](#)

Key management

There are three basic elements in any encryption system:

- an algorithm that changes information into code,
- a cryptographic key that serves as a secret starting point for the algorithm,
- a management system to control the key.

IPSec provides two ways to handle key exchange and management:

- [Manual Keys](#)
- [Automatic Internet Key Exchange \(AutoIKE\) with pre-shared keys or certificates](#)

Manual Keys

When using manual keys, matching security settings must be entered at both ends of the tunnel. These settings, which include both the encryption and authentication keys, must be kept secret so that unauthorized parties cannot decrypt the data, even if they know which encryption algorithm is being used.

Automatic Internet Key Exchange (AutoIKE) with pre-shared keys or certificates

For using multiple tunnels, an automated system of key management is required. IPSec supports the automated generation and negotiation of keys using the Internet Key Exchange protocol. This method of key management is referred to as AutoIKE. Fortinet supports AutoIKE with pre-shared keys and AutoIKE with certificates.

AutoIKE with pre-shared keys

If both peers in a session are configured with the same pre-shared key, they can use it to authenticate themselves to each other. The peers do not send the key to each other. Instead, as part of the security negotiation process, they use it in combination with a Diffie-Hellman group to create a session key. The session key is used for encryption and authentication and is automatically regenerated by IKE during the communication session.

Pre-shared keys are similar to manual keys in that they require the network administrator to distribute and manage matching information at the VPN peer sites. Whenever a pre-shared key changes, the administrator must update both sites.

AutoIKE with certificates

This method of key management involves a trusted third party, the certificate authority (CA). Each peer in a VPN is first required to generate a set of keys, known as a public/private key pair. The CA signs the public key for each peer, creating a signed digital certificate. The peer then contacts the CA to retrieve their own certificates, plus that of the CA. After the certificates are uploaded to the FortiGate units and appropriate IPSec tunnels and policies are configured, the peers are ready to communicate. As they do, IKE manages the exchange of certificates, sending signed digital certificates from one peer to another. The signed digital certificates are validated by the presence of the CA certificate at each end. With authentication complete, the IPSec tunnel is then established.

In some respects, certificates are simpler to manage than manual keys or pre-shared keys. For this reason, certificates are best suited to large network deployments.

Manual key IPSec VPNs

When using manual keys, complementary security parameters must be entered at both ends of the tunnel. In addition to encryption and authentication algorithms and keys, the security parameter index (SPI) is required. The SPI is an arbitrary value that defines the structure of the communication between the peers. With other methods, the SPI is generated automatically but with the manual key configuration it must be entered as part of the VPN setup.

The encryption and authentication keys must match on the local and remote peers, that is, the SPI values must be mirror images of each other. After you enter these values, the VPN tunnel can start without a need for the authentication and encryption algorithms to be negotiated. Provided you entered correct, complementary values, the tunnels are established between the peers. This means that the tunnel already exists between the peers. As a result, when traffic matches a policy requiring the tunnel, it can be authenticated and encrypted immediately.

- [General configuration steps for a manual key VPN](#)
- [Adding a manual key VPN tunnel](#)

General configuration steps for a manual key VPN

A manual key VPN configuration consists of a manual key VPN tunnel, the source and destination addresses for both ends of the tunnel, and an encrypt policy to control access to the VPN tunnel.

To create a manual key VPN configuration

- 1 Add a manual key VPN tunnel. See [“Adding a manual key VPN tunnel” on page 237](#).
- 2 Configure an encrypt policy that includes the tunnel, source address, and destination address for both ends of the tunnel. See [“Configuring encrypt policies” on page 249](#).

Adding a manual key VPN tunnel

Configure a manual key tunnel to create an IPSec VPN tunnel between the FortiGate unit and a remote IPSec VPN client or gateway that is also using manual key.

To add a manual key VPN tunnel

- 1 Go to **VPN > IPSec > Manual Key**.
- 2 Select New to add a new manual key VPN tunnel.
- 3 Type a VPN Tunnel Name.
The name can contain numbers (0-9), uppercase and lowercase letters (A-Z, a-z), and the special characters - and _. Other special characters and spaces are not allowed.
- 4 Enter the Local SPI.
The Local Security Parameter Index is a hexadecimal number of up to eight digits (digits can be 0 to 9, a to f) in the range bb8 to FFFFFFFF. This number must be added to the Remote SPI at the opposite end of the tunnel.

- 5** Enter the Remote SPI.
The Remote Security Parameter Index is a hexadecimal number of up to eight digits (digits can be 0 to 9, a to f) in the range bb8 to FFFFFFFF. This number must be added to the Local SPI at the opposite end of the tunnel.
- 6** Enter the Remote Gateway.
This is the external IP address of the FortiGate unit or other IPsec gateway at the opposite end of the tunnel.
- 7** Select an Encryption Algorithm from the list.
Use the same algorithm at both ends of the tunnel.
- 8** Enter the Encryption Key.
Each two-character combination entered in hexadecimal format represents one byte. Depending on the encryption algorithm that you select, you might be required to enter the key in multiple segments. Use the same encryption key at both ends of the tunnel.
 - DES** Enter a 16-character (8 byte) hexadecimal number (0-9, A-F).
 - 3DES** Enter a 48-character (24 byte) hexadecimal number (0-9, A-F). Separate the number into three segments of 16 characters.
 - AES128** Enter a 32-character (16 byte) hexadecimal number (0-9, A-F). Separate the number into two segments of 16 characters.
 - AES192** Enter a 48-character (24 byte) hexadecimal number (0-9, A-F). Separate the number into three segments of 16 characters.
 - AES256** Enter a 64-character (32 byte) hexadecimal number (0-9, A-F). Separate the number into four segments of 16 characters.
- 9** Select an Authentication Algorithm from the list.
Use the same algorithm at both ends of the tunnel.
- 10** Enter the Authentication Key.
Each two-character combination entered in hexadecimal format represents one byte. Use the same authentication key at both ends of the tunnel.
 - MD5** Enter a 32-character (16 byte) hexadecimal number (0-9, A-F). Separate the number into two segments of 16 characters.
 - SHA1** Enter a 40-character (20 byte) hexadecimal number (0-9, A-F). Separate the number into two segments—the first of 16 characters; the second of 24 characters.
- 11** Select a concentrator if you want the tunnel to be part of a hub and spoke VPN configuration. See [“Adding a VPN concentrator” on page 255](#).
- 12** Select OK to save the manual key VPN tunnel.

AutoIKE IPSec VPNs

FortiGate units support two methods of Automatic Internet Key Exchange (AutoIKE) for establishing IPSec VPN tunnels: AutoIKE with pre-shared keys and AutoIKE with digital certificates.

- [General configuration steps for an AutoIKE VPN](#)
- [Adding a phase 1 configuration for an AutoIKE VPN](#)
- [Adding a phase 2 configuration for an AutoIKE VPN](#)

General configuration steps for an AutoIKE VPN

An AutoIKE VPN configuration consists of phase 1 and phase 2 configuration parameters, the source and destination addresses for both ends of the tunnel, and an encrypt policy to control access to the VPN tunnel.

To create an AutoIKE VPN configuration



Note: Prior to configuring an AutoIKE VPN that uses digital certificates, you must add the CA and local certificates to the FortiGate unit. For information about digital certificates, see [“Managing digital certificates” on page 246](#).

- 1 Add the phase 1 parameters. See [“Adding a phase 1 configuration for an AutoIKE VPN” on page 239](#).
- 2 Add the phase 2 parameters. See [“Adding a phase 2 configuration for an AutoIKE VPN” on page 244](#).
- 3 Configure an encrypt policy that includes the tunnel, source address, and destination address for both ends of the tunnel. See [“Configuring encrypt policies” on page 249](#).

Adding a phase 1 configuration for an AutoIKE VPN

When you add a phase 1 configuration, you define the terms by which the FortiGate unit and a remote VPN peer (gateway or client) authenticate themselves to each other prior to establishing an IPSec VPN tunnel.

The phase 1 configuration is related to the phase 2 configuration. In phase 1 the VPN peers are authenticated; in phase 2 the tunnel is established. You have the option to use the same phase 1 parameters to establish multiple tunnels. In other words, the same remote VPN peer (gateway or client) can have multiple tunnels to the local VPN peer (the FortiGate unit).

When the FortiGate unit receives an IPSec VPN connection request, it authenticates the VPN peers according to the phase 1 parameters. Then, depending on the source and destination addresses of the request, it starts an IPSec VPN tunnel and applies an encrypt policy.

To add a phase 1 configuration

- 1 Go to **VPN > IPSEC > Phase 1**.
- 2 Select New to add a new phase 1 configuration.

- 3 Type a Gateway Name for the remote VPN peer.
The remote VPN peer can be either a gateway to another network or an individual client on the Internet.
The name can contain numbers (0-9), uppercase and lowercase letters (A-Z, a-z), and the special characters - and _. Other special characters and spaces are not allowed.
- 4 Select a Remote Gateway address type.
 - If the remote VPN peer has a static IP address, select Static IP Address.
 - If the remote VPN peer has a dynamically assigned IP address (DHCP or PPPoE), or if the remote VPN peer has a static IP address that is not required in the peer identification process, select Dialup User.

Depending on the Remote Gateway address type you selected, other fields become available.

Remote Gateway: Static IP Address

IP Address If you select Static IP Address, the IP Address field appears. Enter the IP address of the remote IPsec VPN gateway or client that can connect to the FortiGate unit. This is a mandatory entry.

Remote Gateway: Dialup User

Peer Options If you select Dialup User, the Peer Options become available under Advanced Options. Use the Peer Options to authenticate remote VPN peers with peer IDs during phase 1 negotiations.

- 5 Select Aggressive or Main (ID Protection) mode.
When using aggressive mode, the VPN peers exchange identifying information in the clear. When using main mode, identifying information is hidden.
The VPN peers must use the same mode.
- 6 Configure the P1 Proposal.
Select up to three encryption and authentication algorithm combinations to propose for phase 1.
The VPN peers must use the same P1 proposal settings.
- 7 Select the DH Group(s).
Select one or more Diffie-Hellman groups to propose for phase 1.
As a general rule, the VPN peers should use the same DH Group settings.
- 8 Enter the Keylife.
The keylife is the amount of time in seconds before the phase 1 encryption key expires. When the key expires, a new key is generated without interrupting service. P1 proposal keylife can be from 120 to 172,800 seconds.
- 9 For Authentication Method, select Preshared Key or RSA Signature.
 - Preshared Key: Enter a key that is shared by the VPN peers. The key must contain at least 6 printable characters and should only be known by network administrators. For optimum protection against currently known attacks, make sure the key consists of a minimum of 16 randomly chosen alphanumeric characters.
 - RSA Signature: Select a local certificate that has been digitally signed by the certificate authority (CA). To add a local certificate to the FortiGate unit, see [“Obtaining a signed local certificate” on page 246](#).

- 10** Configure the Local ID the that the FortiGate unit sends to the remote VPN peer.
- **Preshared key:** If the FortiGate unit is functioning as a client and uses its ID to authenticate itself to the remote VPN peer, enter an ID. If no ID is specified, the FortiGate unit transmits its IP address.
 - **RSA Signature:** No entry is required because the Local ID field contains the Distinguished Name (DN) of the certificate associated with this phase 1 configuration. The DN identifies the owner of the certificate and includes, as a minimum, a Common Name (CN). The DN is transmitted in place of an ID or IP address.

Configuring advanced options

To configure phase 1 advanced options

- 1** Select Advanced Options.
- 2** Select a Peer Option if you want to authenticate remote VPN peers by the ID that they transmit during phase 1.

Accept any peer ID Select to accept any peer ID (and therefore not authenticate remote VPN peers by peer ID).

Accept this peer ID Select to authenticate a specific VPN peer or a group of VPN peers with a shared user name (ID) and password (pre-shared key). Also add the peer ID.

Accept peer ID in dialup group Select to authenticate each remote VPN peer with a unique user name (ID) and password (pre-shared key). Also select a dialup group (user group). Configure the user group prior to configuring this peer option.

- 3** Optionally, configure XAuth.
XAuth (IKE eXtended Authentication) authenticates VPN peers at the user level. If the the FortiGate unit (the local VPN peer) is configured as an XAuth server, it authenticates remote VPN peers by referring to a user group. The users contained in the user group can be configured locally on the FortiGate unit or on remotely located LDAP or RADIUS servers. If the FortiGate unit is configured as an XAuth client, it provides a user name and password when it is challenged.

XAuth: Enable as a Client

Name Enter the user name the local VPN peer uses to authenticate itself to the remote VPN peer.

Password Enter the password the local VPN peer uses to authenticate itself to the remote VPN peer.

XAuth: Enable as a Server

- | | |
|--------------------------|--|
| Encryption method | <p>Select the encryption method used between the XAuth client, the FortiGate unit and the authentication server.</p> <p>PAP— Password Authentication Protocol.</p> <p>CHAP—Challenge-Handshake Authentication Protocol.</p> <p>MIXED—Select MIXED to use PAP between the XAuth client and the FortiGate unit, and CHAP between the FortiGate unit and the authentication server.</p> <p>Use CHAP whenever possible. Use PAP if the authentication server does not support CHAP. (Use PAP with all implementations of LDAP and some implementations of Microsoft RADIUS). Use MIXED if the authentication server supports CHAP but the XAuth client does not. (Use MIXED with the Fortinet Remote VPN Client.)</p> |
| Usergroup | <p>Select a group of users to be authenticated by XAuth. The individual users within the group can be authenticated locally or by one or more LDAP or RADIUS servers.</p> <p>The user group must be added to the FortiGate configuration before it can be selected here.</p> |
- 4** Optionally, configure NAT Traversal.
- | | |
|----------------------------|---|
| Enable | Select Enable if you expect the IPsec VPN traffic to go through a gateway that performs NAT. If no NAT device is detected, enabling NAT traversal has no effect. Both ends of the VPN (both VPN peers) must have the same NAT traversal setting. |
| Keepalive Frequency | If you enable NAT-traversal, you can change the number of seconds in the Keepalive Frequency field. This number specifies, in seconds, how frequently empty UDP packets are sent through the NAT device to ensure that the NAT mapping does not change until P1 and P2 keylife expires. The keepalive frequency can be from 0 to 900 seconds. |
- 5** Optionally, configure Dead Peer Detection.
- Use these settings to monitor the status of the connection between VPN peers. DPD allows dead connections to be cleaned up and new VPN tunnels established. DPD is not supported by all vendors.
- | | |
|-----------------------|---|
| Enable | Select Enable to enable DPD between the local and remote peers. |
| Short Idle | Set the time, in seconds, that a link must remain unused before the local VPN peer considers it to be idle. After this period of time expires, whenever the local peer sends traffic to the remote VPN peer it also sends a DPD probe to determine the status of the link. To control the length of time that the FortiGate unit takes to detect a dead peer with DPD probes, configure the Retry Count and the Retry Interval. |
| Retry Count | Set the number of times that the local VPN peer retries the DPD probe before it considers the channel to be dead and tears down the security association (SA). To avoid false negatives because of congestion or other transient failures, set the retry count to a sufficiently high value for your network. |
| Retry Interval | Set the time, in seconds, that the local VPN peer unit waits between retrying DPD probes. |
| Long Idle | Set the time, in seconds, that a link must remain unused before the local VPN peer pro-actively probes its state. After this period of time expires, the local peer sends a DPD probe to determine the status of the link even if there is no traffic between the local peer and the remote peer. |
- 6** Select OK to save the phase 1 parameters.

Figure 69: Adding a phase 1 configuration (Standard options)

The screenshot shows the 'New VPN Gateway' configuration window with the following settings:

- Gateway Name:** Remote_Client_3
- Remote Gateway:** Dialup User
- Mode:** Aggressive Main (ID protection)
- P1 Proposal:**
 - 1 - Encryption: [AES] Authentication: [SHA1]
 - 2 - Encryption: [AES] Authentication: [MD5]
- DH Group:** 1 2 5
- Keylife:** [28800] (seconds)
- Authentication Method:** [RSA Signature]
- Certificate Name:** [Local_FGI_certificate]
- Local ID:** [] (optional)
- Advanced Options:** (Dialup Group, Peer, XAUTH, Nat Traversal, DPD)
- Peer Options:**
 - Accept any peer ID
 - Accept this peer ID []
 - Accept peer ID in dialup group [None]
- XAuth:** Disable Enable as Client Enable as Server
- Nat-traversal:** Enable
- Keepalive Frequency:** [5] (seconds)
- Dead Peer Detection:** Enable
 - Short Idle: [10] (seconds)
 - Retry Count: [3] (times)
 - Retry Interval: [5] (seconds)
 - Long Idle: [300] (seconds)

Figure 70: Adding a phase 1 configuration (Advanced options)

The screenshot shows the 'Advanced Options' section of the configuration window with the following settings:

- Peer Options:**
 - Accept any peer ID
 - Accept this peer ID []
 - Accept peer ID in dialup group [Gregory]
- XAuth:** Disable Enable as Client Enable as Server
- Nat-traversal:** Enable
- Keepalive Frequency:** [5] (0-900 seconds)
- Dead Peer Detection:** Enable
 - Short Idle: [10] (1-300 seconds)
 - Retry Count: [3] (0-10 times)
 - Retry Interval: [5] (1-60 seconds)
 - Long Idle: [300] (101-28800 seconds)

Adding a phase 2 configuration for an AutoIKE VPN

Add a phase 2 configuration to specify the parameters used to create and maintain a VPN tunnel between the local VPN peer (the FortiGate unit) and the remote VPN peer (the VPN gateway or client).



Note: Adding a Phase 2 configuration is the same for pre-shared key and certification VPNs.

To add a phase 2 configuration

- 1 Go to **VPN > IPSEC > Phase 2**.
- 2 Select New to add a new phase 2 configuration.
- 3 Enter a Tunnel Name.
The name can contain numbers (0-9), uppercase and lowercase letters (A-Z, a-z), and the special characters - and _. Other special characters and spaces are not allowed.
- 4 Select a Remote Gateway to associate with the VPN tunnel.
A remote gateway can be either a gateway to another network or an individual client on the Internet. Remote gateways are added as part of the phase 1 configuration. For details, see [“Adding a phase 1 configuration for an AutoIKE VPN” on page 239](#).
Choose either a single DIALUP remote gateway, or up to three STATIC remote gateways. Multiple STATIC remote gateways are necessary if you are configuring IPsec redundancy.
- 5 Configure the P2 Proposal.
Select up to three encryption and authentication algorithm combinations to propose for phase 2.
The VPN peers must use the same P2 proposal settings.
- 6 Optionally, enable Replay Detection.
Replay detection protects the VPN tunnel from replay attacks.



Note: Do not select replay detection if you have also selected Null Authentication for the P2 Proposal.

- 7 Optionally, enable Perfect Forward Secrecy (PFS).
PFS improves security by forcing a new Diffie-Hellman exchange whenever keylife expires.
- 8 Select the DH Group(s).
The VPN peers must use the same DH Group settings.
- 9 Enter the Keylife.
The keylife causes the phase 2 key to expire after a specified time, after a specified number of Kbytes of data have been processed by the VPN tunnel, or both. If you select both, the key does not expire until both the time has passed and the number of Kbytes have been processed.
When the key expires, a new key is generated without interrupting service. P2 proposal keylife can be from 120 to 172800 seconds or from 5120 to 99999 Kbytes.

- 10 Enable Autokey Keep Alive if you want to keep the VPN tunnel running even if no data is being processed.
- 11 Select a concentrator if you want the tunnel to be part of a hub and spoke VPN configuration.
If you use the procedure, [“Adding a VPN concentrator” on page 255](#) to add the tunnel to a concentrator, the next time you open the tunnel, the Concentrator field displays the name of the concentrator to which you added the tunnel.
- 12 Select a Quick Mode Identity.
 - Use selectors from policy** Select this option for policy-based VPNs. A policy-based VPN uses an encrypt policy to select which VPN tunnel to use for the connection. In this configuration, the VPN tunnel is referenced directly from the encrypt policy. You must select this option if both VPN peers are FortiGate units.
 - Use wildcard selectors** Select this option for routing-based VPNs. A routing-based VPN uses routing information to select which VPN tunnel to use for the connection. In this configuration, the tunnel is referenced indirectly by a route that points to a tunnel interface. You must select this option if the remote VPN peer is a non-FortiGate unit that has been configured to operate in tunnel interface mode.
- 13 Select OK to save the AutoIKE key VPN tunnel.

Figure 71: Adding a phase 2 configuration

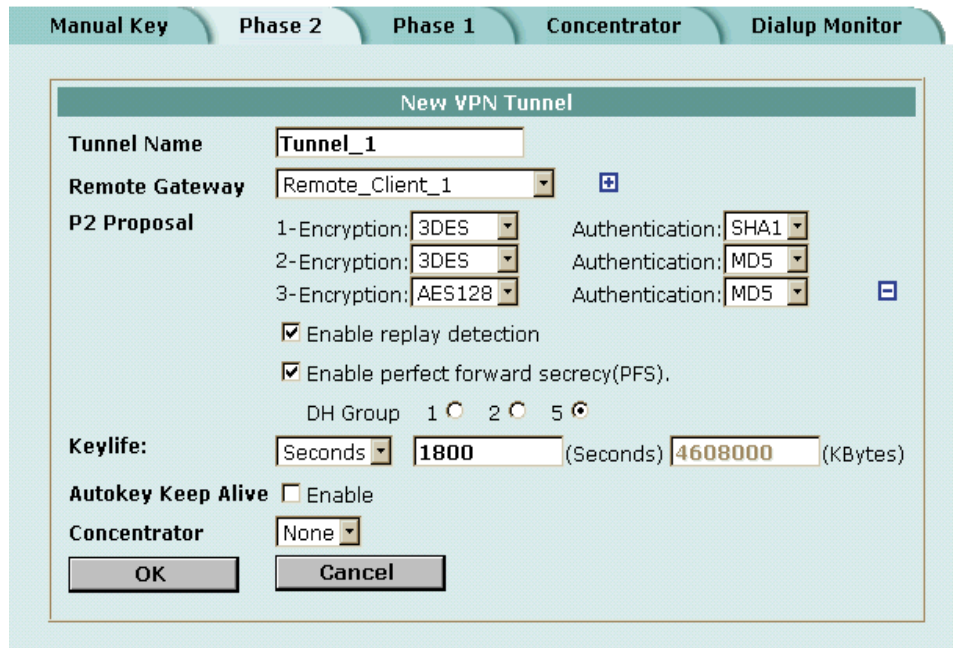

Managing digital certificates

Use digital certificates to make sure that both participants in an IPSec communication session are trustworthy, prior to setting up an encrypted VPN tunnel between the participants.

Fortinet uses a manual procedure to obtain certificates. This involves copying and pasting text files from your local computer to the certificate authority, and from the certificate authority to your local computer.

- [Obtaining a signed local certificate](#)
- [Obtaining CA certificates](#)



Note: Digital certificates are not required for configuring FortiGate VPNs. Digital certificates are an advanced feature provided for the convenience of system administrators. This manual assumes the user has prior knowledge of how to configure digital certificates for their implementation.

Obtaining a signed local certificate

The signed local certificate provides the FortiGate unit with a means to authenticate itself to other devices.



Note: The VPN peers must use digital certificates that adhere to the X.509 standard.

Generating the certificate request

With this procedure, you generate a private and public key pair. The public key is the base component of the certificate request.

To generate the certificate request

- 1 Go to **VPN > Certificates > Local Certificates**.
- 2 Select **Generate**.
- 3 Type a **Certificate Name**.

The name can contain numbers (0-9), uppercase and lowercase letters (A-Z, a-z), and the special characters - and _. Other special characters and spaces are not allowed.

- 4 Configure the **Subject Information** that identifies the object being certified. Preferably use an IP address or domain name. If this is impossible (such as with a dialup client), use an email address.

Host IP	For Host IP, enter the IP address of the FortiGate unit being certified.
Domain Name	For Domain name, enter the fully qualified domain name of the FortiGate unit being certified. Do not include the protocol specification (http://) or any port number or path names.
E-Mail	For E-mail, enter the email address of the owner of the FortiGate unit being certified. Typically, e-mail addresses are entered only for clients, not gateways.

- 5 Configure the **Optional Information** to further identify the object being certified.

- Organization Unit** Enter a name that identifies the department or unit within the organization that is requesting the certificate for the FortiGate unit (such as Manufacturing or MF).
- Organization** Enter the legal name of the organization that is requesting the certificate for the FortiGate unit (such as Fortinet).
- Locality** Enter the name of the city or town where the FortiGate unit is located (such as Vancouver).
- State/Province** Enter the name of the state or province where the FortiGate unit is located (such as California or CA).
- Country** Select the country where the FortiGate unit is located.
- e-mail** Enter a contact email address for the FortiGate unit. Typically, email addresses are entered only for clients, not gateways.

6 Configure the key.

- Key Type** Select RSA as the key encryption type. No other key type is supported.
- Key Size** Select 1024 Bit, 1536 Bit or 2048 Bit. Larger keys are slower to generate but more secure. Not all IPSec VPN products support all three key sizes.

7 Select OK to generate the private and public key pair and the certificate request.

The private/public key pair are generated and the certificate request is displayed on the Local Certificates list with a status of Pending.

Figure 72: Adding a Local Certificate

The screenshot shows a 'Generate Certificate Signing Request' dialog box. It is divided into several sections:

- Certification Name:** A text field containing 'User_One'.
- Subject Information:**
 - ID Type: A dropdown menu set to 'E-Mail'.
 - e-mail: A text field containing 'one@fortinet.com'.
- Optional Information:**
 - Organization Unit: Text field 'MF'.
 - Organization: Text field 'Fortinet'.
 - Locality(City): Text field 'Vancouver'.
 - State/Province: Text field 'BC'.
 - Country: A dropdown menu set to 'CANADA'.
 - e-mail: An empty text field.
- Key Type:** A dropdown menu set to 'RSA'.
- Key Size:** A dropdown menu set to '1024 Bit'.

At the bottom of the dialog are two buttons: 'OK' and 'Cancel'.

Downloading the certificate request

Use the following procedure to download a certificate request from the FortiGate unit to the management computer.

To download the certificate request

- 1 Go to **VPN > Certificates > Local Certificates**.
- 2 Select Download  to download the local certificate to the management computer.
- 3 Select Save.
- 4 Name the file and save it in a directory on the management computer.

After downloading the certificate request, you can submit it to your CA so that your CA can sign the certificate.

Importing the signed local certificate

With this procedure, you import the signed local certificate from the management computer to the FortiGate unit.

To import the signed local certificate

- 1 Go to **VPN > Certificates > Local Certificates**.
- 2 Select Import.
- 3 Enter the path or browse to locate the signed local certificate on the management computer.
- 4 Select OK.

The signed local certificate is displayed on the Local Certificates list with a status of OK.

Backing up and restoring the local certificate and private key

When you back up a FortiGate configuration that includes IPSec VPN tunnels using certificates, you must also back up the local certificate and private key in a password-protected PKCS12 file. Before restoring the configuration, you must import the PKCS12 file and set the local certificate name to the same that was in the original configuration.

Public Key Cryptography Standard 12 (PKCS12) describes the syntax for securely exchanging personal information.



Note: Use the `execute vpn certificates key` CLI command to back up and restore the local certificate and private key. For more information, see the *FortiGate CLI Reference Guide*.

Obtaining CA certificates

For the VPN peers to authenticate themselves to each other, they must both obtain a CA certificate from the same certificate authority. The CA certificate provides the VPN peers with a means to validate the digital certificates that they receive from other devices.

The FortiGate unit obtains the CA certificate to validate the digital certificate that it receives from the remote VPN peer. The remote VPN peer obtains the CA certificate to validate the digital certificate that it receives from the FortiGate unit.



Note: The CA certificate must adhere to the X.509 standard.

Importing CA certificates

Import the CA certificate from the management computer to the FortiGate unit.

To import the CA certificate

- 1 Go to **VPN > Certificates > CA Certificates**.
- 2 Select Import.
- 3 Enter the path or browse to locate the CA certificate on the management computer.
- 4 Select OK.

The CA is displayed on the CA Certificates list.

The system assigns a unique name to each CA certificate. The names are numbered consecutively (CA_Cert_1, CA_Cert_2, CA_Cert_3, and so on).

Configuring encrypt policies

A VPN connects the local, internal network to a remote, external network. The principal role of the encrypt policy is to define (and limit) which addresses on these networks can use the VPN.

A VPN requires only one encrypt policy to control both inbound and outbound connections. Depending on how you configure it, the policy controls whether users on your internal network can establish a tunnel to the remote network (the outbound connection), and whether users on the remote network can establish a tunnel to your internal network (the inbound connection). This flexibility allows one encrypt policy to do the same function as two regular firewall policies.

Although the encrypt policy controls both incoming and outgoing connections, it must always be configured as an outgoing policy. An outgoing policy has a source address on an internal network and a destination address on an external network. The source address identifies the addresses on the internal network that are part of the VPN. The destination address identifies the addresses on the remote network that are part of the VPN.



Note: The destination address can be a VPN client address on the Internet or the address of a network behind a remote VPN gateway.

In addition to defining membership in the VPN by address, you can configure the encrypt policy for services such as DNS, FTP, and POP3, and to allow connections according to a predefined schedule (by the time of the day or the day of the week, month, or year). You can also configure the encrypt policy for:

- Inbound NAT to translate the source of incoming packets.
- Outbound NAT to translate the source address of outgoing packets.
- Traffic shaping to control the bandwidth available to the VPN and the priority of the VPN.
- Content profiles to apply antivirus protection, web filtering, and email filtering to web, file transfer, and email services in the VPN.
- Logging so that the FortiGate unit logs all connections that use the VPN.

The policy must also include the VPN tunnel that you created to communicate with the remote FortiGate VPN gateway. When users on your internal network attempt to connect to the network behind the remote VPN gateway, the encrypt policy intercepts the connection attempt and starts the VPN tunnel added to the policy. The tunnel uses the remote gateway added to its configuration to connect to the remote VPN gateway. When the remote VPN gateway receives the connection attempt, it checks its own policy, gateway, and tunnel configuration. If the configuration is allowed, an IPSec VPN tunnel is negotiated between the two VPN peers.

- [Adding a source address](#)
- [Adding a destination address](#)
- [Adding an encrypt policy](#)

Adding a source address

The source address is located within the internal network of the local VPN peer. It can be a single computer address or the address of a network.

To add a source address

- 1 Go to **Firewall > Address**.
- 2 Select an internal interface.
- 3 Select New to add an address.
- 4 Enter the Address Name, IP Address, and NetMask for a single computer or for an entire subnetwork on an internal interface of the local VPN peer.
- 5 Select OK to save the source address.

Adding a destination address

The destination address can be a VPN client address on the Internet or the address of a network behind a remote VPN gateway.

To add a destination address

- 1 Go to **Firewall > Address**.
- 2 Select an external interface.
- 3 Select New to add an address.
- 4 Enter the Address Name, IP Address, and NetMask for a single computer or for an entire subnetwork on an internal interface of the remote VPN peer.
- 5 Select OK to save the destination address.

Adding an encrypt policy

To add an encrypt policy

- 1 Go to **Firewall > Policy**.
- 2 Select the policy list that you want to add the policy to (usually, Internal->External).
- 3 Select New to add a new policy.
- 4 Set Source to the source address.
- 5 Set Destination to the destination address.
- 6 Set Service to control the services allowed over the VPN connection.
You can select ANY to allow all supported services over the VPN connection or select a specific service or service group to limit the services allowed over the VPN connection.
- 7 Set Action to ENCRYPT.
- 8 Configure the ENCRYPT parameters.

VPN Tunnel	Select an Auto Key tunnel for this encrypt policy.
Allow inbound	Select Allow inbound to enable inbound users to connect to the source address.
Allow outbound	Select Allow outbound to enable outbound users to connect to the destination address.
Inbound NAT	The FortiGate unit translates the source address of incoming packets to the IP address of the FortiGate interface connected to the source address network. Typically, this is an internal interface of the FortiGate unit. Inbound NAT makes it impossible for local hosts to see the IP addresses of remote hosts (hosts located on the network behind the remote VPN gateway).
Outbound NAT	The FortiGate unit translates the source address of outgoing packets to the IP address of the FortiGate interface connected to the destination address network. Typically, this is an external interface of the FortiGate unit. Outbound NAT makes it impossible for remote hosts to see the IP addresses of local hosts (hosts located on the network behind the local VPN gateway). If Outbound NAT is implemented, it is subject to these limitations: Configure Outbound NAT only at one end of the tunnel. The end that does not implement Outbound NAT requires an internal to external policy that specifies the remote external interface as the Destination (usually a public IP address). The tunnel, and the traffic within the tunnel, can only be initiated at the end that implements Outbound NAT.

For information about configuring the remaining policy settings, see [“Adding firewall policies” on page 194](#).

9 Select OK to save the encrypt policy.

To make sure that the encrypt policy is matched for VPN connections, arrange the encrypt policy above other policies with similar source and destination addresses and services in the policy list.

Figure 73: Adding an encrypt policy

The screenshot shows the 'Edit Policy' configuration window in FortiGate. The window has tabs for different traffic directions: Int->Ext, Int->DMZ, DMZ->Int, DMZ->Ext, Ext->Int, and Ext->DMZ. The 'Int->DMZ' tab is selected. The configuration is as follows:

- Source:** FGT-100
- Destination:** FGT_60
- Schedule:** Always
- Service:** ANY
- Action:** ENCRYPT
- VPN Tunnel:** FGT-60
- Allow inbound
- Inbound NAT
- Allow outbound
- Outbound NAT
- Traffic Shaping
 - Guaranteed Bandwidth: 0 (KBytes/s)
 - Maximum Bandwidth: 0 (KBytes/s)
 - Traffic Priority: High
- Anti-virus & Web filter
 - Content Profile: Strict
- Log Traffic
- Comments:** maximum 63 chars

At the bottom, there are 'OK' and 'Cancel' buttons.

IPSec VPN concentrators

In a hub-and-spoke network, all VPN tunnels terminate at a single VPN peer called a hub. The peers that connect to the hub are known as spokes. The hub functions as a concentrator on the network, managing the VPN connections between the spokes.

The advantage of a hub-and-spoke network is that the spokes are simpler to configure because they require fewer policy rules. Also, a hub-and-spoke network provides some processing efficiencies, particularly on the spokes. The disadvantage of a hub-and-spoke network is its reliance on a single peer to handle management of all VPNs. If this peer fails, encrypted communication in the network is impossible.

A hub-and-spoke VPN network requires a special configuration. Setup varies depending on the role of the VPN peer.

If the VPN peer is a FortiGate unit functioning as the hub, or concentrator, it requires a VPN configuration connecting it to each spoke (AutoIKE phase 1 and 2 settings or manual key settings, plus encrypt policies). It also requires a concentrator configuration that groups the hub-and-spoke tunnels together. The concentrator configuration defines the FortiGate unit as the hub in a hub-and-spoke network.

If the VPN peer is one of the spokes, it requires a tunnel connecting it to the hub (but not to the other spokes). It also requires policies that control its encrypted connections to the other spokes and its non-encrypted connections to other networks, such as the Internet.

- [VPN concentrator \(hub\) general configuration steps](#)
- [Adding a VPN concentrator](#)
- [VPN spoke general configuration steps](#)

VPN concentrator (hub) general configuration steps

A central FortiGate that is functioning as a hub requires the following configuration:

- A tunnel (AutoIKE phase 1 and phase 2 configuration or manual key configuration) for each spoke.
- Destination addresses for each spoke.
- A concentrator configuration.
- An encrypt policy for each spoke.

To create a VPN concentrator configuration

- 1 Configure one of the following tunnels for each spoke:
 - A manual key tunnel consists of a name for the tunnel, the IP address of the spoke (client or gateway) at the opposite end of the tunnel, and the encryption and authentication algorithms to use for the tunnel.
See [“Manual key IPSec VPNs” on page 237](#).
 - An AutoIKE tunnel consists of phase 1 and phase 2 parameters. The phase 1 parameters include the name of the spoke (client or gateway), designation of how the spoke receives its IP address (static or dialup), encryption and authentication algorithms, and the authentication method (either pre-shared keys or PKI certificates). The phase 2 parameters include the name of the tunnel, selection of the spoke (client or gateway) configured in phase 1, encryption and authentication algorithms, and a number of security parameters.
See [“AutoIKE IPSec VPNs” on page 239](#).
 - 2 Add a destination address for each spoke. The destination address is the address of the spoke (either a client on the Internet or a network located behind a gateway).
See [“Adding a source address” on page 250](#).
 - 3 Add the concentrator configuration. This step groups the tunnels together on the FortiGate unit. The tunnels link the hub to the spokes. The tunnels are added as part of the AutoIKE phase 2 configuration or the manual key configuration.
See [“Adding a VPN concentrator” on page 255](#).
-  **Note:** Add the concentrator configuration to the central FortiGate unit (the hub) after adding the tunnels for all spokes.
- 4 Add an encrypt policy for each spoke. Encrypt policies control the direction of traffic through the hub and allow inbound and outbound VPN connections between the hub and the spokes. The encrypt policy for each spoke must include the tunnel name of the spoke. The source address must be Internal_All. Use the following configuration for the encrypt policies:

- Source** Internal_All
- Destination** The VPN spoke address.
- Action** ENCRYPT
- VPN Tunnel** The VPN spoke tunnel name.
- Allow inbound** Select allow inbound.
- Allow outbound** Select allow outbound
- Inbound NAT** Select inbound NAT if required.
- Outbound NAT** Select outbound NAT if required.

See [“Adding an encrypt policy” on page 251](#).

- 5 Arrange the policies in the following order:
 - encrypt policies
 - default non-encrypt policy (Internal_All -> External_All)

Adding a VPN concentrator

To add a VPN concentrator configuration

- 1 Go to **VPN > IPSec > Concentrator**.
- 2 Select New to add a VPN concentrator.
- 3 Enter the name of the new concentrator in the Concentrator Name field.
- 4 To add tunnels to the VPN concentrator, select a VPN tunnel from the Available Tunnels list and select the right arrow.
- 5 To remove tunnels from the VPN concentrator, select the tunnel in the Members list and select the left arrow.
- 6 Select OK to add the VPN concentrator.

Figure 74: Adding a VPN concentrator

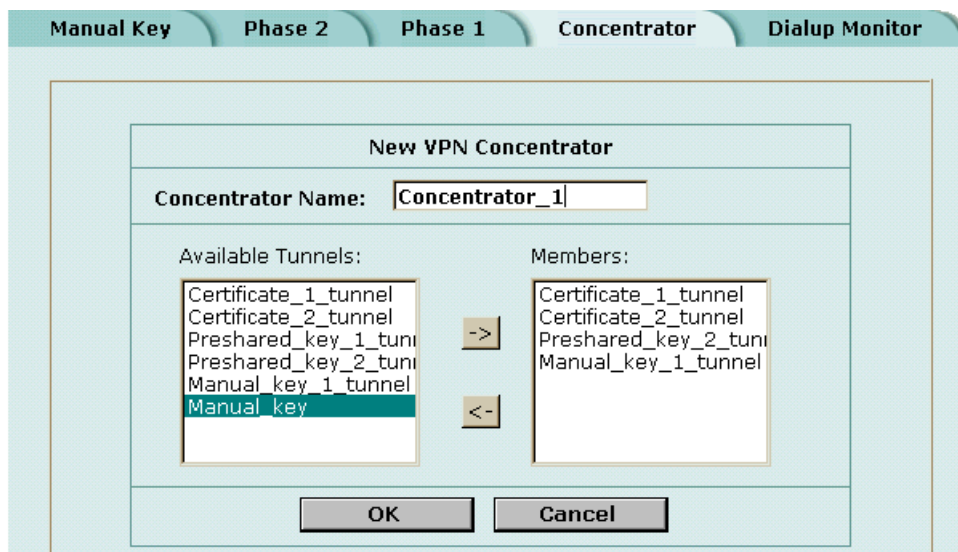

VPN spoke general configuration steps

A remote VPN peer that functions as a spoke requires the following configuration:

- A tunnel (AutoIKE phase 1 and phase 2 configuration or manual key configuration) for the hub.
- The source address of the local VPN spoke.
- The destination address of each remote VPN spoke.
- A separate outbound encrypt policy for each remote VPN spoke. These policies allow the local VPN spoke to initiate encrypted connections.
- A single inbound encrypt policy. This policy allows the local VPN spoke to accept encrypted connections.

To create a VPN spoke configuration

- 1 Configure a tunnel between the spoke and the hub.
Choose between a manual key tunnel or an AutoIKE tunnel.
 - To add a manual key tunnel, see [“Manual key IPSec VPNs” on page 237](#).
 - To add an AutoIKE tunnel, see [“AutoIKE IPSec VPNs” on page 239](#).
- 2 Add the source address. One source address is required for the local VPN spoke.
See [“Adding a source address” on page 250](#).
- 3 Add a destination address for each remote VPN spoke. The destination address is the address of the spoke (either a client on the Internet or a network located behind a gateway).
See [“Adding a destination address” on page 251](#).
- 4 Add a separate outbound encrypt policy for each remote VPN spoke. These policies control the encrypted connections initiated by the local VPN spoke.
The encrypt policy must include the appropriate source and destination addresses and the tunnel added in step 1. Use the following configuration:

Source	The local VPN spoke address.
Destination	The remote VPN spoke address.
Action	ENCRYPT
VPN Tunnel	The VPN tunnel name added in step 1. (Use the same tunnel for all encrypt policies.)
Allow inbound	Do not enable.
Allow outbound	Select allow outbound
Inbound NAT	Select inbound NAT if required.
Outbound NAT	Select outbound NAT if required.

See [“Adding an encrypt policy” on page 251](#).

- 5 Add an inbound encrypt policy. This policy controls the encrypted connections initiated by the remote VPN spokes.
The encrypt policy for the hub must include the appropriate source and destination addresses and the tunnel added in step 1. Use the following configuration:

Source	The local VPN spoke address.
Destination	External_All

- Action** ENCRYPT
- VPN Tunnel** The VPN tunnel name added in step 1. (Use the same tunnel for all encrypt policies.)
- Allow inbound** Select allow inbound.
- Allow outbound** Do not enable.
- Inbound NAT** Select inbound NAT if required.
- Outbound NAT** Select outbound NAT if required.

See “Adding an encrypt policy” on page 251.

- 6 Arrange the policies in the following order:
 - outbound encrypt policies
 - inbound encrypt policy
 - default non-encrypt policy (Internal_All -> External_All)



Note: The default non-encrypt policy is required to allow the VPN spoke to access other networks, such as the Internet.

Monitoring and Troubleshooting VPNs

- [Viewing VPN tunnel status](#)
- [Viewing dialup VPN connection status](#)
- [Testing a VPN](#)

Viewing VPN tunnel status

You can use the IPSec VPN tunnel list to view the status of all IPSec AutoIKE key VPN tunnels. For each tunnel, the list shows the status and the tunnel time out.

To view VPN tunnel status

- 1 Go to **VPN > IPSEC > Phase 2**.
- 2 View the status and timeout for each VPN tunnel.

- Status** The status of each tunnel. If Status is Up, the tunnel is active. If Status is Down, the tunnel is not active. If Status is Connecting, the tunnel is attempting to start a VPN connection with a remote VPN gateway or client.
- Timeout** The time before the next key exchange. The time is calculated by subtracting the time elapsed since the last key exchange from the keylife.

Figure 75: AutoIKE key tunnel status

Manual Key						Phase 2						Phase 1						Concentrator						Dialup Monitor					
Tunnel Name	Remote Gateway	Lifetime(sec/kb)	Status	Timeout	Modify																								
AutoIKE_tunnel_1	66.34.23.78	300/10240	Up	87																									
AutoIKE_tunnel_2	55.66.77.88	300/NA	Down	0																									

New

Viewing dialup VPN connection status

You can use the dialup monitor to view the status of dialup VPNs. The dialup monitor lists the remote gateways and the active VPN tunnels for each gateway. The monitor also lists the tunnel lifetime, timeout, proxy ID source, and proxy ID destination for each tunnel.

To view dialup connection status

- 1 Go to **VPN > IPSec > Dialup Monitor**.
- 2 View the dialup connection status information for the FortiGate unit:

Remote gateway The IP address of the remote dialup remote gateway on the FortiGate unit.

Lifetime The amount of time that the dialup VPN connection has been active.

Timeout The time before the next key exchange. The time is calculated by subtracting the time elapsed since the last key exchange from the keylife.

Proxy ID Source The actual IP address or subnet address of the remote peer.

Proxy ID Destination The actual IP address or subnet address of the local peer.

Figure 76: Dialup Monitor

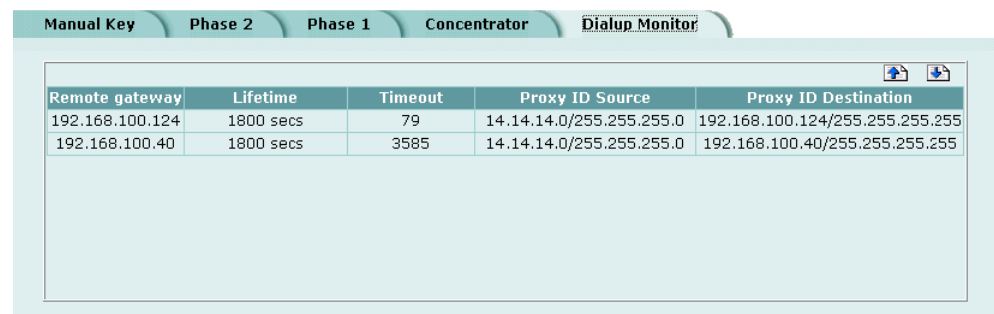

Remote gateway	Lifetime	Timeout	Proxy ID Source	Proxy ID Destination
192.168.100.124	1800 secs	79	14.14.14.0/255.255.255.0	192.168.100.124/255.255.255.255
192.168.100.40	1800 secs	3585	14.14.14.0/255.255.255.0	192.168.100.40/255.255.255.255

Testing a VPN

To confirm that a VPN between two networks has been configured correctly, use the ping command from one internal network to connect to a computer on the other internal network. The IPSec VPN tunnel starts automatically when the first data packet destined for the VPN is intercepted by the FortiGate unit.

To confirm that a VPN between a network and one or more clients has been configured correctly, start a VPN client and use the ping command to connect to a computer on the internal network. The VPN tunnel initializes automatically when the client makes a connection attempt. You can start the tunnel and test it at the same time by pinging from the client to an address on the internal network.

PPTP and L2TP VPN

You can use PPTP and L2TP to create a virtual private network (VPN) between a remote client computer that is running Windows and your internal network. Because PPTP and L2TP are supported by Windows you do not require third-party software on the client computer. Provided your ISP supports PPTP and L2TP connections, you can create a secure connection by making some configuration changes to the client computer and the FortiGate unit.

This chapter provides an overview of how to configure FortiGate PPTP and L2TP VPN. For a complete description of FortiGate PPTP and L2TP, see the *FortiGate VPN Guide*.

This chapter describes:

- [Configuring PPTP](#)
- [Configuring L2TP](#)

Configuring PPTP

Point-to-Point protocol (PPTP) packages data within PPP packets and then encapsulates the PPP packets within IP packets for transmission through a VPN tunnel.



This section describes:

- [Configuring the FortiGate unit as a PPTP gateway](#)
- [Configuring a Windows 98 client for PPTP](#)
- [Configuring a Windows 2000 client for PPTP](#)
- [Configuring a Windows XP client for PPTP](#)

Configuring the FortiGate unit as a PPTP gateway

Use the following procedures to configure the FortiGate unit as a PPTP gateway:

To add users and user groups

Add a user for each PPTP client.

- 1 Go to **User > Local**.
- 2 Add and configure PPTP users.
For information about adding and configuring users, see [“Adding user names and configuring authentication” on page 228](#).
- 3 Go to **User > User Group**.
- 4 Add and configure PPTP user groups.
For information about adding and configuring user groups, see [“Configuring user groups” on page 232](#).

To enable PPTP and specify an address range

- 1 Go to **VPN > PPTP > PPTP Range**.
- 2 Select Enable PPTP.
- 3 Enter the Starting IP and the Ending IP for the PPTP address range.
- 4 Select the User Group that you added in [“To add users and user groups” on page 260](#).
- 5 Select Apply to enable PPTP through the FortiGate unit.

Figure 77: Example PPTP Range configuration

PPTP Range

Enable PPTP

Starting IP:

Ending IP:

User Group:

Disable PPTP

To add a source address

Add a source address for every address in the PPTP address range.

- 1 Go to **Firewall > Address**.
- 2 Select the interface to which PPTP clients connect.
This can be an interface, VLAN subinterface, or zone.

- 3 Select New to add an address.
- 4 Enter the Address Name, IP Address, and NetMask for an address in the PPTP address range.
- 5 Select OK to save the source address.
- 6 Repeat for all addresses in the PPTP address range.



To add a source address group

Organize the source addresses into an address group.

- 1 Go to **Firewall > Address > Group**.
- 2 Add a new address group to the interface to which PPTP clients connect. This can be an interface, VLAN subinterface, or zone.
- 3 Enter a Group Name to identify the address group. The name can contain numbers (0-9), uppercase and lowercase letters (A-Z, a-z), and the special characters - and _. Other special characters and spaces are not allowed.
- 4 To add addresses to the address group, select an address from the Available Addresses list and select the right arrow to add it to the Members list.
- 5 To remove addresses from the address group, select an address from the Members list and select the left arrow to remove it from the group.
- 6 Select OK to add the address group.

To add a destination address

Add an address to which PPTP users can connect.

- 1 Go to **Firewall > Address**.
- 2 Select the internal interface.
- 3 Select New to add an address.
- 4 Enter the Address Name, IP Address, and NetMask for a single computer or for an entire subnetwork on an internal interface of the local VPN peer.
- 5 Select OK to save the destination address.

To add a firewall policy

Add a policy which specifies the source and destination addresses and sets the service for the policy to the traffic type inside the PPTP VPN tunnel.

- 1 Go to **Firewall > Policy**.
- 2 Select the policy list that you want to add the policy to (usually, External->Internal).
- 3 Select New to add a new policy.
- 4 Set Source to the group that matches the PPTP address range.
- 5 Set Destination to the address to which PPTP users can connect.

- 6 Set Service to match the traffic type inside the PPTP VPN tunnel. For example, if PPTP users can access a web server, select HTTP.
- 7 Set Action to ACCEPT.
- 8 Select NAT if address translation is required. You can also configure traffic shaping, logging, and antivirus and web filter settings for PPTP policies.
- 9 Select OK to save the firewall policy.

Configuring a Windows 98 client for PPTP

Use the following procedure to configure a client computer running Windows 98 so that it can connect to a FortiGate PPTP VPN. To configure the Windows 98 client, you must install and configure Windows dialup networking and virtual private networking support.

To install PPTP support

- 1 Go to **Start > Settings > Control Panel > Network**.
- 2 Select Add.
- 3 Select Adapter.
- 4 Select Add.
- 5 Select Microsoft as the manufacturer.
- 6 Select Microsoft Virtual Private Networking Adapter.
- 7 Select OK twice.
- 8 Insert diskettes or CDs as required.
- 9 Restart the computer.

To configure a PPTP dialup connection

- 1 Go to **My Computer > Dial-Up Networking > Configuration**.
- 2 Double-click Make New Connection.
- 3 Name the connection and select Next.
- 4 Enter the IP address or host name of the FortiGate unit to connect to and select Next.
- 5 Select Finish.
An icon for the new connection appears in the Dial-Up Networking folder.
- 6 Right-click the new icon and select Properties.
- 7 Go to Server Types.
- 8 Uncheck IPX/SPX Compatible.
- 9 Select TCP/IP Settings.
- 10 Uncheck Use IP header compression.
- 11 Uncheck Use default gateway on remote network.
- 12 Select OK twice.

To connect to the PPTP VPN

- 1 Start the dialup connection that you configured in the previous procedure.
- 2 Enter your PPTP VPN User Name and Password.
- 3 Select Connect.

Configuring a Windows 2000 client for PPTP

Use the following procedure to configure a client computer running Windows 2000 so that it can connect to a FortiGate PPTP VPN.

To configure a PPTP dialup connection

- 1 Go to **Start > Settings > Network and Dial-up Connections**.
- 2 Double-click Make New Connection to start the Network Connection Wizard and select Next.
- 3 For Network Connection Type, select Connect to a private network through the Internet and select Next.
- 4 For Destination Address, enter the IP address or host name of the FortiGate unit to connect to and select Next.
- 5 Set Connection Availability to Only for myself and select Next.
- 6 Select Finish.
- 7 In the Connect window, select Properties.
- 8 Select the Security tab.
- 9 Uncheck Require data encryption.
- 10 Select OK.

To connect to the PPTP VPN

- 1 Start the dialup connection that you configured in the previous procedure.
- 2 Enter your PPTP VPN User Name and Password.
- 3 Select Connect.
- 4 In the connect window, enter the User Name and Password that you use to connect to your dialup network connection.
This user name and password is not the same as your VPN user name and password.

Configuring a Windows XP client for PPTP

Use the following procedure to configure a client computer running Windows XP so that it can connect to a FortiGate PPTP VPN.

To configure a PPTP dialup connection

- 1 Go to **Start > Settings > Control Panel**.
- 2 Select Network and Internet Connections.
- 3 Select Create a Connection to the network of your workplace and select Next.
- 4 Select Virtual Private Network Connection and select Next.

- 5 Name the connection and select Next.
- 6 If the Public Network dialog box appears, choose the appropriate initial connection and select Next.
- 7 In the VPN Server Selection dialog, enter the IP address or host name of the FortiGate unit to connect to and select Next.
- 8 Select Finish.

To configure the VPN connection

- 1 Right-click the Connection icon that you created in the previous procedure.
- 2 Select **Properties > Security**.
- 3 Select Typical to configure typical settings.
- 4 Select Require data encryption.



Note: If a RADIUS server is used for authentication do not select Require data encryption. PPTP encryption is not supported for RADIUS server authentication.

- 5 Select Advanced to configure advanced settings.
- 6 Select Settings.
- 7 Select Challenge Handshake Authentication Protocol (CHAP).
- 8 Make sure that none of the other settings are selected.
- 9 Select the Networking tab.
- 10 Make sure that the following options are selected:
 - TCP/IP
 - QoS Packet Scheduler
- 11 Make sure that the following options are not selected:
 - File and Printer Sharing for Microsoft Networks
 - Client for Microsoft Networks
- 12 Select OK.

To connect to the PPTP VPN

- 1 Connect to your ISP.
- 2 Start the VPN connection that you configured in the previous procedure.
- 3 Enter your PPTP VPN User Name and Password.
- 4 Select Connect.
- 5 In the connect window, enter the User Name and Password that you use for your dialup network connection.
This user name and password is not the same as your VPN user name and password.

Configuring L2TP

Some implementations of L2TP support elements of IPSec. These elements must be disabled when L2TP is used with a FortiGate unit.



This section describes:

- [Configuring the FortiGate unit as an L2TP gateway](#)
- [Configuring a Windows 2000 client for L2TP](#)
- [Configuring a Windows XP client for L2TP](#)

Configuring the FortiGate unit as an L2TP gateway

Use the following procedures to configure the FortiGate unit as an L2TP gateway:

To add users and user groups

Add a user for each L2TP client.

- 1 Go to **User > Local**.
- 2 Add and configure L2TP users.
See [“Adding user names and configuring authentication” on page 228](#).
- 3 Go to **User > User Group**.
- 4 Add and configure L2TP user groups.
See [“Configuring user groups” on page 232](#).

To enable L2TP and specify an address range

- 1 Go to **VPN > L2TP > L2TP Range**.
- 2 Select Enable L2TP.
- 3 Enter the Starting IP and the Ending IP for the L2TP address range.
- 4 Select the User Group that you added in [“To add users and user groups” on page 265](#).
- 5 Select Apply to enable L2TP through the FortiGate unit.

Figure 78: Sample L2TP address range configuration

To add source addresses

Add a source address for every address in the L2TP address range.

- 1 Go to **Firewall > Address**.
- 2 Select the interface to which L2TP clients connect.
This can be an interface, VLAN subinterface, or zone.
- 3 Select New to add an address.
- 1 Enter the Address Name, IP Address, and NetMask for an address in the L2TP address range.
- 2 Select OK to save the source address.
- 3 Repeat for all addresses in the L2TP address range.



Note: If the L2TP address range is comprised of an entire subnet, add an address for this subnet. Do not add an address group.

To add a source address group

Organize the source addresses into an address group.

- 1 Go to **Firewall > Address > Group**.
- 2 Add a new address group to the interface to which L2TP clients connect.
This can be an interface, VLAN subinterface, or zone.
- 3 Enter a Group Name to identify the address group.
The name can contain numbers (0-9), uppercase and lowercase letters (A-Z, a-z), and the special characters - and _. Other special characters and spaces are not allowed.
- 4 To add addresses to the address group, select an address from the Available Addresses list and select the right arrow to add it to the Members list.
- 5 To remove addresses from the address group, select an address from the Members list and select the left arrow to remove it from the group.
- 6 Select OK to add the address group.

To add a destination address

Add an address to which L2TP users can connect.

- 1 Go to **Firewall > Address**.
- 2 Select the internal interface.
- 3 Select New to add an address.
- 4 Enter the Address Name, IP Address, and NetMask for a single computer or for an entire subnetwork on an internal interface of the local VPN peer.
- 5 Select OK to save the source address.

To add a firewall policy

Add a policy that specifies the source and destination addresses and sets the service for the policy to the traffic type inside the L2TP VPN tunnel.

- 1 Go to **Firewall > Policy**.

- 2 Select the policy list that you want to add the policy to (usually, External->Internal).
- 3 Select New to add a policy.
- 4 Set Source to the group that matches the L2TP address range.
- 5 Set Destination to the address to which L2TP users can connect.
- 6 Set Service to match the traffic type inside the L2TP VPN tunnel.
For example, if L2TP users can access a web server, select HTTP.
- 7 Set Action to ACCEPT.
- 8 Select NAT if address translation is required.
You can also configure traffic shaping, logging, and antivirus and web filter settings for L2TP policies.
- 9 Select OK to save the firewall policy.

Configuring a Windows 2000 client for L2TP

Use the following procedure to configure a client computer running Windows 2000 so that it can connect to a FortiGate L2TP VPN.

To configure an L2TP dialup connection

- 1 Go to **Start > Settings > Network and Dial-up Connections**.
- 2 Double-click Make New Connection to start the Network Connection Wizard and select Next.
- 3 For Network Connection Type, select Connect to a private network through the Internet and select Next.
- 4 For Destination Address, enter the address of the FortiGate unit to connect to and select Next.
- 5 Set Connection Availability to Only for myself and select Next.
- 6 Select Finish.
- 7 In the Connect window, select Properties.
- 8 Select the Security tab.
- 9 Make sure that Require data encryption is selected.



Note: If a RADIUS server is used for authentication do not select Require data encryption. L2TP encryption is not supported for RADIUS server authentication.

- 10 Select the Networking tab.
- 11 Set VPN server type to Layer-2 Tunneling Protocol (L2TP).
- 12 Save the changes and continue with the following procedure.

To disable IPSec

- 1 Select the Networking tab.
- 2 Select Internet Protocol (TCP/IP) properties.
- 3 Double-click the Advanced tab.

- 4 Go to the Options tab and select IP security properties.
- 5 Make sure that Do not use IPSEC is selected.
- 6 Select OK and close the connection properties window.



Note: The default Windows 2000 L2TP traffic policy does not allow L2TP traffic without IPsec encryption. You can disable default behavior by editing the Windows 2000 Registry as described in the following steps. See the Microsoft documentation for editing the Windows Registry.

- 7 Use the registry editor (regedit) to locate the following key in the registry:
HKEY_LOCAL_MACHINE\System\CurrentControlSet\Services\Rasman\Parameters
- 8 Add the following registry value to this key:
Value Name: ProhibitIpSec
Data Type: REG_DWORD
Value: 1
- 9 Save the changes and restart the computer for the changes to take effect.
You must add the `ProhibitIpSec` registry value to each Windows 2000-based endpoint computer of an L2TP or IPsec connection to prevent the automatic filter for L2TP and IPsec traffic from being created. When the `ProhibitIpSec` registry value is set to 1, your Windows 2000-based computer does not create the automatic filter that uses CA authentication. Instead, it checks for a local or active directory IPsec policy.

To connect to the L2TP VPN

- 1 Start the dialup connection that you configured in the previous procedure.
- 2 Enter your L2TP VPN User Name and Password.
- 3 Select Connect.
- 4 In the connect window, enter the User Name and Password that you use to connect to your dialup network connection.
This user name and password is not the same as your VPN user name and password.

Configuring a Windows XP client for L2TP

Use the following procedure to configure a client computer running Windows XP so that it can connect to a FortiGate L2TP VPN.

To configure an L2TP VPN dialup connection

- 1 Go to **Start > Settings**.
- 2 Select Network and Internet Connections.
- 3 Select Create a connection to the network of your workplace and select Next.
- 4 Select Virtual Private Network Connection and select Next.
- 5 Name the connection and select Next.
- 6 If the Public Network dialog box appears, choose the appropriate initial connection and select Next.

- 7 In the VPN Server Selection dialog, enter the IP address or host name of the FortiGate unit to connect to and select Next.
- 8 Select Finish.

To configure the VPN connection

- 1 Right-click the icon that you created.
- 2 Select **Properties > Security**.
- 3 Select Typical to configure typical settings.
- 4 Select Require data encryption.



Note: If a RADIUS server is used for authentication do not select Require data encryption. L2TP encryption is not supported for RADIUS server authentication.

- 5 Select Advanced to configure advanced settings.
- 6 Select Settings.
- 7 Select Challenge Handshake Authentication Protocol (CHAP).
- 8 Make sure that none of the other settings are selected.
- 9 Select the Networking tab.
- 10 Make sure that the following options are selected:
 - TCP/IP
 - QoS Packet Scheduler
- 11 Make sure that the following options are not selected:
 - File and Printer Sharing for Microsoft Networks
 - Client for Microsoft Networks

To disable IPSec

- 1 Select the Networking tab.
- 2 Select Internet Protocol (TCP/IP) properties.
- 3 Double-click the Advanced tab.
- 4 Go to the Options tab and select IP security properties.
- 5 Make sure that Do not use IPSEC is selected.
- 6 Select OK and close the connection properties window.



Note: The default Windows XP L2TP traffic policy does not allow L2TP traffic without IPSec encryption. You can disable default behavior by editing the Windows XP Registry as described in the following steps. See the Microsoft documentation for editing the Windows Registry.

- 7 Use the registry editor (regedit) to locate the following key in the registry:
 HKEY_LOCAL_MACHINE\System\CurrentControlSet\Services\Rasman\Parameters

- 8 Add the following registry value to this key:

Value Name: ProhibitIpSec

Data Type: REG_DWORD

Value: 1

- 9 Save the changes and restart the computer for the changes to take effect.

You must add the `ProhibitIpSec` registry value to each Windows XP-based endpoint computer of an L2TP or IPSec connection to prevent the automatic filter for L2TP and IPSec traffic from being created. When the `ProhibitIpSec` registry value is set to 1, your Windows XP-based computer does not create the automatic filter that uses CA authentication. Instead, it checks for a local or active directory IPSec policy.

To connect to the L2TP VPN

- 1 Connect to your ISP.
- 2 Start the VPN connection that you configured in the previous procedure.
- 3 Enter your L2TP VPN User Name and Password.
- 4 Select Connect.
- 5 In the connect window, enter the User Name and Password that you use to connect to your dialup network connection.
This user name and password is not the same as your VPN user name and password.

Network Intrusion Detection System (NIDS)

The FortiGate NIDS is a real-time network intrusion detection sensor that uses attack signature definitions to both detect and prevent a wide variety of suspicious network traffic and direct network-based attacks. Also, whenever an attack occurs, the FortiGate NIDS can record the event in a log and send an alert email to the system administrator.

This chapter describes:

- [Detecting attacks](#)
- [Preventing attacks](#)
- [Logging attacks](#)

Detecting attacks

The NIDS Detection module detects a wide variety of suspicious network traffic and network-based attacks. Use the following procedures to configure the general NIDS settings and the NIDS Detection module Signature List.

For the general NIDS settings, you must select which interfaces you want to be monitored for network-based attacks. You also need to decide whether to enable checksum verification. Checksum verification tests the integrity of packets received at the monitored interfaces.

This section describes:

- [Selecting the interfaces to monitor](#)
- [Disabling monitoring interfaces](#)
- [Configuring checksum verification](#)
- [Viewing the signature list](#)
- [Viewing attack descriptions](#)
- [Disabling NIDS attack signatures](#)
- [Adding user-defined signatures](#)

Selecting the interfaces to monitor

To select the interfaces to monitor for attacks

- 1 Go to **NIDS > Detection > General**.
- 2 Select the interfaces to monitor for network attacks.
You can select up to a total of 4 interfaces and VLAN subinterfaces.
- 3 Select Apply.

Disabling monitoring interfaces

To disable monitoring interfaces for attacks

- 1 Go to **NIDS > Detection > General**.
- 2 Clear the check box for all the interfaces that you do not want monitored.
- 3 Select Apply.

Configuring checksum verification

Checksum verification tests the files that pass through the FortiGate unit to make sure that they have not been changed in transit. The NIDS can run checksum verification on IP, TCP, UDP, and ICMP traffic. For maximum detection, you can turn on checksum verification for all types of traffic. However, if the FortiGate unit does not need to run checksum verification, you can turn it off for some or all types of traffic to improve system performance. For example, you might not need to run checksum verification if the FortiGate unit is installed behind a router that also does checksum verification.

To configure checksum verification

- 1 Go to **NIDS > Detection > General**.
- 2 Select the type of traffic that you want to run Checksum Verifications on.
- 3 Select Apply.

Figure 79: Example NIDS detection configuration

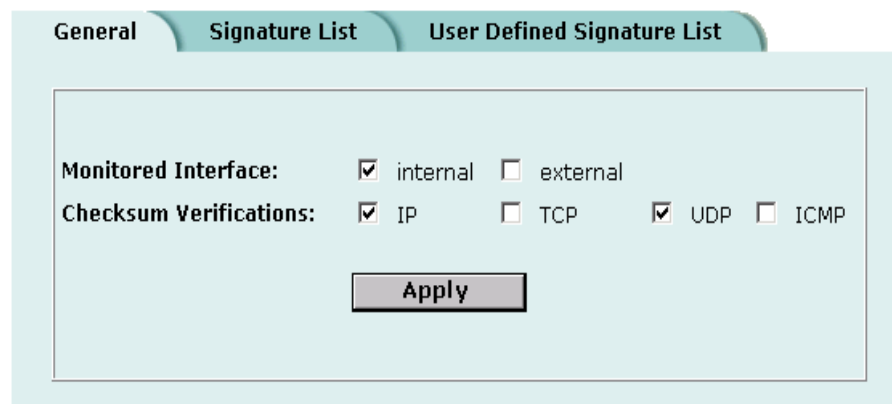

Viewing the signature list

You can display the current list of NIDS signature groups and the members of a signature group.

To view the signature list

- 1 Go to **NIDS > Detection > Signature List**.
- 2 View the names and action status of the signature groups in the list.
The NIDS detects attacks listed in all the signature groups that have check marks in the Enable column.



Note: The user-defined signature group is the last item in the signature list. See [“Adding user-defined signatures” on page 274](#).

- 3 Select View Details  to display the members of a signature group.
The Signature Group Members list displays the attack ID, Rule Name, and Revision number for each group member.

Viewing attack descriptions

Fortinet provides online information for all NIDS attacks. You can view the FortiResponse Attack Analysis web page for an attack listed on the signature list.

To view attack descriptions

- 1 Go to **NIDS > Detection > Signature List**.
- 2 Select View Details  to display the members of a signature group.
- 3 Select a signature and copy its attack ID.
- 4 Open a web browser and enter the following URL:

```
http://www.fortinet.com/ids/ID<attack-ID>
```

Make sure that you include the attack ID.

For example, to view the Fortinet Attack Analysis web page for the `ssh CRC32 overflow /bin/sh` attack (ID 101646338), use the following URL:

```
http://www.fortinet.com/ids/ID101646338
```



Note: Each attack log message includes a URL that links directly to the FortiResponse Attack Analysis web page for that attack. This URL is available in the Attack Log messages and Alert email messages. For information about log message content and formats, and about log locations, see the *FortiGate Logging and Message Reference Guide*. For information about logging attack messages, see [“Logging attacks” on page 278](#).

Figure 80: Example signature group members list

Disabling NIDS attack signatures

By default, all NIDS attack signatures are enabled. You can use the NIDS signature list to disable detection of some attacks. Disabling unnecessary NIDS attack signatures can improve system performance and reduce the number of IDS log messages and alert emails that the NIDS generates. For example, the NIDS detects a large number of web server attacks. If you do not provide access to a web server behind your firewall, you might want to disable all web server attack signatures.

To disable NIDS attack signatures

- 1 Go to **NIDS > Detection > Signature List**.
- 2 Scroll through the signature list to find the signature group that you want to disable. Attack ID numbers and rule names in attack log messages and alert email match those in the signature group members list. You can scroll through a signature group members list to locate specific attack signatures by ID number and name.
- 3 Clear the Enable check box.
- 4 Select OK.
- 5 Repeat steps 2 to 4 for each NIDS attack signature group that you want to disable.

To add user-defined signatures

- 1 Go to **NIDS > Detection > User Defined Signature List**.
- 2 Select Upload .



Caution: Uploading the user-defined signature list overwrites the existing file.

- 3 Type the path and filename of the text file for the user-defined signature list or select Browse and locate the file.
- 4 Select OK to upload the text file for the user-defined signature list.
- 5 Select Return to display the uploaded user-defined signature list.

Figure 81: Example user-defined signature list

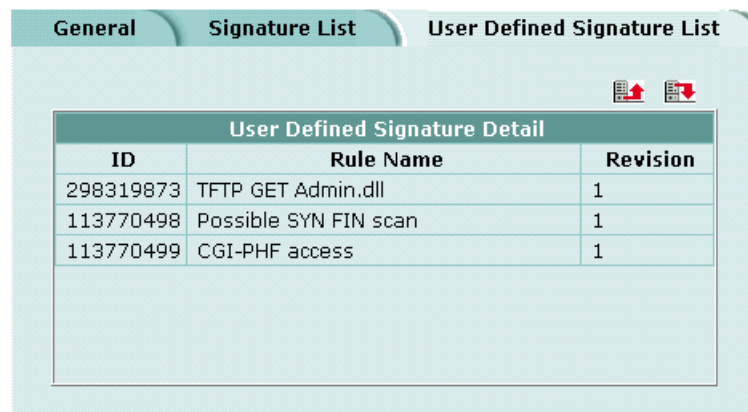

User Defined Signature Detail		
ID	Rule Name	Revision
298319873	TFTP GET Admin.dll	1
113770498	Possible SYN FIN scan	1
113770499	CGI-PHF access	1

Downloading the user-defined signature list

You can back up the user-defined signature list by downloading it to a text file on the management computer.



Note: You cannot download individual signatures. You must download the entire user-defined signature list.

To download the user-defined signature list

- 1 Go to **NIDS > Detection > User Defined Signature List**.
- 2 Select Download.

The FortiGate unit downloads the user-defined signature list to a text file on the management computer. You can specify a location to which to download the text file as well as a name for the text file.

Preventing attacks

NIDS attack prevention protects the FortiGate unit and the networks connected to it from common TCP, ICMP, UDP, and IP attacks. You can enable NIDS attack prevention to prevent a set of default attacks with default threshold values. You can also enable or disable and set the threshold values for individual attack prevention signatures.



Note: After the FortiGate unit reboots, NIDS attack prevention and synflood prevention are always disabled.

- [Enabling NIDS attack prevention](#)
- [Enabling NIDS attack prevention signatures](#)
- [Setting signature threshold values](#)

Enabling NIDS attack prevention



To enable NIDS attack prevention

- 1 Go to **NIDS > Prevention**.
- 2 Select the Enable Prevention check box, in the top left corner.

Enabling NIDS attack prevention signatures

The NIDS Prevention module contains signatures that are designed to protect your network against attacks. Some signatures are enabled by default, others must be enabled. For a complete list of NIDS Prevention signatures and descriptions, see the *FortiGate NIDS Guide*.

To enable attack prevention signatures

- 1 Go to **NIDS > Prevention**.
- 2 Select the Enable check box beside each signature that you want to enable.
- 3 Select Check All  to enable all signatures in the NIDS attack prevention signature list.
- 4 Select Uncheck All  to disable all signatures in the NIDS attack prevention signature list.
- 5 Select Reset to Default Values  to enable only the default NIDS attack prevention signatures and return to the default threshold values.

Setting signature threshold values

You can change the default threshold values for the NIDS Prevention signatures listed in [Table 48](#). The threshold depends on the type of attack. For flooding attacks, the threshold is the maximum number of packets received per second. For overflow attacks, the threshold is the buffer size for the command. For large ICMP attacks, the threshold is the ICMP packet size limit to pass through.



For example, setting the `icmpflood` signature threshold to 500 allows 500 echo requests from a source address, to which the system sends echo replies. The FortiGate unit drops any requests over the threshold of 500.

If you enter a threshold value of 0 or a number out of the allowable range, the FortiGate unit uses the default value.

Table 48: NIDS Prevention signatures with threshold values

Signature abbreviation	Threshold value units	Default threshold value	Minimum threshold value	Maximum threshold value
synflood	Threshold: Maximum number of SYN segments received per second.	2048	1	1000000
	Queue Size: Maximum proxied connections.	4096	100	1000000
	Timeout: Number of seconds for the SYN cookie to keep a proxied connection alive.	15	1	3600
portscan	Maximum number of SYN segments received per second	512	1	1000000
srcsession	Total number of TCP sessions initiated from the same source	2048	1	1000000
ftpovfl	Maximum buffer size for an FTP command (bytes)	256	32	1408
smtpvfl	Maximum buffer size for an SMTP command (bytes)	512	32	1408
pop3ovfl	Maximum buffer size for a POP3 command (bytes)	512	32	1408
udpflood	Maximum number of UDP packets received from the same source or sent to the same destination per second	2048	1	1000000
udpsrcsession	Total number of UDP sessions initiated from the same source	2048	1	1000000
icmpflood	Maximum number of ICMP packets received from the same source or sent to the same destination per second	256	1	1000000
icmpsrcsession	Total number of ICMP sessions initiated from the same source	128	1	1000000
icmpsweep	Maximum number of ICMP packets received from the same source per second	128	1	1000000
icmplarge	Maximum ICMP packet size (bytes)	32000	64	64000

To set Prevention signature threshold values

- 1 Go to **NIDS > Prevention**.
- 2 Select Modify  beside the signature for which you want to set the Threshold value. Signatures that do not have threshold values do not have Modify  icons.
- 3 Type the Threshold value.
- 4 Select the Enable check box.
- 5 Select OK.

Logging attacks

Whenever the NIDS detects or prevents an attack, it generates an attack message. You can configure the system to add the message to the attack log.

- [Logging attack messages to the attack log](#)
- [Reducing the number of NIDS attack log and email messages](#)

Logging attack messages to the attack log

To log attack messages to the attack log

- 1 Go to **Log&Report > Log Setting**.
- 2 Select Config Policy for the log locations you have set.
- 3 Select Attack Log.
- 4 Select Attack Detection and Attack Prevention.
- 5 Select OK.



Reducing the number of NIDS attack log and email messages

Intrusion attempts might generate an excessive number of attack messages. Based on the frequency that messages are generated, the FortiGate unit automatically deletes duplicates. If you still receive an excessive number of unnecessary messages, you can manually disable message generation for unneeded signature groups.

Automatic message reduction

The attack log and alert email messages that the NIDS produces include the ID number and name of the attack that generated the message. The attack ID number and name in the message are identical to the ID number and rule name that appear on the NIDS Signature Group Members list.

The FortiGate unit uses an alert email queue in which each new message is compared with the previous messages. If the new message is not a duplicate, the FortiGate unit sends it immediately and puts a copy in the queue. If the new message is a duplicate, the FortiGate unit deletes it and increases an internal counter for the number of message copies in the queue.

The FortiGate unit holds duplicate alert email messages for 60 seconds. If a duplicate message has been in the queue for more than 60 seconds, the FortiGate unit deletes the message and increases the copy number. If the copy number is greater than 1, the FortiGate unit sends a summary email that includes “Repeated x times” in the subject header, the statement “The following email has been repeated x times in the last y seconds”, and the original message.

Manual message reduction

If you want to reduce the number of alerts that the NIDS generates, you can review the content of attack log messages and alert email. If a large number of the alerts are nuisance alerts (for example, web attacks when you are not running a web server), you can disable the signature group for that attack type. Use the ID number in the attack log or alert email to locate the attack in the signature group list. See [“Disabling NIDS attack signatures” on page 274](#).

Antivirus protection

You can enable antivirus protection in firewall policies. You can select a content profile that controls how the antivirus protection behaves. Content profiles control the type of traffic protected (HTTP, FTP, IMAP, POP3, SMTP), the type of antivirus protection and the treatment of fragmented email and oversized files or email.

This chapter describes:

- [General configuration steps](#)
- [Antivirus scanning](#)
- [File blocking](#)
- [Blocking oversized files and emails](#)
- [Exempting fragmented email from blocking](#)
- [Viewing the virus list](#)

General configuration steps

Configuring antivirus protection involves the following general steps.

- 1 Select antivirus protection options in a new or existing content profile. See [“Adding content profiles” on page 224](#).
- 2 Select the Anti-Virus & Web filter option in firewall policies that allow web (HTTP), FTP, and email (IMAP, POP3, and SMTP) connections through the FortiGate unit. Select a content profile that provides the antivirus protection options that you want to apply to a policy. See [“Adding content profiles to policies” on page 226](#).
- 3 Configure antivirus protection settings to control how the FortiGate unit applies antivirus protection to the web, FTP, and email traffic allowed by policies. See:
 - [“Antivirus scanning” on page 282](#),
 - [“File blocking” on page 283](#),
 - [“Blocking oversized files and emails” on page 285](#),
 - [“Exempting fragmented email from blocking” on page 285](#).
- 4 Configure the messages that users receive when the FortiGate unit blocks or deletes an infected file. See [“Replacement messages” on page 187](#).
- 5 Configure the FortiGate unit to send an alert email when it blocks or deletes an infected file. See [“Configuring alert email” in the *Logging and Message Reference Guide*](#).



Note: For information about receiving virus log messages, see “Configuring logging”, and for information about log message content and format, see “Virus log messages” in the *Logging Configuration and Reference Guide*

Antivirus scanning

Virus scanning intercepts most files (including files compressed with up to 12 layers of compression using zip, rar, gzip, tar, upx, and OLE) in the content streams for which you enable antivirus protection. Each file is tested to determine the file type and the most effective method of scanning the file for viruses. For example, binary files are scanned using binary virus scanning and Microsoft Office files containing macros are scanned for macro viruses.

FortiGate virus scanning does not scan the following file types:

- cdimage
- floppy image
- .ace
- .bzip2
- .Tar+Gzip+Bzip2

If a file is found to contain a virus, the FortiGate unit removes the file from the content stream and replaces it with a replacement message.

To scan FortiGate firewall traffic for viruses

- 1 Select antivirus scanning in a content profile.
For information about content profiles, see [“Adding content profiles” on page 224](#).
- 2 Add this content profile to firewall policies to apply virus scanning to the traffic controlled by the firewall policy.
See [“Adding content profiles to policies” on page 226](#).

Figure 82: Example content profile for virus scanning

Content Profile

New Content Profile

Profile Name:

Options	HTTP	FTP	IMAP	POP3	SMTP
Anti Virus Scan	<input checked="" type="checkbox"/>	<input checked="" type="checkbox"/>	<input checked="" type="checkbox"/>	<input checked="" type="checkbox"/>	<input checked="" type="checkbox"/>
File Block	<input type="checkbox"/>	<input type="checkbox"/>	<input type="checkbox"/>	<input type="checkbox"/>	<input type="checkbox"/>
Web URL Block	<input type="checkbox"/>				
Web Content Block	<input type="checkbox"/>				
Web Script Filter	<input type="checkbox"/>				
Web Exempt List	<input type="checkbox"/>				
Email Block List			<input type="checkbox"/>	<input type="checkbox"/>	
Email Exempt List			<input type="checkbox"/>	<input type="checkbox"/>	
Email Content Block			<input type="checkbox"/>	<input type="checkbox"/>	
Oversized File/Email	<input type="radio"/> block <input checked="" type="radio"/> pass	<input type="radio"/> block <input checked="" type="radio"/> pass	<input type="radio"/> block <input checked="" type="radio"/> pass	<input type="radio"/> block <input checked="" type="radio"/> pass	<input type="radio"/> block <input checked="" type="radio"/> pass
Pass Fragmented Emails			<input type="checkbox"/>	<input type="checkbox"/>	<input type="checkbox"/>

OK Cancel

File blocking

Enable file blocking to remove all files that are a potential threat and to provide the best protection from active computer virus attacks. Blocking files is the only protection from a virus that is so new that antivirus scanning cannot detect it. You would not normally operate the FortiGate unit with blocking enabled. However, it is available for extremely high-risk situations in which there is no other way to prevent viruses from entering your network.

File blocking deletes all files that match a list of enabled file patterns. The FortiGate unit replaces the file with an alert message that is forwarded to the user. The FortiGate unit also writes a message to the virus log and sends an alert email if it is configured to do so.



Note: If both blocking and scanning are enabled, the FortiGate unit blocks files that match enabled file patterns and does not scan these files for viruses.

By default, when blocking is enabled, the FortiGate unit blocks the following file patterns:

- executable files (*.bat, *.com, and *.exe)
- compressed or archive files (*.gz, *.rar, *.tar, *.tgz, and *.zip)
- dynamic link libraries (*.dll)
- HTML application (*.hta)
- Microsoft Office files (*.doc, *.ppt, *.xl?)
- Microsoft Works files (*.wps)
- Visual Basic files (*.vb?)
- screen saver files (*.scr)

Blocking files in firewall traffic

Use content profiles to apply file blocking to HTTP, FTP, POP3, IMAP, and SMTP traffic controlled by firewall policies.

To block files in firewall traffic

- 1 Select file blocking in a content profile.
See [“Adding content profiles” on page 224](#).
- 2 Add this content profile to firewall policies to apply content blocking to the traffic controlled by the firewall policy.
See [“Adding content profiles to policies” on page 226](#).

Adding file patterns to block

To add file patterns to block

- 1 Go to **Anti-Virus > File Block**.
- 2 Select New.
- 3 Type the new pattern in the File Pattern field.
You can use an asterisk (*) to represent any characters and a question mark (?) to represent any single character. For example, *.dot blocks Microsoft Word template files and *.do? blocks both Microsoft Word template files and document files.
- 4 Select the check box beside the traffic protocols for which you want to enable blocking of this file pattern.
- 5 Select OK.

Blocking oversized files and emails

You can configure the FortiGate unit to buffer 1 to 15 percent of available memory to store oversized files and email. The FortiGate unit then blocks a file or email that exceeds this limit instead of bypassing antivirus scanning and sending the file or email directly to the server or receiver. The FortiGate unit sends a replacement message for an oversized file or email attachment to the HTTP or email proxy client.

Configuring limits for oversized files and email

To configure limits for oversized files and email

- 1 Go to **Anti-Virus > Config > Config**.
- 2 Type the size limit, in MB.
- 3 Select Apply.

Exempting fragmented email from blocking

A fragmented email is a large email message that has been split into smaller messages that are sent individually and recombined when they are received. By default, when antivirus protection is enabled, the FortiGate unit blocks fragmented emails and replaces them with an email block message that is forwarded to the receiver. It is recommended that you disable the fragmenting of email messages in the client email software.

To exempt fragmented emails from automatic antivirus blocking



Caution: The FortiGate unit cannot scan fragmented emails for viruses or use file pattern blocking to remove files from these email messages.

- 1 Enable Pass Fragmented Emails for IMAP, POP3, and SMTP traffic in a content profile.
- 2 Select Anti-Virus & Web filter in a firewall policy. For example, to pass fragmented emails that internal users send to the external network, select an internal to external policy.
- 3 Select a content profile that has Pass Fragmented Emails enabled for the traffic that you want the FortiGate unit to scan.

Viewing the virus list

You can view the names of the viruses and worms in the current virus definition list.

To view the virus list

- 1 Go to **Anti-Virus > Config > Virus List**.
- 2 Scroll through the virus and worm list to view the names of all viruses and worms in the list.

Web filtering

When you enable Anti-Virus & Web filter in a firewall policy, you select a content profile that controls how web filtering behaves for HTTP traffic. Content profiles control the following types of content filtering:

- blocking unwanted URLs,
- blocking unwanted content,
- removing scripts from web pages,
- exempting URLs from blocking.

You can also use the Cerberian URL filtering to block unwanted URLs. For more information, see [“Configuring Cerberian URL filtering” on page 294](#).

This chapter describes:

- [General configuration steps](#)
- [Content blocking](#)
- [URL blocking](#)
- [Configuring Cerberian URL filtering](#)
- [Script filtering](#)
- [Exempt URL list](#)

General configuration steps

Configuring web filtering involves the following general steps:

- 1 Select web filtering options in a new or existing content profile. See [“Adding content profiles” on page 224](#).
- 2 Select the Anti-Virus & Web filter option in firewall policies that allow HTTP connections through the FortiGate unit.
 - Select a content profile that provides the web filtering options that you want to apply to a policy. See [“Adding content profiles to policies” on page 226](#).

- 3 Configure web filtering settings to control how the FortiGate unit applies web filtering to the HTTP traffic allowed by policies. See:
 - [“URL blocking” on page 291](#),
 - [“Configuring Cerberian URL filtering” on page 294](#),
 - [“Content blocking” on page 288](#),
 - [“Script filtering” on page 297](#),
 - [“Exempt URL list” on page 298](#).
- 4 Configure the messages that users receive when the FortiGate unit blocks unwanted content or unwanted URLs. See [“Replacement messages” on page 187](#).
- 5 Configure the FortiGate unit to record log messages when it blocks unwanted content or unwanted URLs. See [“Recording logs” on page 307](#).
- 6 Configure the FortiGate unit to send an alert email when it blocks unwanted content or unwanted URLs. See [“Configuring alert email” on page 315](#).

Content blocking



When the FortiGate unit blocks a web page, the user who requested the blocked page receives a block message and the FortiGate unit writes a message to the web filtering log.

You can add banned words to the list in many languages using Western, Simplified Chinese, Traditional Chinese, Japanese, or Korean character sets.

- [Adding words and phrases to the Banned Word list](#)
- [Clearing the Banned Word list](#)
- [Backing up the Banned Word list](#)
- [Restoring the Banned Word list](#)

Adding words and phrases to the Banned Word list

- 1 Go to **Web Filter > Content Block**.
- 2 Select New to add a word or phrase to the Banned Word list.
- 3 Choose a language or character set for the banned word or phrase.
You can choose Western, Chinese Simplified, Chinese Traditional, Japanese, or Korean.
Your computer and web browser must be configured to enter characters in the character set that you choose.

- 4 Type a banned word or phrase.
 If you type a single word (for example, `banned`), the FortiGate unit blocks all web pages that contain that word.
 If you type a phrase (for example, `banned phrase`), the FortiGate unit blocks web pages that contain both words. When this phrase appears on the banned word list, the FortiGate unit inserts plus signs (+) in place of spaces (for example, `banned+phrase`).
 If you type a phrase in quotes (for example, `"banned word"`), the FortiGate unit blocks all web pages in which the words are found together as a phrase.
 Content filtering is not case-sensitive. You cannot include special characters in banned words.
- 5 To enable the banned word, ensure that the Enable checkbox is selected.
- 6 Select OK.
 The word or phrase is added to the Banned Word list.
 You can enable all the words on the banned word list by selecting Check All .
 You can disable all the words on the banned word list by selecting Uncheck All .



Note: Banned Word must be selected in the content profile for web pages containing banned words to be blocked.

Figure 83: Example banned word list

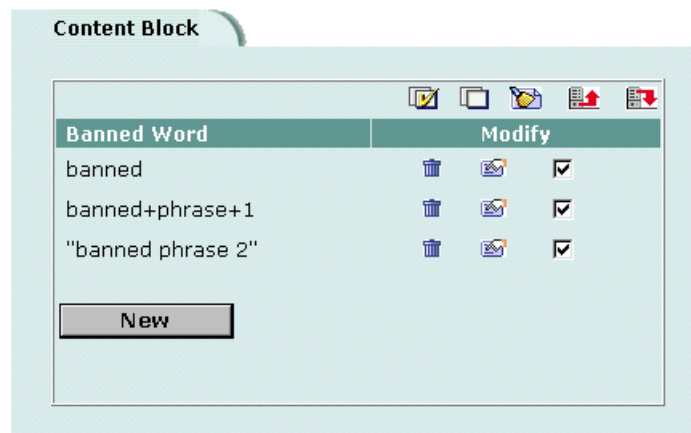

Clearing the Banned Word list

- 1 Go to **Web Filter > Content Block**.
- 2 Select Clear List  to remove all banned words and phrases from the banned word list.

Backing up the Banned Word list

You can back up the banned word list by downloading it to a text file on the management computer.

To back up the banned word list

- 1 Go to **Web Filter > Content Block**.

- 2 Select Backup Banned Word List .

The FortiGate unit downloads the list to a text file on the management computer. You can specify a location to which to download the text file as well as a name for the text file.

Restoring the Banned Word list

You can create a Banned Word list in a text editor and then upload the text file to the FortiGate unit. Add one banned word or phrase to each line of the text file. The word or phrase should be followed by two parameters separated by spaces. The first parameter specifies the status of the entry. The second parameter specifies the language of the entry.

Table 49: Banned Word list configuration parameters

Parameter	Setting	Description
Status	0	Disabled
	1	Enabled
Language	0	ASCII
	1	Simplified Chinese
	2	Traditional Chinese
	3	Japanese
	4	Korean

Figure 84: Example Banned Word List text file

```
banned 1 0
banned+phrase+1 1 3
"banned+phrase+2" 1 1
```



Note: All changes made to the banned word list using the web-based manager are lost when you upload a new list. However, you can download your current banned word list, add more items to it using a text editor, and then upload the edited list to the FortiGate unit.

To restore the banned word list

- 1 Go to **Web Filter > Content Block**.

- 2 Select Restore Banned Word List .

- 3 Type the path and filename of the banned word list text file, or select Browse and locate the file.

- 4 Select OK to upload the file to the FortiGate unit.

- 5 Select Return to display the updated Banned Word List.
- 6 You can continue to maintain the Banned Word List by making changes to the text file and uploading it again as necessary.



Note: Banned Word must be selected in the content profile for web pages containing banned words to be blocked.

URL blocking

You can block the unwanted web URLs using FortiGate Web URL blocking, FortiGate Web pattern blocking, and Cerberian web filtering.

- [Configuring FortiGate Web URL blocking](#)
- [Configuring FortiGate Web pattern blocking](#)
- [Configuring Cerberian URL filtering](#)

Configuring FortiGate Web URL blocking

You can configure FortiGate Web URL blocking to block all pages on a website by adding the top-level URL or IP address. You can also block individual pages on a website by including the full path and filename of the web page to block.

- [Adding URLs to the Web URL block list](#)
- [Clearing the Web URL block list](#)
- [Downloading the Web URL block list](#)
- [Uploading a URL block list](#)

Adding URLs to the Web URL block list

- 1 Go to **Web Filter > Web URL Block**.
- 2 Select New to add a URL to the Web URL block list.
- 3 Type the URL the you want to block.

Type a top-level URL or IP address to block access to all pages on a website. For example, `www.badsite.com` or `122.133.144.155` blocks access to all pages at this website.

Type a top-level URL followed by the path and filename to block access to a single page on a website. For example, `www.badsite.com/news.html` or `122.133.144.155/news.html` blocks the news page on this website.

To block all pages with a URL that ends with `badsite.com`, add `badsite.com` to the block list. For example, adding `badsite.com` blocks access to `www.badsite.com`, `mail.badsite.com`, `www.finance.badsite.com`, and so on.









Note: Do not use regular expressions in the Web URL block list. You can use regular expressions in the Web Pattern Block list to create URL patterns to block. See [“Configuring FortiGate Web pattern blocking”](#) on page 294.



Note: You can type a top-level domain suffix (for example, “com” without the leading period) to block access to all URLs with this suffix.



Note: URL blocking does not block access to other services that users can access with a web browser. For example, URL blocking does not block access to `ftp://ftp.badsite.com`. Instead, you can use firewall policies to deny FTP connections.

- 4 Ensure that the Enable checkbox has been selected and then select OK.
- 5 Select OK to add the URL to the Web URL block list.
You can enter multiple URLs and then select Check All  to enable all items in the Web URL block list.
You can disable all of the URLs on the list by selecting Uncheck All .
Each page of the Web URL block list displays 100 URLs.
- 6 Use Page Up  and Page Down  to navigate through the Web URL block list.



Note: You must select the Web URL Block option in the content profile to enable the URL blocking.

Figure 85: Example URL block list

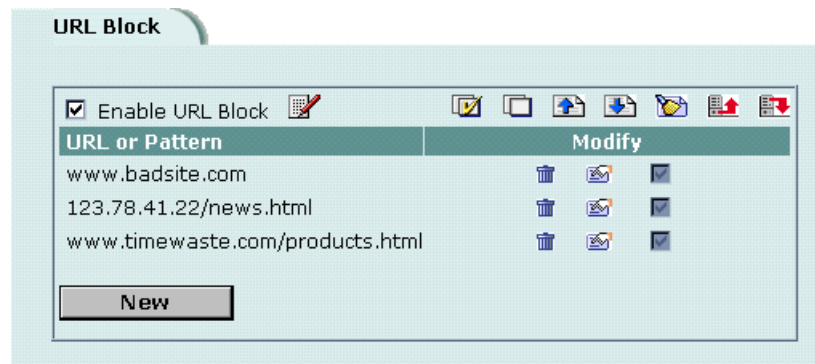

Clearing the Web URL block list

- 1 Go to **Web Filter > Web URL Block**.
- 2 Select Clear URL Block List  to remove all URLs and patterns from the Web URL block list.

Downloading the Web URL block list

You can back up the Web URL block list by downloading it to a text file on the management computer.

To download a Web URL block list

- 1 Go to **Web Filter > Web URL Block**.
- 2 Select Download URL Block List .

The FortiGate unit downloads the list to a text file on the management computer. You can specify a location to which to download the text file as well as a name for the text file.

Uploading a URL block list

You can create a URL block list in a text editor and then upload the text file to the FortiGate unit. Add one URL or pattern to each line of the text file. You can follow the item with a space and then a 1 to enable or a zero (0) to disable the URL. If you do not add this information to the text file, the FortiGate unit automatically enables all URLs and patterns that are followed by a 1 or no number when you upload the text file.

Figure 86: Example URL block list text file



```
www.badsite.com/index 1
www.badsite.com/products 1
182.63.44.67/index 1
```

You can either create the URL block list or add a URL list created by a third-party URL block or blacklist service. For example, you can download the squidGuard blacklists available at <http://www.squidguard.org/blacklist/> as a starting point for creating a URL block list. Three times per week, the squidGuard robot searches the web for new URLs to add to the blacklists. You can upload the squidGuard blacklists to the FortiGate unit as a text file, with only minimal editing to remove comments at the top of each list and to combine the lists that you want into a single file.



Note: All changes made to the URL block list using the web-based manager are lost when you upload a new list. However, you can download your current URL block list, add more items to it using a text editor, and then upload the edited list to the FortiGate unit.

To upload a URL block list

- 1 In a text editor, create the list of URLs and patterns that you want to block.
- 2 Using the web-based manager, go to **Web Filter > Web URL Block**.
- 3 Select Upload URL Block List .
- 4 Type the path and filename of the URL block list text file, or select Browse and locate the file.
- 5 Select OK to upload the file to the FortiGate unit.
- 6 Select Return to display the updated Web URL block list.
Each page of the Web URL block list displays 100 URLs.
- 7 Use Page Down  and Page Up  to navigate through the Web URL block list.

- 8 You can continue to maintain the Web URL block list by making changes to the text file and uploading it again.

Configuring FortiGate Web pattern blocking

You can configure FortiGate web pattern blocking to block web pages that match a URL pattern. Create URL patterns using regular expressions (for example, `badsite.*` matches `badsite.com`, `badsite.org`, `badsite.net` and so on).

FortiGate web pattern blocking supports standard regular expressions. You can add up to 20 patterns to the web pattern block list.

To add patterns to the Web pattern block list

- 1 Go to **Web Filter > URL Block > Web Pattern Block**.
- 2 Select **New** to add an item to the Web pattern block list.
- 3 Type the web pattern that you want to block.
You can use standard regular expressions for web patterns.



Note: URL blocking does not block access to other services that users can access with a web browser. For example, URL blocking does not block access to `ftp://ftp.badsite.com`. Instead, you can use firewall policies to deny FTP connections.

- 4 Select **Enable** to block the pattern.
- 5 Select **OK** to add the pattern to the Web pattern block list.



Note: You must select the **Web URL Block** option in the content profile to enable the URL blocking.

Configuring Cerberian URL filtering

The FortiGate unit supports Cerberian URL filtering. For information about Cerberian URL filtering, see www.cerberian.com.



If you have purchased the Cerberian web filtering functionality with your FortiGate unit, use the following configuration procedures to configure FortiGate support for Cerberian web filtering.

- [Installing a Cerberian license key](#)
- [Adding a Cerberian user](#)
- [Configuring Cerberian web filter](#)
- [Enabling Cerberian URL filtering](#)

Installing a Cerberian license key

Before you can use the Cerberian web filter, you must install a license key. The license key determines the number of end users allowed to use Cerberian web filtering through the FortiGate unit.

To install a Cerberian licence key

- 1 Go to **Web Filter > URL Block**.
- 2 Select Cerberian URL Filtering.
- 3 Enter the license number.
- 4 Select Apply.

Adding a Cerberian user

The Cerberian web policies can be applied only to user groups. You can add users on the FortiGate unit and then add the users to user groups on the Cerberian administration web site.

When the end user tries to access a URL, the FortiGate unit checks whether the user's IP address is in the IP address list on the FortiGate unit. If the user's IP address is in the list, the request is sent to the Cerberian server. Otherwise, an error message is sent to the user saying that the user does not have authorized access to the Cerberian web filter.

To add a Cerberian user

- 1 Go to **Web Filter > URL Block**.
- 2 Select Cerberian URL Filtering.
- 3 Select New.
- 4 Enter the IP address and netmask of the user computers.
You can enter the IP address of a single user. For example, 192.168.100.19 255.255.255.255. You can also enter a subnet of a group of users. For example, 192.168.100.0 255.255.255.0.
- 5 Enter an alias for the user.
The alias is used as the user name when you add the user to a user group on the Cerberian server. If you do not enter an alias, the user's IP is used and added to the default group on the Cerberian server.
- 6 Select OK.

Configuring Cerberian web filter

After you add the Cerberian web filter users on the FortiGate unit, you can add these users to the user groups on the Cerberian web filter server. Then you can create policies and apply these policies to the user groups.

About the default group and policy

There is a default user group, which is associated with a default policy, that exists on the Cerberian web filter server.

You can add users to the default group and apply any policies to the group.

Use the default group to add:

- All the users who are not assigned alias names on the FortiGate unit.
- All the users who are not assigned to other user groups.

The Cerberian web filter groups URLs into 53 categories. The default policy blocks the URLs of 12 categories. You can modify the default policy and apply it to any user groups.

To configure Cerberian web filtering

- 1 Add the user name, which is the alias you added on the FortiGate unit, to a user group on the Cerberian server.
Web policies can be applied only to user groups. If you did not enter an alias for a user's IP address on the FortiGate unit, the user's IP address is automatically added to the default Cerberian group.
- 2 Create policies by selecting the web categories that you want to block.
- 3 Apply the policy to a user group that contains the user.
For detailed procedures, see the online help on the Cerberian Web Filter web page.

Enabling Cerberian URL filtering

After you add the Cerberian users and groups and configure the Cerberian web filter, you can enable Cerberian URL filtering.

To enable cerberian URL filtering

- 1 Go to **Web Filter > URL Block > Cerberian URL Filtering**.
- 2 Select the Cerberian URL Filtering option.
- 3 Go to **Firewall > Content Profile**.
- 4 Create a new or select an existing content profile and enable Web URL Block.
- 5 Go to **Firewall > Policy**.
- 6 Create a new or select an existing policy.
- 7 Select Anti-Virus & Web filter.
- 8 Select the content profile from the Content Profile list.
- 9 Select OK.

Script filtering

You can configure the FortiGate unit to remove Java applets, cookies, and ActiveX scripts from the HTML web pages.



Note: Blocking any of these items might prevent some web pages from working properly.

- [Enabling script filtering](#)
- [Selecting script filter options](#)

Enabling script filtering

- 1 Go to **Firewall > Content Profile**.
- 2 Select the content profile for which you want to enable script filtering.
- 3 Select Script Filter.
- 4 Select OK.

Selecting script filter options

- 1 Go to **Web Filter > Script Filter**.
- 2 Select the script filter options that you want to enable.
You can block Java applets, cookies, and ActiveX.
- 3 Select Apply.

Figure 87: Example script filter settings to block Java applets and ActiveX

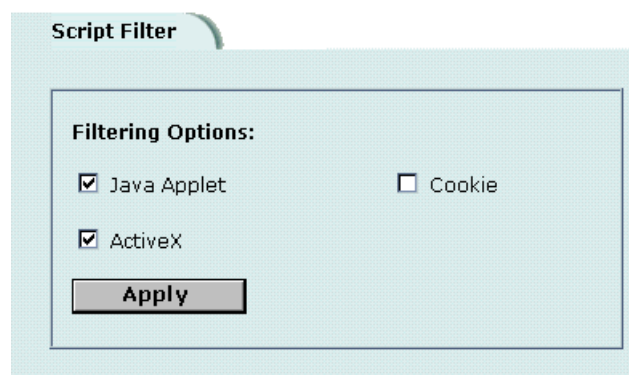

Exempt URL list

Add URLs to the exempt URL list to allow legitimate traffic that might otherwise be blocked by content or URL blocking. For example, if content blocking is set to block pornography-related words and a reputable website runs a story on pornography, web pages from the reputable website are blocked. Adding the address of the reputable website to the exempt URL list allows the content of the website to bypass content blocking.



Note: Content downloaded from exempt web pages is not blocked or scanned by antivirus protection.

- [Adding URLs to the URL Exempt list](#)
- [Downloading the URL Exempt List](#)
- [Uploading a URL Exempt List](#)

Adding URLs to the URL Exempt list

- 1 Go to **Web Filter > URLExempt**.
- 2 Select New to add an item to the URL Exempt list.
- 3 Type the URL to exempt.

Type a complete URL, including path and filename, to exempt access to a page on a website. For example, `www.goodsite.com/index.html` exempts access to the main page of this example website. You can also add IP addresses; for example, `122.63.44.67/index.html` exempts access to the main web page at this address. Do not include `http://` in the URL to exempt.

Exempting a top-level URL, such as `www.goodsite.com`, exempts all requested subpages (for example, `www.goodsite.com/badpage`) from all content and URL filtering rules.



Note: Exempting a top-level URL does not exempt pages such as `mail.goodsite.com` from all content and URL filtering rules unless `goodsite.com` (without the `www`) is added to the exempt URL list.





- 4 Ensure that the Enable checkbox has been selected.
- 5 Select OK to add the URL to the exempt URL list.
You can enter multiple URLs and then select Check All  to activate all items in the exempt URL list.
You can disable all the URLs in the list by selecting Uncheck All .
- 6 Use Page Down  and Page Up  to navigate the exempt URL list.

Figure 88: Example URL Exempt list



Downloading the URL Exempt List

You can back up the URL Exempt List by downloading it to a text file on the management computer.

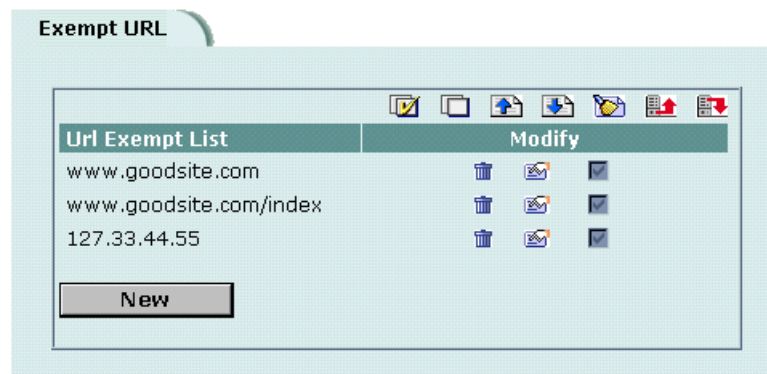
- 1 Go to **Web Filter > URL Exempt**.
- 2 Select Download URL Exempt List .

The FortiGate unit downloads the list to a text file on the management computer. You can specify a location to which to download the text file as well as a name for the text file.

Uploading a URL Exempt List

You can create a URL Exempt list in a text editor and then upload the text file to the FortiGate unit. Add one URL or pattern to each line of the text file. The word or phrase should be followed by a parameter specifying the status of the entry. If you do not add this information to the text file, the FortiGate unit automatically enables all URLs and patterns that are followed with a 1 or no number when you upload the text file.

Table 50: URL Exempt list configuration parameters

Parameter	Setting	Description
Status	0	Disabled
	1	Enabled

Figure 89: Example URL Exempt list text file

```
www.goodsite.com 1
www.goodsite.com/index 1
127.33.44.55 1
```



Note: All changes made to the URL block list using the web-based manager are lost when you upload a new list. However, you can download your current URL block list, add more items to it using a text editor, and then upload the edited list to the FortiGate unit.

- 1 In a text editor, create the list of URLs to exempt.
- 2 Using the web-based manager, go to **Web Filter > URL Exempt**.

- 3 Select Upload URL Exempt List .
- 4 Type the path and filename of your URL Exempt List text file, or select Browse and locate the file.
- 5 Select OK to upload the file to the FortiGate unit.
- 6 Select Return to display the updated URL Exempt List.
- 7 You can continue to maintain the URL Exempt List by making changes to the text file and uploading it again as necessary.

Email filter

Email filtering is enabled in firewall policies. When you enable Anti-Virus & Web filter in a firewall policy, you select a content profile that controls how email filtering behaves for email (IMAP and POP3) traffic. Content profiles control the following types of protection to identify unwanted email:

- filtering unwanted sender address patterns,
- filtering unwanted content,
- exempting sender address patterns from blocking.

This chapter describes:

- [General configuration steps](#)
- [Email banned word list](#)
- [Email block list](#)
- [Email exempt list](#)
- [Adding a subject tag](#)

General configuration steps

Configuring email filtering involves the following general steps:

- 1 Select email filter options in a new or existing content profile. See [“Adding content profiles” on page 224](#).
- 2 Select the Anti-Virus & Web filter option in firewall policies that allow IMAP and POP3 connections through the FortiGate unit. Select a content profile that provides the email filtering options that you want to apply to a policy. See [“Adding content profiles to policies” on page 226](#).
- 3 Add a subject tag to the unwanted email so that receivers can use their mail client software to filter messages based on the tag. See [“Adding a subject tag” on page 306](#).



Note: For information about receiving email filter log messages, see “Configuring logging” in the *Logging Configuration and Reference Guide*. For information about email filter log message categories and formats, see “Log messages” in the *FortiGate Logging Configuration and Reference Guide*.

Email banned word list

When the FortiGate unit detects an email that contains a word or phrase in the banned word list, the FortiGate unit adds a tag to the subject line of the email and writes a message to the event log. Receivers can then use their mail client software to filter messages based on the subject tag.

You can add banned words to the list in many languages using Western, Simplified Chinese, Traditional Chinese, Japanese, or Korean character sets.

- [Adding words and phrases to the email banned word list](#)
- [Downloading the email banned word list](#)
- [Uploading the email banned word list](#)

Adding words and phrases to the email banned word list

To add a word or phrase to the banned word list

- 1 Go to **Email Filter > Content Block**.
- 2 Select **New**.
- 3 Type a banned word or phrase.
 - If you type a single word (for example, `banned`), the FortiGate unit tags all IMAP and POP3 email that contains that word.
 - If you type a phrase (for example, `banned phrase`), the FortiGate unit tags email that contains both words. When this phrase appears on the banned word list, the FortiGate unit inserts plus signs (+) in place of spaces (for example, `banned+phrase`).
 - If you type a phrase in quotes (for example, `"banned word"`), the FortiGate unit tags all email in which the words are found together as a phrase.

Content filtering is not case-sensitive. You cannot include special characters in banned words.

- 1 Select the Language for the banned word or phrase.
You can choose Western, Chinese Simplified, Chinese Traditional, Japanese, or Korean.
Your computer and web browser must be configured to enter characters in the language that you select.
- 2 Select **OK**.
The word or phrase is added to the banned word list.



Note: Email Content Block must be selected in the content profile for IMAP or POP3 email containing banned words to be tagged.

Downloading the email banned word list

You can back up the banned word list by downloading it to a text file on the management computer:

To download the banned word list

- 1 Go to **Email Filter > Content Block**.
- 2 Select Download.

The FortiGate unit downloads the banned word list to a text file on the management computer. You can specify a location to which to download the text file as well as a name for the text file.

Uploading the email banned word list

You can create or edit a banned word list in a text file and upload it from your management computer to the FortiGate unit.

Each banned word or phrase must appear on a separate line in the text file. Use ASCII, Western, Chinese Simplified, Chinese Traditional, Japanese, or Korean characters. Your computer and web browser must be configured to enter characters in the character set that you use.

All words are enabled by default. Optionally, you can enter a space and a 1 after the word to enable it, and another space and a number to indicate the language.

- 0 Western
- 1 Chinese Simplified
- 2 Chinese Traditional
- 3 Japanese
- 4 Korean

If you do not add this information to all items in the text file, the FortiGate unit automatically enables all banned words and phrases that are followed with a 1 or no number in the Western language when you upload the text file.

Figure 90: Example Western email banned word list text file

```
banned 1 0
banned+phrase+1 1 0
"banned phrase 2" 1 0
```

To upload the banned word list

- 1 Go to **Email Filter > Content Block**.
- 2 Select Upload.
- 3 Type the path and filename of the banned word list text file or select Browse and locate the file.
- 4 Select OK to upload the banned word list text file.
Select Return to display the banned word list.

Email block list

You can configure the FortiGate unit to tag all IMAP and POP3 protocol traffic sent from unwanted email addresses. When the FortiGate unit detects an email sent from an unwanted address pattern, the FortiGate unit adds a tag to the subject line of the email and writes a message to the email filter log. Receivers can then use their mail client software to filter messages based on the subject tag.

You can tag email from a specific sender address or from all address subdomains by adding the top-level domain name. Alternatively, you can tag email sent from individual subdomains by including the subdomain to block.

- [Adding address patterns to the email block list](#)
- [Downloading the email block list](#)
- [Uploading an email block list](#)

Adding address patterns to the email block list

To add an address pattern to the email block list

- 1 Go to **Email Filter > Block List**.
- 2 Select New.
- 3 Type a Block Pattern.
 - To tag email from a specific email address, type the email address. For example, `sender@abccompany.com`.
 - To tag email from a specific domain, type the domain name. For example, `abccompany.com`.
 - To tag email from a specific subdomain, type the subdomain name. For example, `mail.abccompany.com`.
 - To tag email from an entire organization category, type the top-level domain name. For example, type `com` to tag email sent from all organizations that use `.com` as the top-level domain.
- 4 Select OK to add the address pattern to the Email Block list.

The pattern can contain numbers (0-9), uppercase and lowercase letters (A-Z, a-z), and the special characters - (hyphen), _ (underscore), and @. Spaces and other special characters are not allowed.

Downloading the email block list

You can back up the email block list by downloading it to a text file on the management computer.

To download the email block list

- 1 Go to **Email Filter > Block List**.
- 2 Select Download.

The FortiGate unit downloads the list to a text file on the management computer. You can specify a location to which to download the text file as well as a name for the text file.

Uploading an email block list

You can create an email block list in a text editor and then upload the text file to the FortiGate unit. Add one pattern to each line of the text file. You can follow the pattern with a space and then a 1 to enable or a zero (0) to disable the pattern. If you do not add this information to the text file, the FortiGate unit automatically enables all patterns that are followed with a 1 or no number when you upload the text file.

Figure 91: Example email block list text file

```
mail.badsite.com 1
suredeal.org 1
user1@badsite.com 1
```

You can either create the email block list yourself, or add a block list created by a third-party email blacklist service. For example, you can subscribe to the Realtime Blackhole List service available at <http://mail-abuse.org/rbl/> as a starting point for creating your own email block list. You can upload blacklists to the FortiGate unit as text files, with only minimal editing to remove comments at the top of each list and to combine the lists that you want into a single file.



Note: All changes made to the email block list using the web-based manager are lost when you upload a new list. However, you can download your current email block list, add more patterns to it using a text editor, and then upload the edited list to the FortiGate unit.

To upload the email block list

- 1 In a text editor, create the list of patterns to block.
- 2 Using the web-based manager, go to **Email Filter > Block List**.
- 3 Select Upload.
- 4 Type the path and filename of your email block list text file, or select Browse and locate the file.
- 5 Select OK to upload the file to the FortiGate unit.
- 6 Select Return to display the updated email block list.
- 7 You can continue to maintain the email block list by making changes to the text file and uploading it again.

Email exempt list

Add address patterns to the exempt list to allow legitimate IMAP and POP3 traffic that might otherwise be tagged by email or content blocking. For example, if the email banned word list is set to block email that contains pornography-related words and a reputable company sends email that contains these words, the FortiGate unit would normally add a subject tag to the email. Adding the domain name of the reputable company to the exempt list allows IMAP and POP3 traffic from the company to bypass email and content blocking.

Adding address patterns to the email exempt list

To add an address pattern to the email exempt list

- 1 Go to **Email Filter > Exempt List**.
- 2 Select **New**.
- 3 Type the address pattern that you want to exempt.
 - To exempt email sent from a specific email address, type the email address. For example, `sender@abccompany.com`.
 - To exempt email sent from a specific domain, type the domain name. For example, `abccompany.com`.
 - To exempt email sent from a specific subdomain, type the subdomain name. For example, `mail.abccompany.com`.
 - To exempt email sent from an entire organization category, type the top-level domain name. For example, type `net` to exempt email sent from all organizations that use `.net` as the top-level domain.

The pattern can contain numbers (0-9), uppercase and lowercase letters (A-Z, a-z), and the special characters - (hyphen), _ (underscore), and @. Spaces and other special characters are not allowed.
- 4 Select **OK** to add the address pattern to the email exempt list.

Adding a subject tag

When the FortiGate unit receives email from an unwanted address or email that contains an item in the email banned word list, the FortiGate unit adds a tag to the subject line and sends the message to the destination email address. Email users can use their mail client software to filter the messages based on the subject tag.

To add a subject tag

- 1 Go to **Email Filter > Config**.
- 2 Type the Subject Tag that you want to display in the subject line of email received from unwanted addresses or that contains banned words. For example, type `Unwanted Mail`.



- 3 Select **Apply**.
The FortiGate unit adds the tag to the subject line of all unwanted email.

Logging and reporting

You can configure the FortiGate unit to log network activity from routine configuration changes and traffic sessions to emergency events. You can also configure the FortiGate unit to send alert email messages to inform system administrators about events such as network attacks, virus incidents, and firewall and VPN events.

This chapter describes:

- [Recording logs](#)
- [Filtering log messages](#)
- [Configuring traffic logging](#)
- [Viewing logs saved to memory](#)
- [Configuring alert email](#)

Recording logs

You can configure logging to record logs to one or more of:

- a computer running a syslog server,
- a computer running a WebTrends firewall reporting server,
- the console.

You can also configure logging to record event, attack, antivirus, web filter, and email filter logs to the FortiGate system memory. Logging to memory allows quick access to only the most recent log entries. If the FortiGate unit restarts, the log entries are lost.

You can select the same or different severity levels for each log location. For example, you might want to record only emergency and alert level messages to the FortiGate memory and record all levels of messages on a remote computer.

For information about filtering the log types and activities that the FortiGate unit records, see [“Filtering log messages” on page 310](#). For information about traffic logs, see [“Configuring traffic logging” on page 311](#).

This section describes:

- [Recording logs on a remote computer](#)
- [Recording logs on a NetIQ WebTrends server](#)
- [Recording logs in system memory](#)
- [Log message levels](#)

Recording logs on a remote computer

You can configure the FortiGate unit to record log messages on a remote computer. The remote computer must be configured with a syslog server.

To record logs on a remote computer

- 1 Go to **Log&Report > Log Setting**.
- 2 Select the Log to Remote Host check box to send the logs to a syslog server.
- 3 Type the IP address of the remote computer running syslog server software.
- 4 Type the port number of the syslog server.
- 5 Select the severity level for which you want to record log messages.
The FortiGate unit logs all levels of severity down to, but not lower than, the level you choose. For example, if you want to record emergency, alert, critical, and error messages, select Error.
See [“Log message levels” on page 309](#).
- 6 Select Config Policy.
 - Select the Log type for which you want the FortiGate unit to record logs.
 - For each Log type, select the activities for which you want the FortiGate unit to record log messages.For information about log types and activities, see [“Filtering log messages” on page 310](#) and [“Configuring traffic logging” on page 311](#).
- 7 Select OK.
- 8 Select Apply.

Recording logs on a NetIQ WebTrends server

Use the following procedure to configure the FortiGate unit to record logs on a remote NetIQ WebTrends firewall reporting server for storage and analysis. FortiGate log formats comply with WebTrends Enhanced Log Format (WELF) and are compatible with WebTrends NetIQ Security Reporting Center 2.0 and Firewall Suite 4.1. For more information, see the Security Reporting Center and Firewall Suite documentation.



Note: FortiGate traffic log messages include sent and received fields, which are optional but required for drawing a WebTrends graph.

To record logs on a NetIQ WebTrends server

- 1 Go to **Log&Report > Log Setting**.
- 2 Select the Log in WebTrends Enhanced Log Format check box.
- 3 Type the IP address of the NetIQ WebTrends firewall reporting server.
- 4 Select the severity level for which you want to record log messages.
The FortiGate logs all levels of severity down to, but not lower than, the level you choose. For example, if you want to record emergency, alert, critical, and error messages, select Error.
See [“Log message levels” on page 309](#).

- 5 Select Config Policy.
To configure the FortiGate unit to filter the types of logs and events to record, use the procedures in [“Filtering log messages” on page 310](#) and [“Configuring traffic logging” on page 311](#).
- 6 Select OK.
- 7 Select Apply.

Recording logs in system memory

If your FortiGate unit does not contain a hard disk, you can configure the FortiGate unit to reserve some system memory for storing current event, attack, antivirus, web filter, and email filter log messages. Logging to memory allows quick access to only the most recent log entries. The FortiGate unit can store a limited number of messages in system memory. After all available memory is used, the FortiGate unit deletes the oldest messages. If the FortiGate unit restarts, the log entries are lost.



Note: The FortiGate unit can record only the event and attack log messages in system memory.

To record logs in system memory

- 1 Go to **Log&Report > Log Setting**.
- 2 Select the Log to memory check box.
- 3 Select the severity level for which you want to record log messages.
The FortiGate logs all levels of severity down to, but not lower than, the level you choose. For example, if you want to record emergency, alert, critical, and error messages, select Error.
See [“Log message levels” on page 309](#).
- 4 Select Config Policy.
To configure the FortiGate to filter the types of logs and events to record, use the procedures in [“Filtering log messages” on page 310](#).
- 5 Select Apply.

Log message levels

[Table 51](#) lists and describes FortiGate log message levels.

Table 51: FortiGate log message levels

Levels	Description	Generated by
0 - Emergency	The system has become unstable.	Emergency messages not available.
1 - Alert	Immediate action is required.	NIDS attack log messages.
2 - Critical	Functionality is affected.	DHCP
3 - Error	An error condition exists and functionality could be affected.	Error messages not available.
4 - Warning	Functionality could be affected.	Antivirus, Web filter, email filter, and system event log messages.
5 - Notice	Information about normal events.	Antivirus, Web filter, and email filter log messages.
6 - Information	General information about system operations.	Antivirus, Web filter, email filter log messages, and other event log messages.

Filtering log messages

You can configure the logs that you want to record and the message categories that you want to record in each log.

To filter log entries

- 1 Go to **Log&Report > Log Setting**.
- 2 Select Config Policy for the log location that you selected in [“Recording logs” on page 307](#).
- 3 Select the log types that you want the FortiGate unit to record.

Traffic Log	Record all connections to and through the interface. To configure traffic filtering, see “Adding traffic filter entries” on page 313 .
Event Log	Record management and activity events in the event log. Management events include changes to the system configuration as well as administrator and user logins and logouts. Activity events include system activities, such as VPN tunnel establishment and HA failover events.
Virus Log	Record virus intrusion events, such as when the FortiGate unit detects a virus, blocks a file type, or blocks an oversized file or email.
Web Filtering Log	Record activity events, such as URL and content blocking, and exemption of URLs from blocking.
Attack Log	Record attacks detected by the NIDS and prevented by the NIDS Prevention module.
Email Filter Log	Record activity events, such as detection of email that contains unwanted content and email from unwanted senders.
Update	Record log messages when the FortiGate connects to the FDN to download antivirus and attack updates.

- 4 Select the message categories that you want the FortiGate unit to record if you selected Event Log, Virus Log, Web Filtering Log, Attack Log, Email Filter Log, or Update in step 3.
- 5 Select OK.

Figure 92: Example log filter configuration

The screenshot shows the 'Local Log Filter' dialog box in the FortiGate configuration interface. The 'Traffic Filter' tab is selected. The dialog contains the following categories and sub-items:

- Traffic Log**
- Event Log**
 - When configuration has changed
 - IPSec negotiation event
 - DHCP service event
 - PPP service event
 - Admin login/logout event
 - IP/MAC binding event
 - System activity event
 - HA activity event
 - Firewall authentication event
 - Route gateway event
- Virus Log**
 - Virus infected
 - Filename blocked
 - File oversized
- Web Filtering Log**
 - Content block
 - URL block
 - URL exempt
- Attack Log**
 - Attack Detection
 - Attack Prevention
- Email Filter Log**
 - Blocklist email detected
 - Banned word detected
- Update**
 - Failed update
 - Successful update
 - FDN error

At the bottom of the dialog are 'OK' and 'Cancel' buttons.

Configuring traffic logging

You can configure the FortiGate unit to record traffic log messages for connections to:

- An interface
- A VLAN subinterface
- A firewall policy

The FortiGate unit can filter traffic logs for a source and destination address and service. You can also enable the following global settings:

- resolve IP addresses to host names,
- display the port number or service.

The traffic filter list displays the name, source address and destination address, and the protocol type of the traffic to be filtered.

This section describes:

- [Enabling traffic logging](#)
- [Configuring traffic filter settings](#)
- [Adding traffic filter entries](#)

Enabling traffic logging

You can enable logging on any interface, VLAN subinterface, and firewall policy.

Enabling traffic logging for an interface

If you enable traffic logging for an interface, all connections to and through the interface are recorded in the traffic log.

To enable traffic logging for an interface

- 1 Go to **System > Network > Interface**.
- 2 Select Edit  in the Modify column beside the interface for which you want to enable logging.
- 3 For Log, select Enable.
- 4 Select OK.
- 5 Repeat this procedure for each interface for which you want to enable logging.

Enabling traffic logging for a VLAN subinterface

If you enable traffic logging for a VLAN subinterface, all connections to and through the VLAN subinterface are recorded in the traffic log.

To enable traffic logging for a VLAN subinterface

- 1 Go to **System > Network > Interface**.
- 2 Select Edit  in the Modify column beside the VLAN subinterface for which you want to enable logging.
- 3 For Log, select Enable.
- 4 Select OK.
- 5 Repeat this procedure for each VLAN subinterface for which you want to enable logging.

Enabling traffic logging for a firewall policy

If you enable traffic logging for a firewall policy, all connections accepted by the firewall policy are recorded in the traffic log.

To enable traffic logging for a firewall policy

- 1 Go to **Firewall > Policy**.
- 2 Select a policy tab.
- 3 Select Log Traffic.
- 4 Select OK.

Configuring traffic filter settings

You can configure the information recorded in all traffic log messages.

To configure traffic filter settings

- 1 Go to **Log&Report > Log Setting > Traffic Filter**.
- 2 Select the settings that you want to apply to all traffic log messages.

Resolve IP Select Resolve IP if you want traffic log messages to list the IP address and domain name stored on the DNS server. If the primary and secondary DNS server addresses provided to you by your ISP have not already been added, go to **System > Network > DNS** and add the addresses.

Display Select Port Number if you want traffic log messages to list the port number, for example, 80/tcp. Select Service Name if you want traffic log messages to list the name of the service, for example, TCP.

- 3 Select Apply.

Figure 93: Example traffic filter list

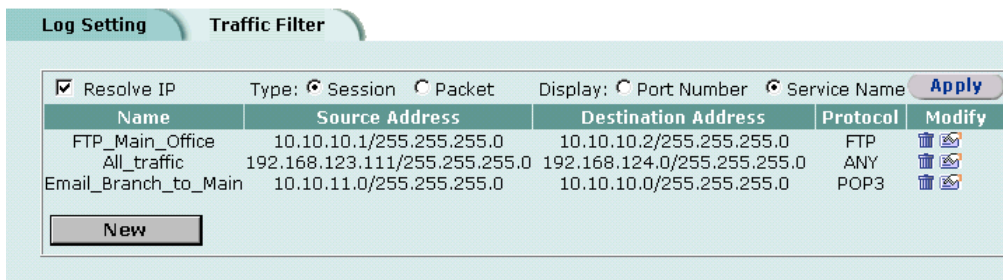

Adding traffic filter entries

Add entries to the traffic filter list to filter the messages that are recorded in the traffic log. If you do not add any entries to the traffic filter list, the FortiGate unit records all traffic log messages. You can add entries to the traffic filter list to limit the traffic logs that are recorded. You can log traffic with a specified source IP address and netmask, to a destination IP address and netmask, and for a specified service. A traffic filter entry can include any combination of source and destination addresses and services.

To add an entry to the traffic filter list

- 1 Go to **Log&Report > Log Setting > Traffic Filter**.
- 2 Select New.
- 3 Configure the traffic filter for the type of traffic that you want to record on the traffic log.

Name Type a name to identify the traffic filter entry. The name can contain numbers (0-9), uppercase and lowercase letters (A-Z, a-z), and the special characters - and _. Spaces and other special characters are not allowed.

Source IP Address Type the source IP address and netmask for which you want the FortiGate unit to log traffic messages. The address can be an individual computer, subnetwork, or network.

Source Netmask

Destination IP Address Type the destination IP address and netmask for which you want the FortiGate unit to log traffic messages. The address can be an individual computer, subnetwork, or network.

Destination Netmask

Service Select the service group or individual service for which you want the FortiGate unit to log traffic messages.

- 4 Select OK.

The traffic filter list displays the new traffic address entry with the settings that you selected in [“Enabling traffic logging” on page 312](#).

Figure 94: Example new traffic address entry

The screenshot shows a 'New Traffic' configuration window. The fields are as follows:

Field	Value
Name	FTP_Main_Office
Source IP Address	10.10.10.1
Source Netmask	255.255.255.0
Destination IP Address	10.10.10.2
Destination Netmask	255.255.255.0
Service	FTP

Viewing logs saved to memory

If the FortiGate unit is configured to save log messages in system memory, you can use the web-based manager to view, search, and clear the log messages. This section describes:

- [Viewing logs](#)
- [Searching logs](#)

Viewing logs

Log messages are listed with the most recent message at the top.

To view log messages saved in system memory

- 1 Go to **Log&Report > Logging**.
- 2 Select Event Log, Attack Log, Antivirus Log, Web Filter Log, or Email Filter Log. The web-based manager lists the log messages saved in system memory.
- 3 Scroll through the log messages to view them.

- 4 To view a specific line in the log, type a line number in the Go to line field and select .
- 5 To navigate through the log message pages, select Go to next page or Go to previous page .

Searching logs

To search log messages saved in system memory

1

Adding alert email addresses

Because the FortiGate unit uses the SMTP server name to connect to the mail server, the FortiGate unit must look up this name on your DNS server. Before you configure alert email, make sure that you configure at least one DNS server.

To add a DNS server

- 1 Go to **System > Network > DNS**.
- 2 If they are not already there, type the primary and secondary DNS server addresses provided by your ISP.
- 3 Select Apply.

To add alert email addresses

- 1 Go to **Log&Report > Alert Mail > Configuration**.
- 2 Select the Authentication check box if your email server requires an SMTP password.
- 3 In the SMTP Server field, type the name of the SMTP server where you want the FortiGate unit to send email, in the format `smtp.domain.com`.
The SMTP server can be located on any network connected to the FortiGate unit.
- 4 In the SMTP User field, type a valid email address in the format `user@domain.com`.
This address appears in the From header of the alert email.
- 5 In the Password field, type the password that the SMTP user needs to access the SMTP server.
A password is required if you select Authentication.
- 6 Type up to three destination email addresses in the Email To fields.
These are the email addresses to which the FortiGate unit sends alert email.
- 7 Select Apply.

Testing alert email

You can test the alert email settings by sending a test email.

To send a test email

- 1 Go to **Log&Report > Alert Mail > Configuration**.
- 2 Select Test to send test email messages from the FortiGate unit to the Email To addresses.

Enabling alert email

You can configure the FortiGate unit to send alert email in response to virus incidents, intrusion attempts, and critical firewall or VPN events or violations. If you have configured logging to a local disk, you can enable sending an alert email when the hard disk is almost full.

To enable alert email

- 1** Go to **Log&Report > Alert Mail > Categories**.
- 2** Select Enable alert email for virus incidents.
Alert email is not sent when antivirus file blocking deletes a file.
- 3** Select Enable alert email for block incidents to have the FortiGate unit send an alert email when it blocks files affected by viruses.
- 4** Select Enable alert email for intrusions to have the FortiGate unit send an alert email to notify the system administrator of attacks detected by the NIDS.
- 5** Select Enable alert email for critical firewall/VPN events or violations to have the FortiGate unit send an alert email when a critical firewall or VPN event occurs.
Critical firewall events include failed authentication attempts.
Critical VPN events include when replay detection detects a replay packet. Replay detection can be configured for both manual key and AutoIKE Key VPN tunnels.
- 6** Select Send alert email when disk is full to have the FortiGate unit send an alert email when the hard disk is almost full.
- 7** Select Apply.

Glossary

Connection: A link between machines, applications, processes, and so on that can be logical, physical, or both.

DMZ, Demilitarized Zone: Used to host Internet services without allowing unauthorized access to an internal (private) network. Typically, the DMZ contains servers accessible to Internet traffic, such as Web (HTTP) servers, FTP servers, SMTP (email) servers and DNS servers.

DMZ interface: The FortiGate interface that is connected to a DMZ network.

DNS, Domain Name Service: A service that converts symbolic node names to IP addresses.

Ethernet: A local-area network (LAN) architecture that uses a bus or star topology and supports data transfer rates of 10 Mbps. Ethernet is one of the most widely implemented LAN standards. A newer version of Ethernet, called 100 Base-T (or Fast Ethernet), supports data transfer rates of 100 Mbps. And the newest version, Gigabit Ethernet, supports data rates of 1 gigabit (1,000 megabits) per second.

External interface: The FortiGate interface that is connected to the Internet. For the FortiGate-60 the external interface is WAN1 or WAN2.

FTP, File transfer Protocol: An application and TCP/IP protocol used to upload or download files.

Gateway: A combination of hardware and software that links different networks. Gateways between TCP/IP networks, for example, can link different subnetworks.

HTTP, Hyper Text Transfer Protocol: The protocol used by the World Wide Web. HTTP defines how messages are formatted and transmitted, and what actions Web servers and browsers should take in response to various commands.

HTTPS: The SSL protocol for transmitting private documents over the Internet using a Web browser.

Internal interface: The FortiGate interface that is connected to an internal (private) network.

Internet: A collection of networks connected together that span the entire globe using the NFSNET as their backbone. As a generic term, it refers to any collection of interdependent networks.

ICMP, Internet Control Message Protocol: Part of the Internet Protocol (IP) that allows for the generation of error messages, test packets, and information messages relating to IP. This is the protocol used by the ping function when sending ICMP Echo Requests to a network host.

IKE, Internet Key Exchange: A method of automatically exchanging authentication and encryption keys between two secure servers.

IMAP, Internet Message Access Protocol: An Internet email protocol that allows access to your email from any IMAP compatible browser. With IMAP, your mail resides on the server.

IP, Internet Protocol: The component of TCP/IP that handles routing.

IP Address: An identifier for a computer or device on a TCP/IP network. An IP address is a 32-bit numeric address written as four numbers separated by periods. Each number can be zero to 255.

L2TP, Layer Two (2) Tunneling Protocol: An extension to the PPTP protocol that enables ISPs to operate Virtual Private Networks (VPNs). L2TP merges PPTP from Microsoft and L2F from Cisco Systems. To create an L2TP VPN, your ISP's routers must support L2TP.

IPSec, Internet Protocol Security: A set of protocols that support secure exchange of packets at the IP layer. IPSec is most often used to support VPNs.

LAN, Local Area Network: A computer network that spans a relatively small area. Most LANs connect workstations and personal computers. Each computer on a LAN is able to access data and devices anywhere on the LAN. This means that many users can share data as well as physical resources such as printers.

MAC address, Media Access Control address: A hardware address that uniquely identifies each node of a network.

MIB, Management Information Base: A database of objects that can be monitored by an SNMP network manager.

Modem: A device that converts digital signals into analog signals and back again for transmission over telephone lines.

MTU, Maximum Transmission Unit: The largest physical packet size, measured in bytes, that a network can transmit. Any packets larger than the MTU are divided into smaller packets before being sent. Ideally, you want the MTU your network produces to be the same as the smallest MTU of all the networks between your machine and a message's final destination. If your messages are larger than one of the intervening MTUs, they get broken up (fragmented), which slows down transmission speeds.

Netmask: Also called subnet mask. A set of rules for omitting parts of a complete IP address to reach a target destination without using a broadcast message. It can indicate a subnetwork portion of a larger network in TCP/IP. Sometimes referred to as an Address Mask.

NTP, Network Time Protocol: Used to synchronize the time of a computer to an NTP server. NTP provides accuracies to within tens of milliseconds across the Internet relative to Coordinated Universal Time (UTC).

Packet: A piece of a message transmitted over a packet-switching network. One of the key features of a packet is that it contains the destination address in addition to the data. In IP networks, packets are often called datagrams.

Ping, Packet Internet Grouper: A utility used to determine whether a specific IP address is accessible. It works by sending a packet to the specified address and waiting for a reply.

POP3, Post Office Protocol: A protocol used to transfer e-mail from a mail server to a mail client across the Internet. Most e-mail clients use POP.

PPP, Point-to-Point Protocol: A TCP/IP protocol that provides host-to-network and router-to-router connections.

PPTP, Point-to-Point Tunneling Protocol: A Windows-based technology for creating VPNs. PPTP is supported by Windows 98, 2000, and XP. To create a PPTP VPN, your ISP's routers must support PPTP.

Port: In TCP/IP and UDP networks, a port is an endpoint to a logical connection. The port number identifies what type of port it is. For example, port 80 is used for HTTP traffic.

Protocol: An agreed-upon format for transmitting data between two devices. The protocol determines the type of error checking to be used, the data compression method (if any), how the sending device indicates that it has finished sending a message, and how the receiving device indicates that it has received a message.

RADIUS, Remote Authentication Dial-In User Service: An authentication and accounting system used by many Internet Service Providers (ISPs). When users dial into an ISP they enter a user name and password. This information is passed to a RADIUS server, which checks that the information is correct, and then authorizes access to the ISP system.

Router: A device that connects LANs into an internal network and routes traffic between them.

Routing: The process of determining a path to use to send data to its destination.

Routing table: A list of valid paths through which data can be transmitted.

Server: An application that answers requests from other devices (clients). Used as a generic term for any device that provides services to the rest of the network such as printing, high capacity storage, and network access.

SMTP, Simple Mail Transfer Protocol: In TCP/IP networks, this is an application for providing mail delivery services.

SNMP, Simple Network Management Protocol: A set of protocols for managing networks. SNMP works by sending messages to different parts of a network. SNMP-compliant devices, called agents, store data about themselves in Management Information Bases (MIBs) and return this data to the SNMP requesters.

SSH, Secure shell: A secure Telnet replacement that you can use to log into another computer over a network and run commands. SSH provides strong secure authentication and secure communications over insecure channels.

Subnet: A portion of a network that shares a common address component. On TCP/IP networks, subnets are defined as all devices whose IP addresses have the same prefix. For example, all devices with IP addresses that start with 100.100.100. would be part of the same subnet. Dividing a network into subnets is useful for both security and performance reasons. IP networks are divided using a subnet mask.

Subnet Address: The part of the IP address that identifies the subnetwork.

TCP, Transmission Control Protocol: One of the main protocols in TCP/IP networks. TCP guarantees delivery of data and also guarantees that packets will be delivered in the same order in which they were sent.

UDP, User Datagram Protocol: A connectionless protocol that, like TCP, runs on top of IP networks. Unlike TCP, UDP provides very few error recovery services, offering instead a direct way to send and receive datagrams over an IP network. It is used primarily for broadcasting messages over a network.

VPN, Virtual Private Network: A network that links private networks over the Internet. VPNs use encryption and other security mechanisms to ensure that only authorized users can access the network and that data cannot be intercepted.

Virus: A computer program that attaches itself to other programs, spreading itself through computers or networks by this mechanism usually with harmful intent.

Worm: A program or algorithm that replicates itself over a computer network, usually through email, and performs malicious actions, such as using up the computer's resources and possibly shutting the system down.

Index

A

- accept
 - policy 196
- action
 - policy option 196
- active log
 - searching 315
- ActiveX 297
 - removing from web pages 297
- address 202
 - adding 202
 - adding firewall addresses to a virtual domain 157
 - editing 203, 204
 - group 204
 - IP/MAC binding 221
 - virtual IP 213
- address group 204
 - example 205
- address name 202
- addressing mode
 - DHCP 144
 - PPPoE 145
- admin access level
 - administrator account 178
- administrative access
 - to an interface 147
- administrative status
 - changing for an interface 143
- administrator account
 - adding 178
 - admin 178
 - changing password 179
 - editing 178, 179
 - netmask 178, 179
 - permission 179
 - trusted host 178, 179
- alert email
 - configuring 316
 - configuring SMTP server 316
 - content of messages 278
 - critical firewall or VPN events 317
 - enabling 317
 - hard disk full 317
 - intrusion attempts 317
 - reducing messages 274
 - testing 316
 - virus incidents 317
- allow inbound
 - encrypt policy 197
- allow outbound
 - encrypt policy 197
- allow traffic
 - IP/MAC binding 221
- Anti-Virus & Web filter
 - policy 198
- antivirus definition updates
 - manual 114
- antivirus definitions
 - updating 123
- antivirus updates 126
 - configuring 127
 - through a proxy server 128
- attack definition updates
 - downloading 139
 - manual 115
- attack definitions
 - updating 123, 125
- attack detection
 - checksum verification 272
 - disabling the NIDS 272
 - enabling and disabling signatures 274
 - selecting interfaces to monitor 272
 - viewing the signature list 273
- attack log 310
 - content of messages 278
 - reducing messages 274
- attack prevention
 - configuring signature threshold values 277
 - enabling prevention signatures 276
 - NIDS 276

- attack updates
 - configuring 127
 - scheduling 126
 - through a proxy server 128
- authentication 198, 227
 - configuring 228
 - enabling 232
 - LDAP server 231
 - RADIUS server 230
 - timeout 176
- auto
 - device in route 160
- AutoIKE 236
 - certificates 236
 - introduction 236
 - pre-shared keys 236
- automatic antivirus and attack definition updates
 - configuring 127

B

- backing up
 - system settings 115
- bandwidth
 - guaranteed 198
 - maximum 198
- banned word list
 - adding words 288, 302
 - restoring 303
- blacklist
 - URL 293, 305
- block traffic
 - IP/MAC binding 221
- blocking
 - access to Internet sites 291, 304
 - access to URLs 291, 304
 - adding filename patterns 284
 - file 283
 - oversized files and email 285
 - URL 291
 - web pages 288, 302
 - web pattern blocking 294

C

- certificates
 - introduction 236
- checksum verification
 - configuring 272
- clearing
 - communication sessions 122
 - URL block list 292
- CLI 21
 - configuring IP addresses 71
 - configuring NAT/Route mode 64
 - upgrading the firmware 103, 105
- command line interface 21
- Comments
 - firewall policy 199
 - policy 199

- connecting
 - to network 65, 73
 - to the FDN 124
 - to the FortiResponse Distribution Network 124
 - web-based manager 44
- contact information
 - registration 138
 - SNMP 181
- content blocking
 - exempting URLs 298, 305
 - web page 288, 302
- content filter 287, 301
- content profiles
 - default 224
- cookies
 - blocking 297
- CPU status 119
- critical firewall events
 - alert email 317
- critical VPN events
 - alert email 317
- custom ICMP service 209
- custom IP service 209
- custom TCP service 208
- custom UDP service 208
- customer service 23

D

- date and time setting
 - example 176, 187
- date setting 175
- default gateway
 - configuring (Transparent mode) 72
- default route 164
- deny
 - firewall policy 196
 - policy 196
- destination
 - policy option 196
- destination route
 - adding 159
 - adding a default route 159
- detection
 - NIDS 271
- device
 - auto 160
- DHCP
 - adding a DHCP server to an interface 163
 - adding a reserved IP to a DHCP server 165
 - adding a scope to a DHCP server 163
 - configuring 162
 - configuring a DHCP server 163
 - configuring DHCP relay 163
 - interface addressing mode 144
 - viewing a dynamic IP list 165
- dialup L2TP
 - configuring Windows 2000 client 267
 - configuring Windows XP client 268

- dialup PPTP
 - configuring Windows 2000 client 263
 - configuring Windows 98 client 262
 - configuring Windows XP client 263
 - dialup VPN
 - viewing connection status 258
 - disabling NIDS 272
 - DMZ interface
 - definition 319
 - DNS
 - server addresses 158
 - domain
 - DHCP 164
 - downloading
 - attack definition updates 139
 - virus definition updates 139
 - dynamic IP list
 - viewing 165
 - dynamic IP pool
 - IP pool 197
 - dynamic IP/MAC list 220
 - viewing 222
- E**
- email alert
 - testing 316
 - email filter log 310
 - enabling policy 201
 - encrypt
 - policy 196
 - encrypt policy
 - allow inbound 197
 - allow outbound 197
 - Inbound NAT 197
 - Outbound NAT 197
 - ending IP address
 - PPTP 260, 265
 - event log 310
 - viewing 314
 - exempt URL list 298, 305
 - adding URL 298, 306
 - exempting URLs from content and URL blocking 298, 305
 - expire
 - system status 122
- F**
- factory default
 - restoring system settings 116
 - FAQs 257
 - FDN
 - connecting to 124
 - FortiResponse Distribution Network 124
 - FDS
 - FortiResponse Distribution Server 124
 - filename pattern
 - adding 284
 - blocking 283
 - filter
 - RIP 171
 - filtering log messages 310
 - filtering traffic 311
 - firewall
 - authentication timeout 176
 - configuring 191
 - introduction 17
 - overview 191
 - firewall address
 - adding to a virtual domain 157
 - firewall events
 - enabling alert email 317
 - firewall policy
 - accept 196
 - adding for a virtual domain 157
 - Comments 199
 - deny 196
 - guaranteed bandwidth 198
 - Log Traffic 199
 - maximum bandwidth 198
 - firewall setup wizard 20, 63, 70
 - starting 63, 70
 - firmware
 - changing 102
 - installing 107
 - re-installing current version 107
 - reverting to an older version 107
 - upgrading 102
 - upgrading to a new version 103
 - upgrading using the CLI 103, 105
 - upgrading using the web-base manager 103, 104
 - first trap receiver IP address
 - SNMP 181
 - fixed port 197
 - FortiCare
 - service contracts 134
 - support contract number 138
 - Fortinet customer service 23
 - Fortinet support
 - recovering a lost password 136
 - FortiResponse Distribution Network 124
 - connecting to 124
 - FortiResponse Distribution Server 124
 - from IP
 - system status 122
 - from port
 - system status 122
- G**
- get community
 - SNMP 181
 - grouping services 209
 - groups
 - address 204
 - user 232
 - guaranteed bandwidth 198

H

- HA 81
 - connecting a NAT/Route mode cluster 84
 - introduction 19
 - managing HA group 87
 - NAT/Route mode 82
 - replacing FortiGate unit after fail-over 95

- hard disk full
 - alert email 317

- high availability 81
 - introduction 19

- HTTP
 - enabling web filtering 287, 301

- HTTPS 20, 206, 319

I

- ICMP 207, 319
 - configuring checksum verification 272

- ICMP service
 - custom 209

- idle timeout
 - web-based manager 176

- IDS log
 - viewing 314

- IKE 319

- IMAP 206, 319

- Inbound NAT
 - encrypt policy 197

- interface
 - adding a DHCP server 163
 - administrative access 147
 - administrative status 143
 - changing administrative status 143
 - DHCP 144
 - management access 147
 - manual IP address 144
 - MTU size 148
 - ping server 146
 - PPPoE 145
 - RIP 169
 - secondary IP address 146
 - traffic logging 148
 - viewing the interface list 143

- internal address
 - example 203

- internal address group
 - example 205

- internal network
 - configuring 66

- Internet
 - blocking access to Internet sites 291, 304
 - blocking access to URLs 291, 304

- Internet key exchange 319

- intrusion attempts
 - alert email 317

- intrusion status 121

IP

- configuring checksum verification 272

- IP address
 - interface 144
 - IP/MAC binding 220

- IP addresses
 - configuring from the CLI 71

- IP pool
 - adding 218

- IP service
 - custom 209

- IP spoofing 220

- IP/MAC binding 220
 - adding 221
 - allow traffic 221
 - block traffic 221
 - dynamic IP/MAC list 220
 - enabling 222
 - static IP/MAC list 220

- IPSec 319

- IPSec VPN
 - authentication for user group 233
 - AutoIKE 236
 - certificates 236
 - disabling 267, 269
 - manual keys 236
 - pre-shared keys 236
 - remote gateway 233
 - status 257
 - timeout 257, 258

- IPSec VPN tunnel
 - testing 258

J

- Java applets 297
 - removing from web pages 297

K

- keyword
 - log search 315

L

- L2TP 233, 319
 - configuring Windows XP client 268

- L2TP gateway
 - configuring 265

- language
 - web-based manager 177

- LDAP
 - example configuration 232

- LDAP server
 - adding server address 231
 - deleting 232

- lease duration
 - DHCP 164

- log message
 - levels 309

- log setting
 - filtering log entries 126, 310
 - traffic filter 313
- log to memory
 - configuring 309
 - viewing saved logs 314
- Log Traffic
 - firewall policy 199
 - policy 199
- logging 21, 307
 - attack log 310
 - configuring traffic settings 312, 313
 - connections to an interface 148
 - email filter log 310
 - enabling alert email 317
 - event log 310
 - filtering log messages 310
 - log to memory 309
 - log to remote host 308
 - log to WebTrends 308
 - message levels 309
 - recording 307
 - searching logs 315
 - selecting what to log 310
 - traffic log 310
 - traffic logging 148
 - traffic sessions 311
 - update log 310
 - virus log 310
 - web filtering log 310
- logs
 - recording on NetIQ WebTrends server 308
- M**
- MAC address 320
 - IP/MAC binding 220
- malicious scripts
 - removing from web pages 297, 306
- management access
 - to an interface 147
- management interface 148
- management IP address
 - transparent mode 71
- manual IP address
 - interface 144
- manual keys
 - introduction 236
- matching
 - policy 200
- maximum bandwidth 198
- memory status 119
- messages
 - replacement 182
- MIB
 - FortiGate 182
- mode
 - Transparent 18
- monitor
 - system status 121
- monitored interfaces 272
- monitoring
 - system status 118
- MTU size 148
 - changing 148
 - definition 320
 - improving network performance 148
 - interface 148
- N**
- NAT
 - introduction 18
 - policy option 197
 - push update 129
- NAT mode
 - adding policy 194
 - IP addresses 64
- NAT/Route mode
 - changing to 117
 - configuration from the CLI 64
 - connecting an HA cluster 84
 - HA 82
 - introduction 18
 - VLANs 151
- netmask
 - administrator account 178, 179
- network address translation
 - introduction 18
- network intrusion detection 18
- Network Intrusion Detection System 271
- network status 120
- next hop router 146
- NIDS 18, 271
 - attack prevention 276
 - detection 271
 - prevention 276
 - reducing alert email 278
 - reducing attack log messages 278
 - user-defined signatures 274
- NTP 66, 72, 207, 320
- NTP server 175
 - setting system date and time 175
- O**
- one-time schedule 211
 - creating 211
- operating mode
 - changing to NAT/Route mode 117
 - changing to Transparent mode 117
- options
 - changing system options 176
- Outbound NAT
 - encrypt policy 197
- override serve
 - adding 126, 127

oversized files and email
blocking 285

P

password
adding 228
changing administrator account 179
Fortinet support 138
recovering a lost Fortinet support 136

PAT 215

pattern
web pattern blocking 294

permission
administrator account 179

ping server
adding to an interface 146

policy
accept 196
adding for a virtual domain 157
Anti-Virus & Web filter 198
arranging in policy list 200
Comments 199
deny 196
disabling 201
enabling 201
enabling authentication 232
fixed port 197
guaranteed bandwidth 198
Log Traffic 199
matching 200
maximum bandwidth 198

policy list
configuring 200

policy routing 161

POP3 207, 320

port address translation 215

port forwarding 215
adding virtual IP 215
virtual IP 213

port number
traffic filter display 313

powering on 40

PPPoE
interface addressing mode 145

PPTP 233, 320
configuring gateway 260, 265
configuring Windows 2000 client 263
configuring Windows 98 client 262
configuring Windows XP client 263
enabling 260, 265
ending IP address 260, 265
starting IP 260, 265

PPTP dialup connection
configuring Windows 2000 client 263
configuring Windows 98 client 262
configuring Windows XP client 263

PPTP gateway
configuring 260

predefined services 205

pre-shared keys
introduction 236

prevention
NIDS 276

protocol
service 205
system status 122

proxy server 128
push updates 128

push update
configuring 128
external IP address changes 129
management IP address changes 129
through a NAT device 129
through a proxy server 128

Q

quick mode identifier
use selectors from policy 245
use wildcard selectors 245
quick mode identity 245

R

RADIUS
definition 320
example configuration 230

RADIUS server
adding server address 230
deleting 230

read & write access level
administrator account 178

read only access level
administrator account 178

recording logs 307

recording logs in system memory 309

recording logs on NetIQ WebTrends server 308

recovering
a lost Fortinet support password 136

recurring schedule 212
creating 212

registered FortiGate units
viewing the list of 137

registering
FortiGate unit 133, 134, 135, 137
FortiGate unit after an RMA 140
list of registered FortiGate units 137

registration
contact information 138
security question 138
updating information 136

relay
DHCP 162, 163

remote administration 147, 148

replacement messages
customizing 182

reporting 21, 307

- reserved IP
 - adding to a DHCP server 165
- resolve IP 313
 - traffic filter 313
- restarting 118
- restoring system settings 116
- restoring system settings to factory default 116
- reverting
 - firmware to an older version 107
- RIP
 - configuring 167
 - filters 171
 - interface configuration 169
 - settings 167
- RMA
 - registering a FortiGate unit 140
- route
 - adding default 159
 - adding to routing table 159
 - adding to routing table (Transparent mode) 160
 - destination 159
 - device 160
- router
 - next hop 146
- routing 320
 - adding static routes 159
 - configuring 158
 - configuring routing table 161
 - policy 161
- routing table 320
 - adding default route 159
 - adding routes 159
 - adding routes (Transparent mode) 160
 - configuring 161
- S**
- scanning
 - antivirus 282
- schedule 210
 - applying to policy 213
 - automatic antivirus and attack definition updates 126
 - creating one-time 211
 - creating recurring 212
 - one-time 211
 - policy option 196
 - recurring 212
- scheduled antivirus and attack updates 128
- scheduled updates
 - through a proxy server 128
- scheduling 126
- scope
 - adding a DHCP scope 163
- script filter 297
 - example settings 297
- scripts
 - removing from web pages 297, 306
- searching logs 315
 - logs saved to memory 314
- secondary IP
 - interface 146
- security question
 - registration 138
- serial number
 - displaying 115
- server
 - DHCP 162, 163
- service 205
 - custom ICMP 209
 - custom IP 209
 - custom TCP 208
 - custom UDP 208
 - group 209
 - policy option 196
 - predefined 205
 - service name 205
 - user-defined ICMP 209
 - user-defined IP 209
 - user-defined TCP 208
 - user-defined UDP 208
- service contracts
 - Forticare 134
- service group
 - adding 210
- service name
 - traffic filter display 313
- session
 - clearing 122
- session list 122
- session status 120
- set time 175
- setup wizard 63, 70
 - starting 63, 70
- shutting down 118
- signature threshold values 277
- SMTP 207
 - configuring alert email 316
 - definition 320
- SNMP
 - configuring 180
 - contact information 181
 - definition 320
 - first trap receiver IP address 181
 - get community 181
 - MIBs 182
 - system location 181
 - trap community 181
 - traps 183
- source
 - policy option 196
- squidGuard 293, 305
- SSH 207, 321
- SSL 319
 - service definition 206
- starting IP
 - DHCP 164, 165
 - PPTP 260, 265
- static IP/MAC list 220

- static NAT virtual IP 213
 - adding 214
- static route
 - adding 159
- status
 - CPU 119
 - interface 143
 - intrusions 121
 - IPSec VPN tunnel 257
 - memory 119
 - network 120
 - sessions 120
 - viewing dialup connection status 258
 - viewing VPN tunnel status 257
 - virus 121
- subnet
 - definition 321
- subnet address
 - definition 321
- support contract number
 - adding 138
 - changing 138
- support password
 - changing 138
- syn interval 175
- synchronize with NTP server 175
- system configuration 175
- system date and time
 - setting 175
- system location
 - SNMP 181
- system name
 - SNMP 181
- system options
 - changing 176
- system settings
 - backing up 115
 - restoring 116
 - restoring to factory default 116
- system status 101, 118, 167
- system status monitor 121

T

- TCP
 - configuring checksum verification 272
 - custom service 208
- technical support 23
- testing
 - alert email 316
- time
 - log search 315
 - setting 175
- time zone 175
- timeout
 - firewall authentication 176
 - idle 176
 - IPSec VPN 257, 258
 - web-based manager 176

- to IP
 - system status 122
- to port
 - system status 122
- traffic
 - configuring global settings 312, 313
 - filtering 311
 - logging 311
- traffic filter
 - adding entries 313
 - display 313
 - log setting 313
 - port number 313
 - resolve IP 313
 - service name 313
- traffic log 310
- Traffic Priority 198
- Traffic Shaping 197
- Transparent mode 18
 - adding routes 160
 - changing to 71, 117
 - configuring the default gateway 72
 - management interface 148
 - management IP address 71
 - virtual domains 153
- trap community
 - SNMP 181
- traps
 - SNMP 183
- troubleshooting 257
- trusted host
 - administrator account 178, 179

U

- UDP
 - configuring checksum verification 272
 - custom service 208
- unwanted content
 - blocking 288, 302
- update 310
 - attack 127
 - push 128
- updated
 - antivirus 127
- updating
 - attack definitions 123, 125
 - virus definitions 123, 125
- upgrade
 - firmware 103
- upgrading
 - firmware 102
 - firmware using the CLI 103, 105
 - firmware using the web-based manager 103, 104
- URL
 - adding to exempt URL list 298, 306
 - adding to URL block list 294, 304
 - blocking access 291, 304

- URL block list
 - adding URL 294, 304
 - clearing 292
 - downloading 290, 293, 299, 304
 - uploading 290, 293, 299, 305
 - URL block message 288
 - URL blocking 291
 - exempt URL list 298, 305
 - web pattern blocking 294
 - URL exempt list
 - see also exempt URL list 298, 305
 - use selectors from policy
 - quick mode identifier 245
 - use wildcard selectors
 - quick mode identifier 245
 - user authentication 227
 - user groups
 - configuring 232
 - deleting 234
 - user name and password
 - adding 229
 - adding user name 228
 - user-defined ICMP services 209
 - user-defined IP services 209
 - user-defined signature
 - NIDS 274
 - user-defined TCP services 208
 - user-defined UDP services 208
- V**
- viewing
 - dialup connection status 258
 - logs saved to memory 314
 - VPN tunnel status 257
 - virtual domain
 - adding 155
 - adding a VLAN 155
 - adding a zone 156
 - adding firewall addresses 157
 - adding firewall policies 157
 - configuring 154
 - configuring in Transparent mode 153
 - deleting 158
 - properties 154
 - virtual IP 213
 - adding 214
 - port forwarding 213, 215
 - static NAT 213
 - virus definition updates
 - downloading 139
 - virus definitions
 - updating 123, 125
 - virus incidents
 - enabling alert email 317
 - virus list
 - displaying 286
 - viewing 286
 - virus log 310
 - virus protection
 - overview 281
 - worm protection 16
 - virus status 121
 - VLAN
 - adding to a virtual domain 155
 - NAT/Route mode 151
 - overview 150
 - rules for VLAN IDs 151
 - rules for VLAN IP addresses 152
 - VPN
 - configuring L2TP gateway 265
 - configuring PPTP gateway 260, 265
 - introduction 19
 - Tunnel 197
 - viewing dialup connection status 258
 - VPN events
 - enabling alert email 317
 - VPN tunnel
 - viewing status 257
- W**
- web content filtering
 - introduction 16
 - web filtering
 - ActiveX 297
 - cookies 297
 - Java applets 297
 - overview 287, 301
 - web filtering log 310
 - web page
 - content blocking 288, 302
 - web pattern blocking 294
 - web URL blocking 291
 - web-based manager 20
 - connecting to 44
 - introduction 20
 - language 177
 - timeout 176
 - WebTrends
 - recording logs on NetIQ WebTrends server 308
 - Windows 2000
 - configuring for L2TP 267
 - configuring for PPTP 263
 - connecting to L2TP VPN 268
 - connecting to PPTP VPN 263
 - Windows 98
 - configuring for PPTP 262
 - connecting to PPTP VPN 263
 - Windows XP
 - configuring for L2TP 268
 - configuring for PPTP 263
 - connecting to L2TP VPN 270
 - connecting to PPTP VPN 264
 - wizard
 - setting up firewall 63, 70
 - starting 63, 70

worm list
 displaying 286
worm protection 286

Z

zone
 adding 142
 adding to a virtual domain 156
 configuring 141